





TRES







2023

Designed and produced in Barcelona









CARACTERÍSTICAS

-  Novedad
-  Desagüe automático incluido
-  Válvula Simple-Rapid incluida
-  Barra de ducha telescópica
-  Indicado para personas con discapacidades físicas
-  Funciona con alimentación eléctrica
-  Funciona con alimentación a pilas
-  Rociador de latón
-  Rociador de acero inoxidable
-  Rociador de ABS
-  Ducha de mano de latón
-  Ducha de mano de acero inoxidable
-  Ducha de mano de ABS









RECAMBIOS

-  Cartucho (referencia del recambio)
-  Montura (referencia del recambio)
-  Distribuidor (referencia del recambio)
-  Volante + cartucho (referencia del recambio)

INDICACIONES

-  Ángulo de giro del caño
-  Excentricidad especial
-  Funciones del rociador (litros/minuto)
-  Funciones de la ducha de mano (litros/minuto)
-  Funciones de los jets (litros/minuto)
-  Tiempo de apertura (en segundos)
-  Frío (indicador del volante)
-  Caliente (indicador del volante)

TECNOLOGÍA

-  Ducha con sistema de Cromoterapia
-  Cartucho Tres Therm 77®
-  Cartucho Tres Instant 77®
-  Cartucho Tres Instant 57®
-  Touch-Cool®: La superficie del grifo siempre está fría
-  Easy-Clean®: Fácil acceso y mantenimiento del cartucho
-  Cold-Tres®: El grifo siempre se abre con agua fría
-  Tres-Duo®: En la posición intermedia se consume la mitad

TRÉS

2023

Los productos mostrados en este catálogo pueden sufrir leves modificaciones por exigencias de diseño, siempre en beneficio del artículo.

Los precios de este catálogo son recomendados de venta al público y no incluyen el IVA.

Ante posibles errores de impresión, los precios revisados y definitivos aparecen siempre en la web de Tres.

Para conocer la disponibilidad de los productos, consulte la página web.

A través de la página web puede estar al día de las novedades de Tres o consultar si un producto ha sido descatalogado.

CONTENIDO

010 COLECCIONES

Exclusive

- 014 **N** Mont Blanc
- 020 Tres Clasic
- 040 Slim
- 054 Study
- 072 Cuadro

Selection

- 092 Loft
- 106 **N** Fuji
- 116 Project-tres
- 130 Max
- 146 Lex-Alp
- 160 Class

Essential

- 170 Flat
- 180 Canigó Plus
- 192 Canigó
- 202 Base Plus
- 212 Base
- 220 Ese-23

226 ESPACIO DE DUCHA

Electrónicos

- 228 Shower technology

Termostáticos

- 242 **N** Empotrados B-system
- 252 **N** Empotrados Therm-box
- 272 **N** Murales Over-wall

Monomandos

- 290 Empotrados 3V
- 298 **N** Empotrados Rapid-box
- 322 Empotrados
- 336 Murales
- 346 Borde de bañera

354 COMPLEMENTOS DE DUCHA

- 362 Rociadores
- 381 Duchas de mano
- 387 Flexos
- 390 Barras deslizantes
- 399 Kits de ducha
- 404 Soportes y tomas de pared
- 407 Codo adaptador a pared
- 408 Jets

412 ACCESORIOS DE BAÑO

- 414 Cuadrado
- 415 Redondo
- 416 Clásico

418 TECNOLOGÍA ELECTRÓNICA

- 420 Shower Technology
- 429 Lavabos
- 435 Dispensadores de jabón
- 436 Sensores WC
- 437 Cocina electrónica

438 ESPACIO DE COCINA

- 444 Monomandos
- 454 A muro
- 457 Con caño flexible
- 458 Para tratamiento de agua
- 460 Con caño extraíble
- 462 Con caño abatible
- 462 Bimandos
- 466 Industriales
- 468 Electrónicos
- 469 Grifos para varios usos

470 COLECTIVIDADES

- 472 Grifos temporizados
- 477 Grifos medicales
- 478 Grifos para peluquería
- 479 Grifos para exterior

482 COMPLEMENTOS DE GRIFERÍA

- 484 Válvulas y desagües
- 494 Sifones
- 497 Llaves de paso
- 499 Connexiones acodadas y alargaderas
- 501 Caños
- 504 Florones
- 505 Excéntricas
- 506 Válvulas de vaciado
- 508 WC Systems
 - 510 Mecanismos de llenado
 - 511 Mecanismos de descarga
- 514 Tres Cleaner
 - 516 Limpiador de grifería

518 ANEXO

- 520 Instalación recomendada
- 523 Nuevos diseños de volantes
- 524 Recambios
- 528 Listado de referencias
- 540 Condiciones de venta



Toda invención tiene su origen

Tres inició su actividad en 1968 en la zona vinícola del Penedès (España).

La incursión por parte de la empresa en el sector de la grifería empezó cuando su fundador, Jaume Tres, revolucionó el sector del vino con un nuevo grifo para barricas que mejoraba el cierre hermético.

Este nuevo grifo evitaba pérdidas de vino y entradas de aire innecesarias eliminando la espuma al salir.

A partir de la creación de grifos para barricas de vino surge el espíritu industrial de Tres y una larga trayectoria de invención y diseño para crear las mejores experiencias para baño y cocina.





Fundada el 1968, Tres es una empresa familiar dedicada al diseño, fabricación y comercialización de grifos para baño y cocina y otras soluciones para el uso del agua.

Con presencia a nivel global, desde la factoría central situada en Vallirana (Barcelona) se producen más de 3000 modelos distintos de grifería con el objetivo de dar respuesta a las necesidades de los usuarios fabricando productos accesibles a todos donde el diseño y la experiencia de uso ayuden a hacer más agradable el consumo responsable del agua.





Espíritu industrial

Para garantizar la máxima calidad en sus productos, Tres controla todo el proceso de fabricación en sus instalaciones, desde que se concibe la idea, hasta que se hace realidad. El espíritu de Tres queda patente en cada grifo cuidando su diseño y mejorando la tecnología, para ofrecer un producto único, actual y funcional, con gran variedad de soluciones para todas aquellas personas que buscan confort.



1 Diseño



2 Ingeniería



3 Laboratorio



4 Fundición



5 Mecanizado



6 Pulido



7 Acabado



8 Montaje

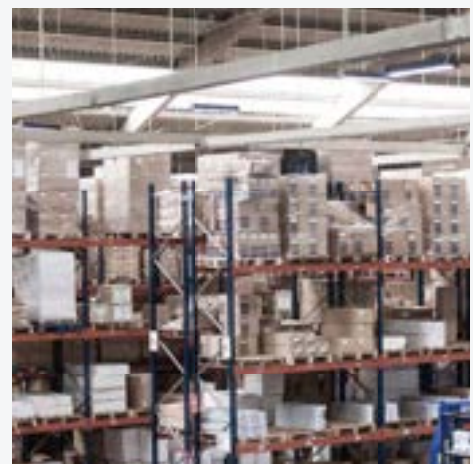

9 Expedición

COLD-TRES® AHORRO DE ENERGÍA



Sistema de bajo consumo energético en el que el grifo se abre siempre con agua fría, evitando el encendido innecesario del calentador.

Al abrir la maneta en posición central, sólo se consume agua fría y es el consumidor quien decide cuando quiere utilizar agua caliente desplazando la maneta hacia la izquierda, lo que supone un bajo consumo de energía.

Ideado y patentado por Tres desde 1992.

TRES-DUO® AHORRO DE AGUA



Sistema de bajo consumo de agua con una apertura de la maneta en dos posiciones. En la posición intermedia se consume el 50% del agua.

El 90% de las veces que utilizamos un grifo en el lavabo o en la cocina no tenemos la necesidad de utilizar el caudal máximo. Con este sistema obtenemos un menor consumo de agua y energía.

Ideado y patentado por Tres desde 2010.

TRES TOUCH-COOL®

SISTEMA DE SEGURIDAD ANTIQUEMADURAS

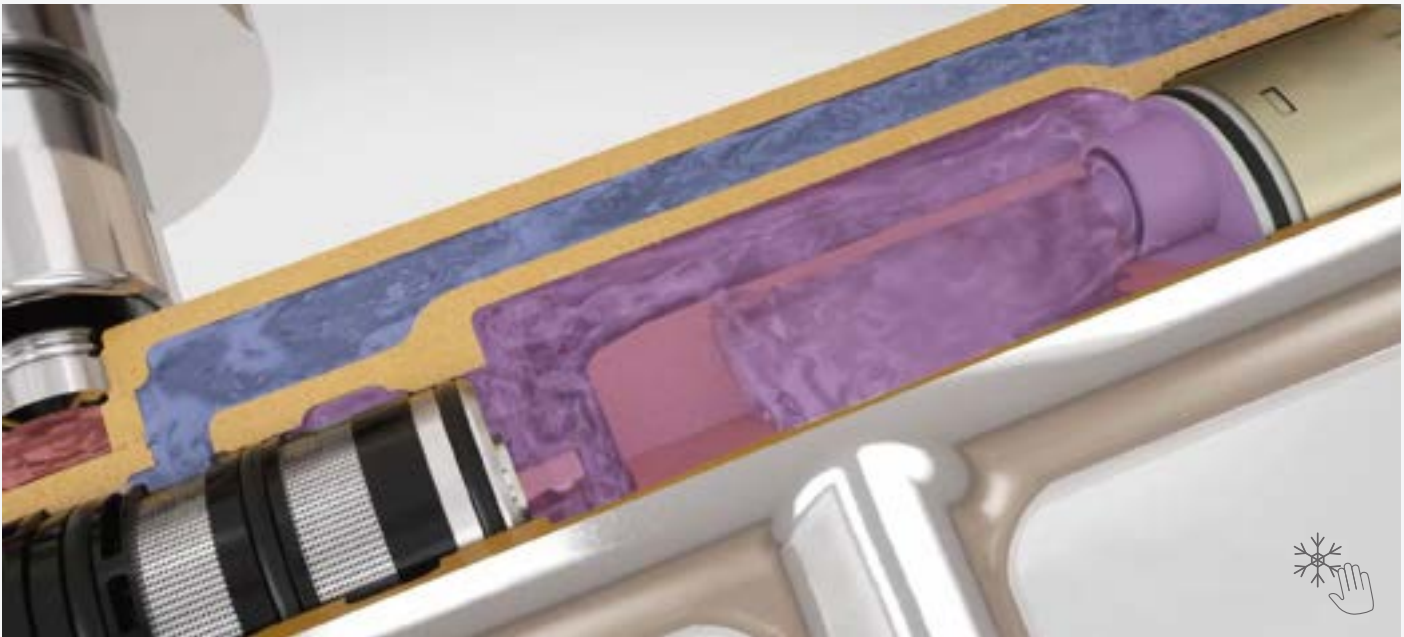

Tres Touch-cool® es un sistema que consigue mantener la superficie del grifo a una temperatura apta para el tacto, evitando quemaduras.

Es un sistema de seguridad especialmente interesante cuando los usuarios son niños o personas mayores, ya que son estos los que tienen un riesgo más elevado de tocar el grifo.



CR Cromado

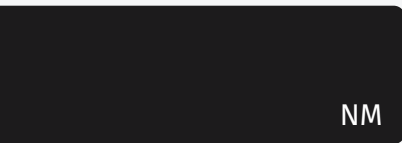

NM Negro mate



BM Blanco mate



AC Acero



KM Negro metalizado



KMB Negro bronce



OR Oro 24k



OM Oro mate 24k



OP Oro Rosa 24k



^NOPM Oro Rosa mate 24k



LV Latón viejo



LM Latón viejo mate









	Mont Blanc	Tres Classic	Slim	Study	Cuadro	Loft	Fuji	Project-tres	Max	Lex/Alp	Class	Flat	Canigó Plus	Canigó	Base Plus	Base	Ese-23	Shower technology	B-system	Therm-box	Over-wall	Rapid-box	Accesorios	Cocina
	14	20	40	54	72	92	106	116	130	146	160	170	180	192	202	212	220	228	242	252	272	298	412	438
CR		✓	✓	✓	✓	✓	✓	✓	✓	✓	✓	✓	✓	✓	✓	✓	✓	✓	✓	✓	✓	✓	✓	✓
NM		✓		✓	✓	✓	✓	✓							✓			✓	✓	✓	✓	✓	✓	✓
BM				✓	✓	✓		✓												✓	✓	✓	✓	✓
AC		✓	✓	✓	✓	✓	✓	✓											✓	✓	✓	✓	✓	✓
KM				✓				✓												✓		✓	✓	
KMB				✓				✓												✓	✓	✓	✓	
OR			✓	✓	✓	✓		✓											✓	✓		✓	✓	✓
OM		✓		✓	✓	✓		✓										✓	✓	✓	✓	✓	✓	✓
OP				✓				✓											✓	✓		✓	✓	
OPM		✓		✓				✓										✓	✓	✓	✓	✓	✓	
LV			✓																				✓	✓
LM			✓																				✓	✓
TAM				✓																				
TRO				✓																				
NE					✓	✓																		
BL					✓	✓																		









COLECCIONES









EXCLUSIVE

	Mont Blanc	014
	Tres Clasic	020
	Slim	040
	Study	054
	Cuadro	072

SELECTION

	Loft	092
	Fuji	106
	Project-tres	116
	Max	130
	Lex-Alp	146
	Class	160

ESSENTIAL

	Flat	170
	Canigó Plus	180
	Canigó	192
	Base Plus	202
	Base	212
	Ese-23	220



MONT BLANC

La colección Mont Blanc de Tres parte de una arquitectura simétrica construida bajo las premisas del diseño, la funcionalidad y el cuidado de todos los detalles. Con los característicos volantes en forma de cruz, esta revisión de la estética clásica permite más adaptabilidad y convierte sus piezas en algo atemporal y genuino.

Acabados disponibles:



CR



NM



AC



OM



OPM









GRIFOS PARA LAVABO

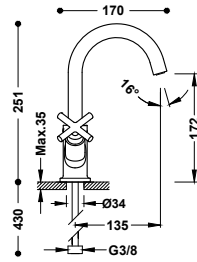

Grifo bimando para lavabo

Con volantes. Latiguillos de alimentación flexibles G3/8.

- 28310301
- 28310301NM
- 28310301AC
- 28310301OM
- 28310301OPM



29916402 29916403

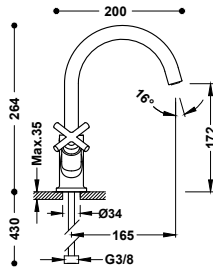

Grifo bimando alto para lavabo

Con volantes. Latiguillos de alimentación flexibles G3/8.

- 28320301
- 28320301NM
- 28320301AC
- 28320301OM
- 28320301OPM



29916402 29916403

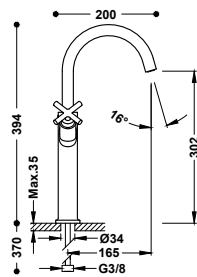

Grifo bimando XXL para lavabo

Con volantes. Latiguillos de alimentación flexibles G3/8.

- 28380301
- 28380301NM
- 28380301AC
- 28380301OM
- 28380301OPM



29916402 29916403

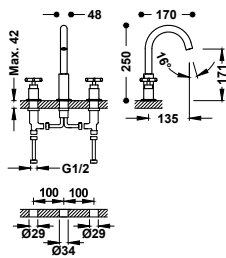

Grifo bimando de repisa para lavabo

De instalación libre. Con volantes.

- 28310501
- 28310501NM
- 28310501AC
- 28310501OM
- 28310501OPM



29916402 29916403

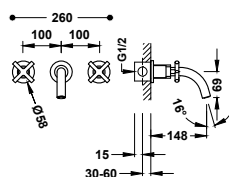

Grifo bimando empotrado para lavabo

Cuerpo empotrado incluido e indivisible. Con volantes. Caño de 148 mm.

- 28330001
- 28330001NM
- 28330001AC
- 28330001OM
- 28330001OPM



29916402 29916403

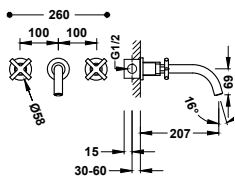

Grifo bimando empotrado para lavabo

Cuerpo empotrado incluido e indivisible. Con volantes. Caño de 207 mm.



- 28330002
- 28330002NM
- 28330002AC
- 28330002OM
- 28330002OPM

GRIFOS PARA BIDE

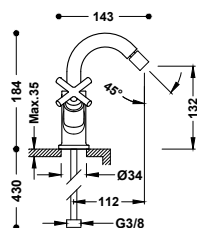

Grifo bimando para bidé

Rótula orientable. Con volantes. Latiguillos de alimentación flexibles G3/8.

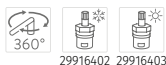

- 28312001
- 28312001NM
- 28312001AC
- 28312001OM
- 28312001OPM

GRIFOS MURALES

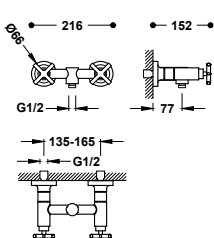

Grifo bimando mural para ducha

Ducha de mano anticalcárea de latón. Soporte orientable para ducha de mano. Flexo satinado.

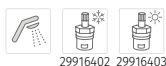

- 28316301
- 28316301NM
- 28316301AC
- 28316301OM
- 28316301OPM

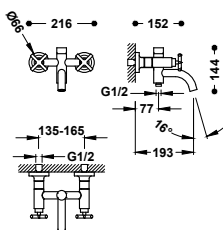

Grifo bimando mural para bañera y ducha

Ducha de mano anticalcárea de latón. Soporte orientable para ducha de mano. Flexo satinado.



- 28317601
- 28317601NM
- 28317601AC
- 28317601OM
- 28317601OPM





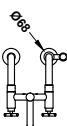
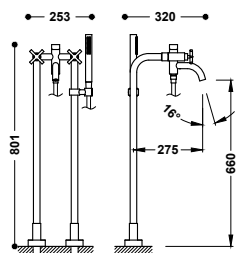

GRIFOS PARA BAÑERA



Grifo bimando de suelo para bañera y ducha

Con 2 columnas verticales de alimentación de agua a suelo. Ducha de mano anticalcárea de latón. Soporte fijo para ducha de mano. Flexo satinado.

-  28319401
-  28319401NM
-  28319401AC
-  28319401OM
-  28319401OPM

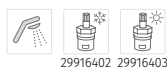

GRIFO TERMOSTÁTICO EMPOTRADO THERM-BOX

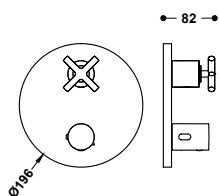

Pieza vista para caja empotrada de 2 vías Therm-box

Sólo parte vista. Volante en cruz. Incluye placa embellecedora, mando y volante distribuidor. Completar con la caja empotrada Therm-box ref.: 20785001.

-  28325001
-  28325001NM
-  28325001AC
-  28325001OM
-  28325001OPM



Caja empotrada de 2 vías Therm-box con grifo termostático para ducha y bañera

20785001



TRES CLASIC

Su diseño se inspira en la grifería clásica pero con la tecnología actual. Con la colección Clasic de Tres se consigue el ambiente rústico, clásico y elegante que buscas. Los acabados especiales que presenta son perfectos para completar un baño inspirador.

Acabados disponibles:



CR AC OR LV LM









GRIFOS PARA LAVABO

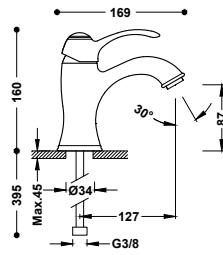

Grifo monomando para lavabo

Latiguillos de alimentación flexibles G3/8.



9134592

24210301

- 24210301AC
- 24210301OR
- 24210301LV
- 24210301LM

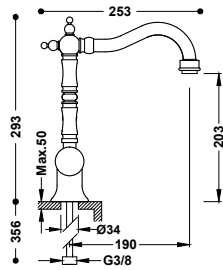

Grifo monomando con maneta lateral para lavabo

Latiguillos de alimentación flexibles G3/8.



9134591

24210801

- 24210801AC
- 24210801OR
- 24210801LV
- 24210801LM

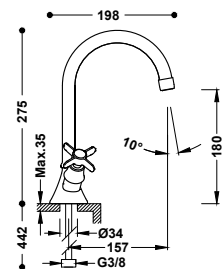

Grifo bimando para lavabo

Con volantes. Latiguillos de alimentación flexibles G3/8.



9134282

24210901

- 24210901AC
- 24210901OR
- 24210901LV
- 24210901LM

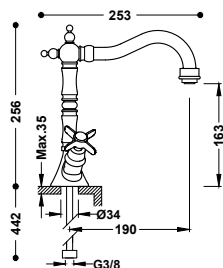

Grifo bimando para lavabo

Con volantes. Latiguillos de alimentación flexibles G3/8.



9134282

24210902

- 24210902AC
- 24210902OR
- 24210902LV
- 24210902LM

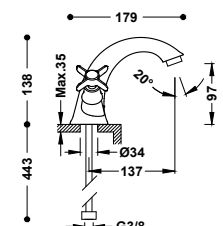

Grifo bimando para lavabo

Con volantes. Latiguillos de alimentación flexibles G3/8.



9134282

24210201

- 24210201AC
- 24210201OR
- 24210201LV
- 24210201LM

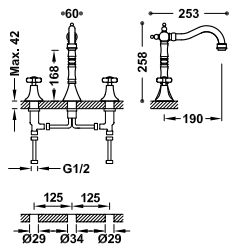

Grifo bimando de repisa para lavabo

De instalación libre. Con volantes.



9134282

24210501

- 24210501AC
- 24210501OR
- 24210501LV
- 24210501LM

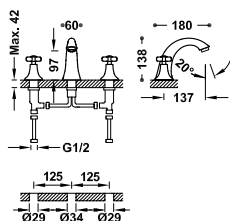

Grifo bimando de repisa para lavabo

De instalación libre. Con volantes.



9134282

24210601

- 24210601AC
- 24210601OR
- 24210601LV
- 24210601LM

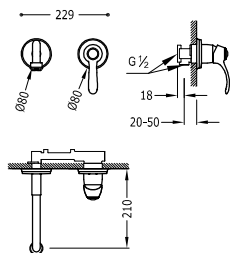

Grifo monomando empotrado para lavabo

Cuerpo empotrado incluido e indivisible. Caño de 210 mm.



9134592

24220001

- 24220001AC
- 24220001OR
- 24220001LV
- 24220001LM

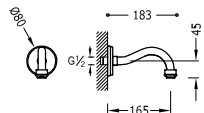

Caño fijo de pared

Long: 165 mm.

24217302

- 24217302AC
- 24217302OR
- 24217302LV
- 24217302LM

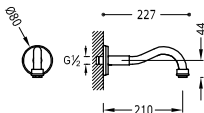

Caño fijo de pared

Long: 210 mm.

24217301

- 24217301AC
- 24217301OR
- 24217301LV
- 24217301LM



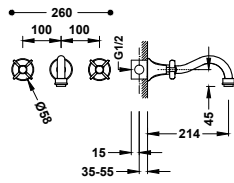

Grifo bimando empotrado para lavabo

Cuerpo empotrado incluido e indivisible. Con volantes. Caño de 214 mm.

■ 24215101

- 24215101AC
- 24215101OR
- 24215101LV
- 24215101LM

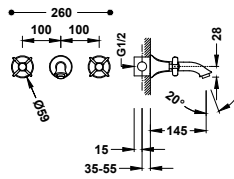

Grifo bimando empotrado para lavabo

Cuerpo empotrado incluido e indivisible. Con volantes. Caño de 145 mm.

■ 24215102

- 24215102AC
- 24215102OR
- 24215102LV
- 24215102LM

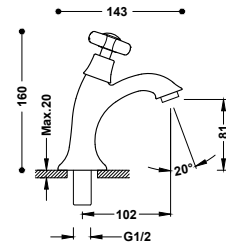

Grifo de 1 agua para lavabo

Con conexión roscada de G1/2.

■ 24250301

- 24250301AC
- 24250301OR
- 24250301LV
- 24250301LM

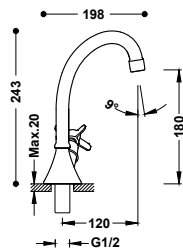

Grifo de 1 agua con volante lateral para lavabo

Con conexión roscada de G1/2.

■ 24230601

- 24230601AC
- 24230601OR
- 24230601LV
- 24230601LM

GRIFOS PARA BIDÉ

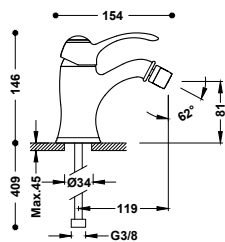

Grifo monomando para bidé

Rótula orientable. Latiguillos de alimentación flexibles G3/8.



- 24212001
- 24212001AC
- 24212001OR
- 24212001LV
- 24212001LM

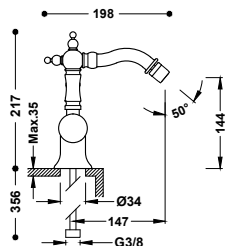

Grifo monomando con maneta lateral para bidé

Rótula orientable. Latiguillos de alimentación flexibles G3/8.



- 24222001
- 24222001AC
- 24222001OR
- 24222001LV
- 24222001LM

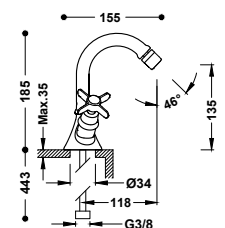

Grifo bimando para bidé

Rótula orientable. Con volantes. Latiguillos de alimentación flexibles G3/8.



- 24212201
- 24212201AC
- 24212201OR
- 24212201LV
- 24212201LM

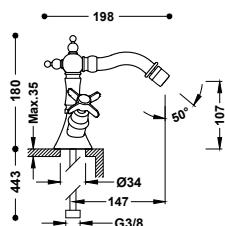

Grifo bimando para bidé

Rótula orientable. Con volantes. Latiguillos de alimentación flexibles G3/8.



- 24212202
- 24212202AC
- 24212202OR
- 24212202LV
- 24212202LM

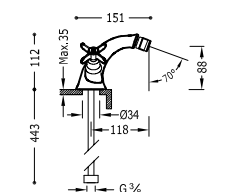

Grifo bimando para bidé

Rótula orientable. Con volantes. Latiguillos de alimentación flexibles G3/8.



- 24212101
- 24212101AC
- 24212101OR
- 24212101LV
- 24212101LM



GRIFOS MURALES

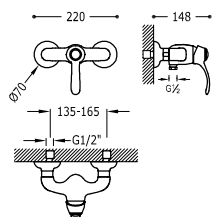

Grifo monomando mural para ducha

Ducha de mano anticalcárea de latón: Ø 78 mm. Soporte orientable para ducha de mano. Flexo metálico reforzado.

- 24216701
- 24216701AC
- 24216701OR
- 24216701LV
- 24216701LM

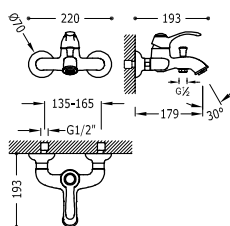

Grifo monomando mural para bañera y ducha

Ducha de mano anticalcárea de latón: Ø 78 mm. Soporte orientable para ducha de mano. Flexo metálico reforzado.

- 24217001
- 24217001AC
- 24217001OR
- 24217001LV
- 24217001LM

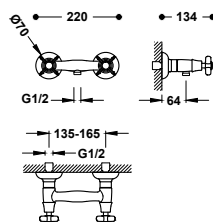
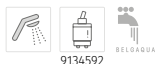

Grifo bimando mural para ducha

Ducha de mano anticalcárea de latón: Ø 78 mm. Soporte orientable para ducha de mano. Flexo metálico reforzado.

- 24216301
- 24216301AC
- 24216301OR
- 24216301LV
- 24216301LM

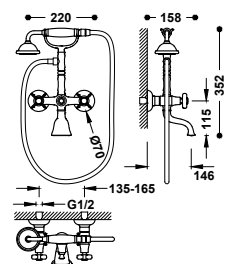
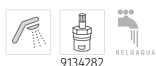

Grifo bimando mural para bañera y ducha

Ducha de mano anticalcárea de latón: Ø 78 mm. Soporte fijo para ducha de mano. Flexo metálico reforzado.

- 24217601
- 24217601AC
- 24217601OR
- 24217601LV
- 24217601LM

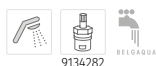

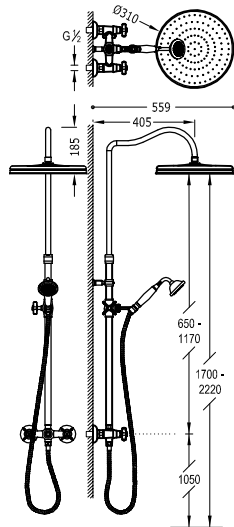
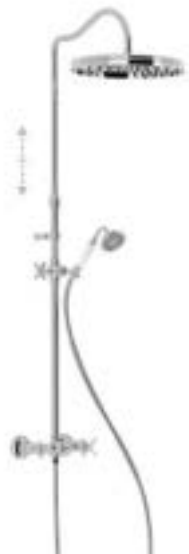

Conjunto de grifo bimando mural de 2 vías para ducha

- Barra de ducha telescópica.
- Rociador de ducha orientable de latón: Ø 310 mm.
- Soporte deslizante y orientable para ducha de mano.
- Ducha de mano anticalcárea de latón: Ø 78 mm.
- Flexo metálico reforzado.

- 24219101
- 24219101AC
- 24219101LV
- 24219101LM

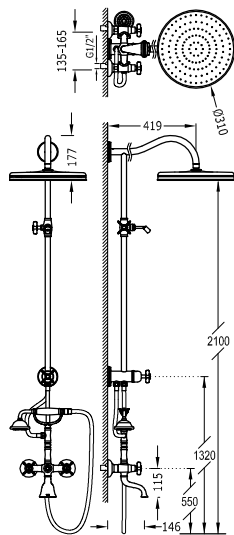

Conjunto de grifo bimando mural de 2 vías para bañera y ducha

- Con inversor integrado en la barra de ducha.
- Rociador de ducha orientable de latón: Ø 310 mm.
- Soporte deslizante y orientable para ducha de mano.
- Ducha de mano anticalcárea de latón: Ø 78 mm.
- Flexo metálico reforzado.

- 24217602
- 24217602AC
- 24217602LV
- 24217602LM



COMPLEMENTOS DE DUCHA

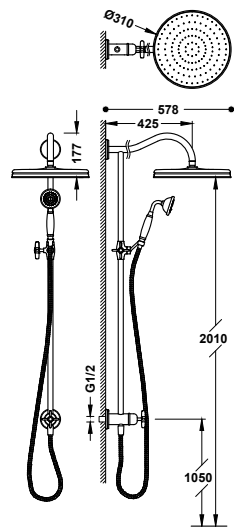
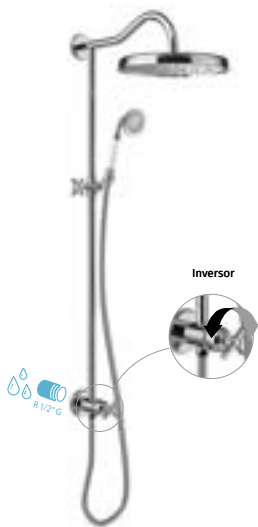

Conjunto de barra de ducha sin grifo con toma de agua a pared y rociador

- Con inversor integrado en la barra de ducha.
- Rociador de ducha orientable de latón: Ø 310 mm.
- Soporte deslizante y orientable para ducha de mano.
- Ducha de mano anticalcárea de latón: Ø 78 mm.
- Flexo metálico reforzado.

- 24247602
- 24247602AC
- 24247602LV
- 24247602LM



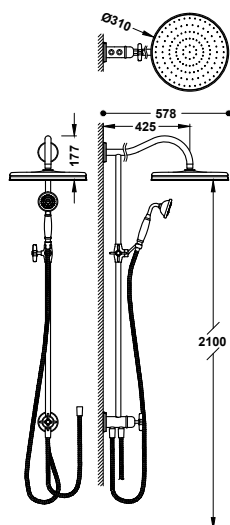

Conjunto de barra de ducha adaptable a cualquier grifo

- Con inversor integrado en la barra de ducha.
- Rociador de ducha orientable de latón: Ø 310 mm.
- Soporte deslizante y orientable para ducha de mano.
- Ducha de mano anticálcarea de latón: Ø 78 mm.
- Flexo metálico reforzado.

- 24247601
- 24247601AC
- 24247601LV
- 24247601LM

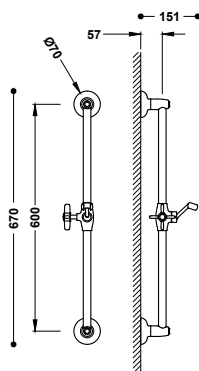

Barra deslizante para ducha

Barra de ducha: long. 600 mm y Ø 20,6 mm. Soporte deslizante y orientable para ducha de mano.

- 24273201
- 24273201AC
- 24273201LV
- 24273201LM

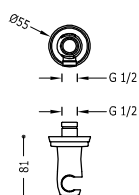

Soporte fijo con toma de agua para ducha de mano y flexo

Con toma de agua a pared.

- 24218201
- 24218201AC
- 24218201OR
- 24218201LV
- 24218201LM

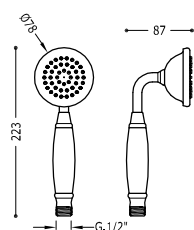

Ducha de mano

Mango cerámico. Dimensiones: Ø 78 mm. Material: Latón. Boquillas anticálcarea.

- 29963109
- 29963109AC
- 29963109OR
- 29963109LV
- 29963109LM

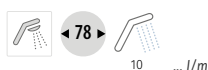

GRIFOS EMPOTRADOS

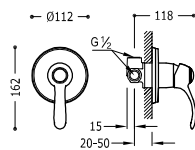

Grifo monomando empotrado de 1 vía para ducha
Cuerpo empotrado incluido.

- 24217701
- 24217701AC
- 24217701OR
- 24217701LV
- 24217701LM

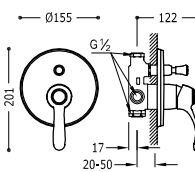

Grifo monomando empotrado de 2 vías para bañera y ducha
Cuerpo empotrado incluido. Inversor de 2 vías.

- 24218001
- 24218001AC
- 24218001OR
- 24218001LV
- 24218001LM

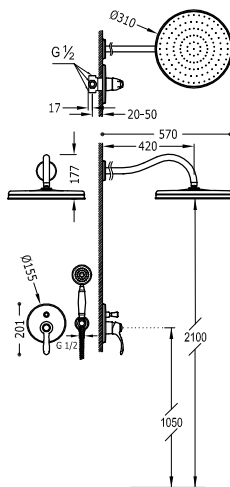
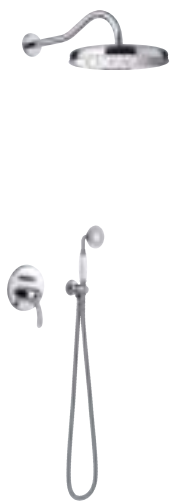

Kit de grifo monomando empotrado de 2 vías para ducha

- Cuerpo empotrado incluido.
- Inversor de 2 vías.
- Brazo a pared con rociador de ducha orientable y de latón: Ø 310 mm.
- Soporte para ducha de mano con toma de agua a pared.
- Ducha de mano anticalcárea de latón: Ø 78 mm.
- Flexo metálico reforzado.

- 24218003
- 24218003AC
- 24218003OR
- 24218003LV
- 24218003LM

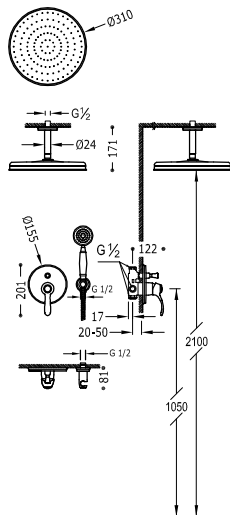

Kit de grifo monomando empotrado de 2 vías para ducha

- Cuerpo empotrado incluido.
- Inversor de 2 vías.
- Brazo a techo con rociador de ducha orientable y de latón: Ø 310 mm.
- Soporte para ducha de mano con toma de agua a pared.
- Ducha de mano anticalcárea de latón: Ø 78 mm.
- Flexo metálico reforzado.

- 24218004
- 24218004AC
- 24218004OR
- 24218004LV
- 24218004LM



GRIFOS PARA BAÑERA

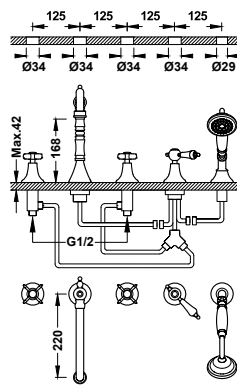

Grifo bimando para borde de bañera

- Con volantes e inversor.
- Ducha de mano anticalcárea de latón: Ø 78 mm.
- Caudal: 3 bar - 12 l/min.

24214601

- 24214601AC
- 24214601OR
- 24214601LV
- 24214601LM



9134282

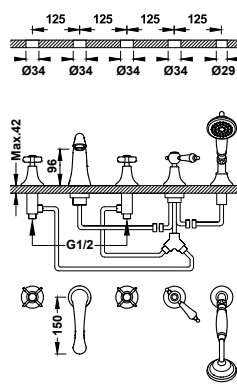

Grifo bimando para borde de bañera

- Con volantes e inversor.
- Ducha de mano anticalcárea de latón: Ø 78 mm.
- Caudal: 3 bar - 12 l/min.

24214602

- 24214602AC
- 24214602OR
- 24214602LV
- 24214602LM



9134282

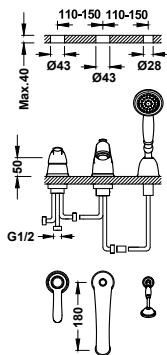

Grifo monomando para borde de bañera

- Inversor integrado en el caño de bañera.
- Ducha de mano anticalcárea de latón: Ø 78 mm.
- Caño de bañera de 180 mm. Caudal: 3 bar - 16 l/min.

24214501

- 24214501AC
- 24214501OR
- 24214501LV
- 24214501LM



9134591

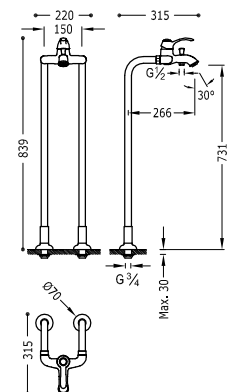

Grifo monomando a suelo para bañera y ducha

- Con 2 columnas verticales de alimentación de agua a suelo. Ducha de mano anticalcárea de latón: Ø 78 mm. Soporte fijo para ducha de mano. Flexo metálico reforzado.

24219402

- 24219402AC
- 24219402LV
- 24219402LM



9134592

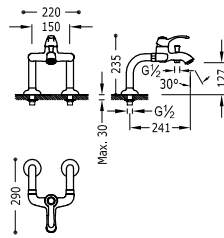

Grifo monomando para borde de bañera con tomas de agua acodadas

Con 2 tomas de agua acodadas. Ducha de mano anticalcárea de latón: Ø 78 mm. Soporte fijo para ducha de mano. Flexo metálico reforzado.

- 24219401
- 24219401AC
- 24219401OR
- 24219401LV
- 24219401LM



GRIFOS TERMOSTÁTICOS MURALES

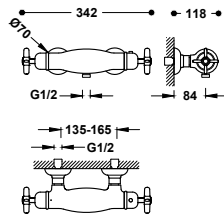

Grifo termostático mural para ducha

Ducha de mano anticalcárea de latón: Ø 78 mm. Soporte orientable para ducha de mano. Flexo metálico reforzado.

- 24216409
- 24216409AC
- 24216409OR
- 24216409LV
- 24216409LM

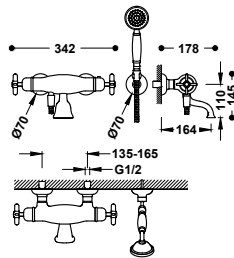

Grifo termostático mural para bañera y ducha

Con salida del agua en cascada. Inversor integrado en el regulador de caudal. Ducha de mano anticalcárea de latón: Ø 78 mm. Soporte orientable para ducha de mano. Flexo metálico reforzado.

- 24217409
- 24217409AC
- 24217409OR
- 24217409LV
- 24217409LM

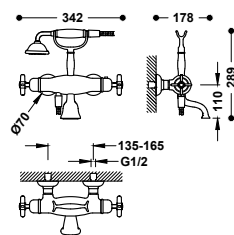

Grifo termostático mural para bañera y ducha

Con salida del agua en cascada. Inversor integrado en el regulador de caudal. Ducha de mano anticalcárea de latón: Ø 78 mm. Soporte fijo para ducha de mano. Flexo metálico reforzado.

- 24217609
- 24217609AC
- 24217609OR
- 24217609LV
- 24217609LM



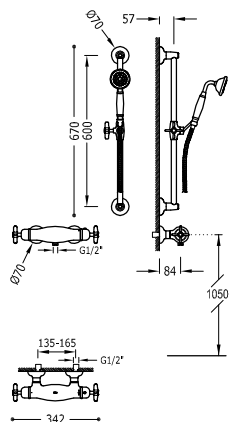

Kit de grifo termostático mural para ducha

- Barra de ducha: long. 600 mm.
- Soporte deslizante y orientable para ducha de mano.
- Ducha de mano anticalcárea de latón: Ø 78 mm.
- Flexo metálico reforzado.

- 24216402
- 24216402AC
- 24216402LV
- 24216402LM

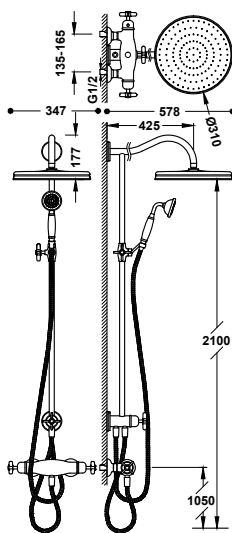

Conjunto de grifo termostático mural de 1 vía para ducha

- Con inversor integrado en la barra de ducha.
- Rociador de ducha orientable de latón: Ø 310 mm.
- Soporte deslizante y orientable para ducha de mano.
- Ducha de mano anticalcárea de latón: Ø 78 mm.
- Flexo metálico reforzado.

- 24219501
- 24219501AC
- 24219501LV
- 24219501LM

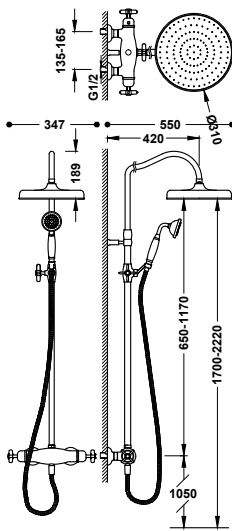

Conjunto de grifo termostático mural de 2 vías para ducha

- Con inversor integrado en el regulador de caudal.
- Barra de ducha telescópica.
- Rociador de ducha orientable de latón: Ø 310 mm.
- Soporte deslizante y orientable para ducha de mano.
- Ducha de mano anticalcárea de latón: Ø 78 mm.
- Flexo metálico reforzado.

- 24219502
- 24219502AC
- 24219502LV
- 24219502LM



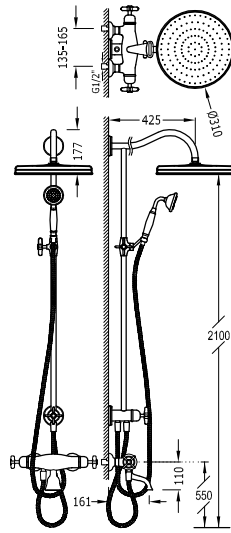

Conjunto de grifo termostático mural de 2 vías para bañera y ducha

- Con inversor integrado en el regulador de caudal y en la barra de ducha.
- Salida del agua en cascada.
- Rociador de ducha orientable de latón: Ø 310 mm.
- Soporte deslizante y orientable para ducha de mano.
- Ducha de mano anticalcárea de latón: Ø 78 mm.
- Flexo metálico reforzado.

■ 24219801

■ 24219801AC

■ 24219801LV

■ 24219801LM

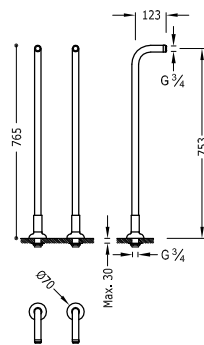

Tomas de agua acodadas de instalación a suelo para grifo de bañera

2 columnas verticales de alimentación de agua a suelo.

■ 24219403

■ 24219403AC

■ 24219403LV

■ 24219403LM

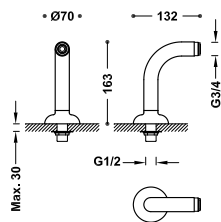

Tomas de agua acodadas de instalación a borde bañera para grifo de bañera

2 unidades con silenciador.

■ 24287101

■ 24287101AC

■ 24287101OR

■ 24287101LV

■ 24287101LM

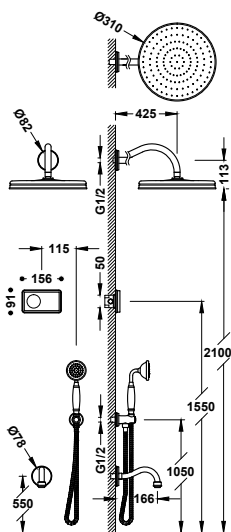

**Kit de grifo termostático electrónico empotrado de 3 vías
Shower Technology Blue Edition para bañera y ducha**

- Control electrónico blanco incluido con juntas antihumedad Schlüter.
- Centralita termostática electrónica incluida de 3 vías.
- Brazo a pared con rociador de ducha orientable de latón: Ø 310 mm.
- Caño fijo de bañera a pared.
- Soporte para ducha de mano con toma de agua a pared.
- Ducha de mano anticalcárea de latón: Ø 78 mm.
- Flexo metálico reforzado.

09226301

09226301AC

09226301OR

09226301LV

09226301LM

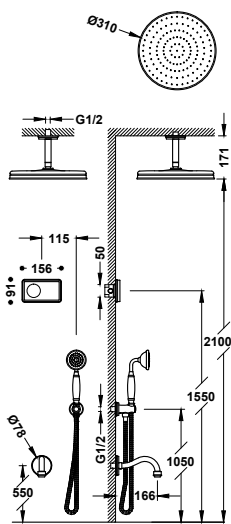

**Kit de grifo termostático electrónico empotrado de 3 vías
Shower Technology Blue Edition para bañera y ducha**

- Control electrónico blanco incluido con juntas antihumedad Schlüter.
- Centralita termostática electrónica incluida de 3 vías.
- Brazo a techo con rociador de ducha orientable de latón: Ø 310 mm.
- Caño fijo de bañera a pared.
- Soporte para ducha de mano con toma de agua a pared.
- Ducha de mano anticalcárea de latón: Ø 78 mm.
- Flexo metálico reforzado.

09226302

09226302AC

09226302OR

09226302LV

09226302LM





GRIFOS PARA VARIOS USOS

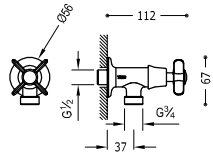

Grifo empotrado de 1 agua para lavadora
Con conexión roscada de G1/2.

■ 24250001

- 24250001AC
- 24250001OR
- 24250001LV
- 24250001LM

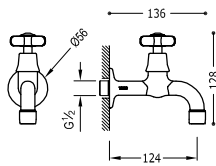

Grifo empotrado de 1 agua para office o lavadero
Con conexión roscada de G1/2.

■ 24252001

- 24252001AC
- 24252001OR
- 24252001LV
- 24252001LM



LLAVES DE PASO

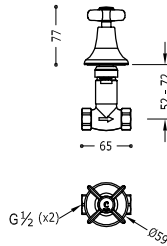

Llave de paso empotrada
Con conexión roscada de G1/2. Índice cerámico (frío).

■ 24215501

- 24215501AC
- 24215501OR
- 24215501LV
- 24215501LM

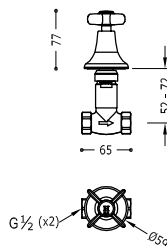

Llave de paso empotrada
Con conexión roscada de G1/2. Índice cerámico (caliente).

■ 24215502

- 24215502AC
- 24215502OR
- 24215502LV
- 24215502LM



SLIM

Líneas estilizadas y esbeltas para una exclusividad incomparable. La finura de las piezas de la serie Slim y la elegancia de sus acabados subrayan su longitud y enfatizan un estilo único, personal y contemporáneo.

Acabados disponibles:



CR

NM

BM

AC

OR

OM







GRIFOS PARA LAVABO

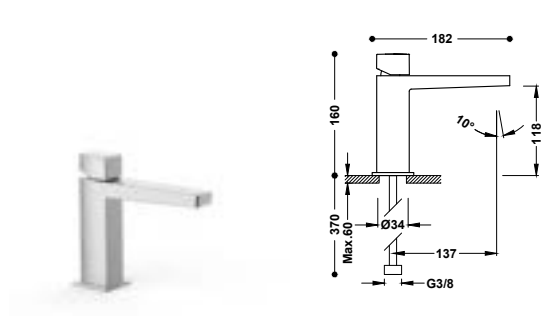

Grifo monomando para lavabo
Latiguillos de alimentación flexibles G3/8.

-  20210302
-  20210302D

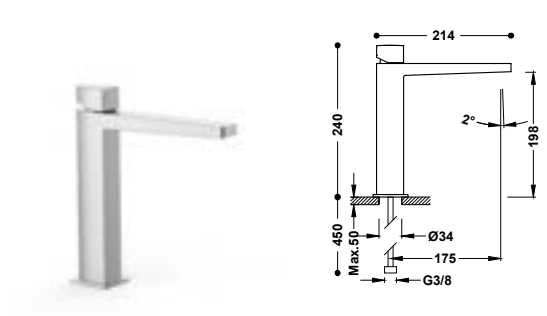

Grifo monomando alto para lavabo
Latiguillos de alimentación flexibles G3/8.

-  20210304

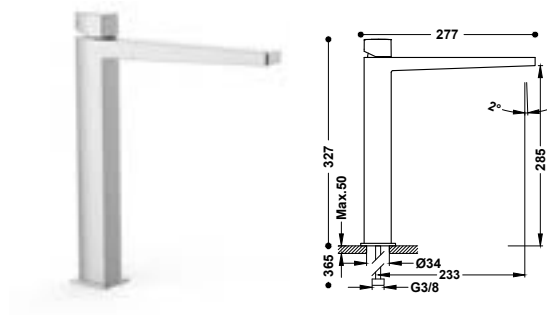

Grifo monomando XXL para lavabo
Latiguillos de alimentación flexibles G3/8.

-  20210306

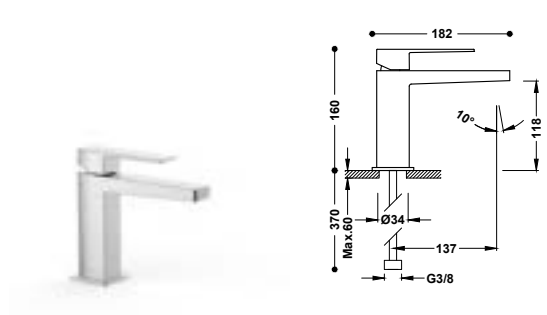





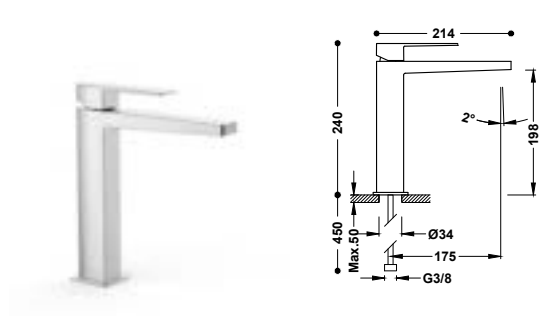

Grifo monomando para lavabo
Latiguillos de alimentación flexibles G3/8.

-  20210301
-  20210301D
-  20210301NM
-  20210301BM
-  20210301AC
-  20210301OR
-  20210301OM



Grifo monomando alto para lavabo
Latiguillos de alimentación flexibles G3/8.

-  20210303
-  20210303NM
-  20210303BM
-  20210303AC
-  20210303OR
-  20210303OM



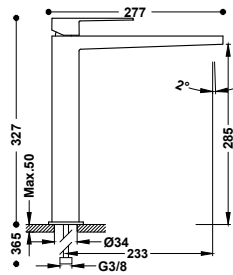

Grifo monomando XXL para lavabo
Latiguillos de alimentación flexibles G3/8.



- 20210305
- 20210305NM
- 20210305BM
- 20210305AC
- 20210305OR
- 20210305OM

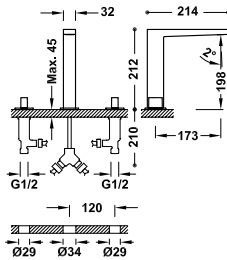

Grifo bimando de repisa para lavabo
De instalación libre. Con volantes.



- 20210501
- 20210501NM
- 20210501BM
- 20210501AC
- 20210501OR
- 20210501OM

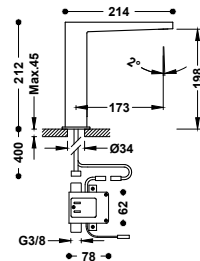

Grifo electrónico de 1 agua para lavabo
Accionado mediante sensor de infrarrojos.



- 20261310
- 20261310NM
- 20261310BM
- 20261310AC
- 20261310OR
- 20261310OM

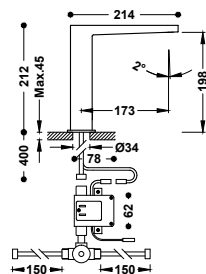

Grifo electrónico con sistema premezclador para lavabo
Accionado mediante sensor de infrarrojos. Incluye una válvula mezcladora de 2 aguas con tubos flexibles (ref. 19250730).



- 20261320
- 20261320NM
- 20261320BM
- 20261320AC
- 20261320OR
- 20261320OM

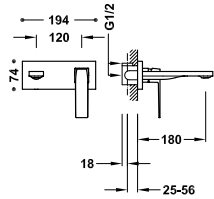

Grifo monomando empotrado para lavabo

Cuerpo empotrado indivisible con amortiguadores acústicos. Junta antihumedad. Caño de 180 mm.



29902801

-  20230011
-  20230011NM
-  20230011BM
-  20230011AC
-  20230011OR
-  20230011OM

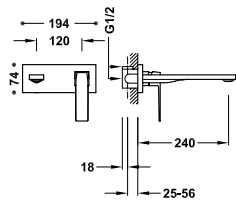







Grifo monomando empotrado para lavabo

Cuerpo empotrado indivisible con amortiguadores acústicos. Junta antihumedad. Caño de 240 mm.



29902801

-  20230012
-  20230012NM
-  20230012BM
-  20230012AC
-  20230012OR
-  20230012OM

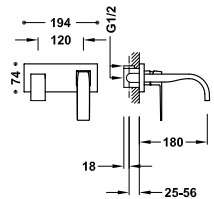







Grifo monomando empotrado para lavabo

Cuerpo empotrado indivisible con amortiguadores acústicos. Junta antihumedad. Caño de 180 mm.



29902801

-  20230013
-  20230013NM
-  20230013BM
-  20230013AC
-  20230013OR
-  20230013OM

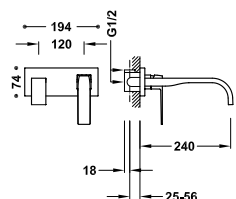







Grifo monomando empotrado para lavabo

Cuerpo empotrado indivisible con amortiguadores acústicos. Junta antihumedad. Caño de 240 mm.



29902801

-  20230014
-  20230014NM
-  20230014BM
-  20230014AC
-  20230014OR
-  20230014OM

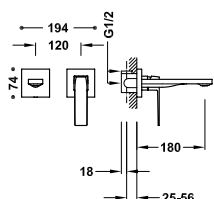

Grifo monomando empotrado para lavabo

Cuerpo empotrado indivisible con amortiguadores acústicos. Junta antihumedad. Caño de 180 mm.



29902801



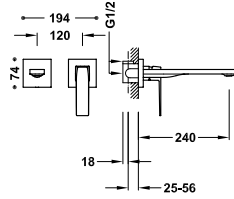



-  20230001
-  20230001NM
-  20230001BM
-  20230001AC
-  20230001OR
-  20230001OM



Grifo monomando empotrado para lavabo

Cuerpo empotrado indivisible con amortiguadores acústicos. Junta antihumedad. Caño de 240 mm.





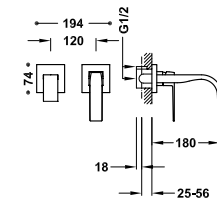



-  20230002
-  20230002NM
-  20230002BM
-  20230002AC
-  20230002OR
-  20230002OM



Grifo monomando empotrado para lavabo





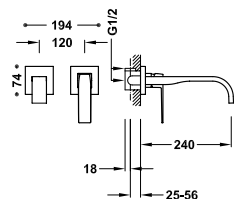

Cuerpo empotrado indivisible con amortiguadores acústicos. Junta antihumedad. Caño de 180 mm.

-  20230003
-  20230003NM
-  20230003BM
-  20230003AC
-  20230003OR
-  20230003OM



Grifo monomando empotrado para lavabo

Cuerpo empotrado indivisible con amortiguadores acústicos. Junta antihumedad. Caño de 240 mm.

-  20230004
-  20230004NM
-  20230004BM
-  20230004AC
-  20230004OR
-  20230004OM

GRIFOS PARA BIDÉ

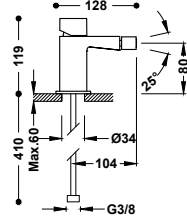

Grifo monomando para bidé





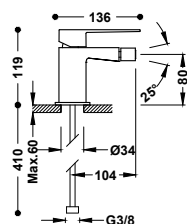

Rótula orientable. Latiguillos de alimentación flexibles G3/8.

-  20212002
-  20212002D



Grifo monomando para bidé

Rótula orientable. Latiguillos de alimentación flexibles G3/8.

-  20212001
-  20212001D
-  20212001NM
-  20212001BM
-  20212001AC
-  20212001OR
-  20212001OM

GRIFOS MURALES

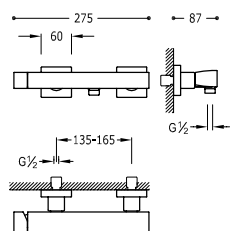

Grifo monomando mural para ducha

Ducha de mano anticalcárea de latón. Soporte orientable para ducha de mano. Flexo satinado.

20216701

- 20216701NM
- 20216701BM
- 20216701AC
- 20216701OR
- 20216701OM

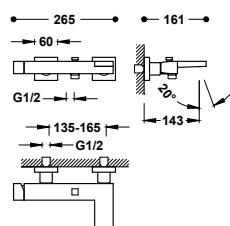

Grifo monomando mural para bañera y ducha

Ducha de mano anticalcárea de latón. Soporte orientable para ducha de mano. Flexo satinado.

20217001

- 20217001NM
- 20217001BM
- 20217001AC
- 20217001OR
- 20217001OM

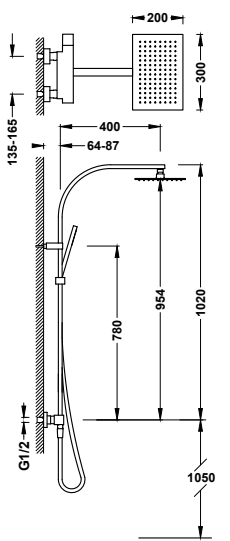

Conjunto de grifo monomando mural de 2 vías para ducha

- Rociador de ducha orientable de acero inoxidable: 300x200 mm.
- Soporte deslizante y orientable para ducha de mano.
- Ducha de mano anticalcárea de latón.
- Flexo satinado.

20219101





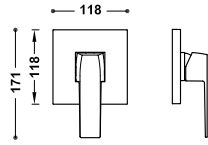

- 20219101NM
- 20219101BM
- 20219101AC



GRIFOS EMPOTRADOS RAPID-BOX



Pieza vista para caja empotrada de 1 vía Rapid-box
 Sólo parte vista. Incluye placa embellecedora, mando, casquillo y tornillo de fijación oculto. **Caja empotrada no incluida.**

-  20227810
-  20227810NM
-  20227810BM
-  20227810AC
-  20227810OR
-  20227810OM





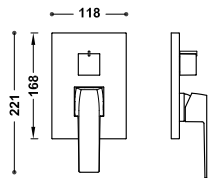

Caja empotrada de 1 vía Rapid-box con grifo monomando para ducha

20827810



Pieza vista para caja empotrada de 2 vías Rapid-box
 Sólo parte vista. Incluye placa embellecedora, mando, volante distribuidor y tornillo de fijación oculto. **Caja empotrada no incluida.**

-  20228110
-  20228110NM
-  20228110BM
-  20228110AC
-  20228110OR
-  20228110OM







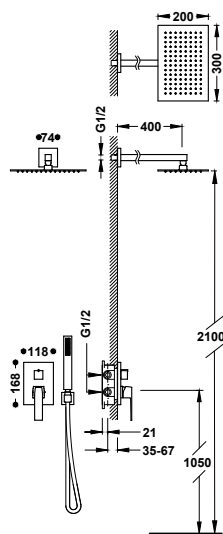

Caja empotrada de 2 vías Rapid-box con grifo monomando para ducha y bañera

20828110



Kit de grifo monomando empotrado de 2 vías Rapid-box para ducha

- Cuerpo empotrado incluido.
- Distribuidor cerámico de 2 vías.
- Brazo a pared con rociador de ducha orientable y de acero inoxidable: 300x200 mm.
- Soporte para ducha de mano con toma de agua a pared.
- Ducha de mano anticalcárea de latón.
- Flexo satinado.

-  20228004
-  20228004NM
-  20228004BM
-  20228004AC
-  20228004OR
-  20228004OM



29903508

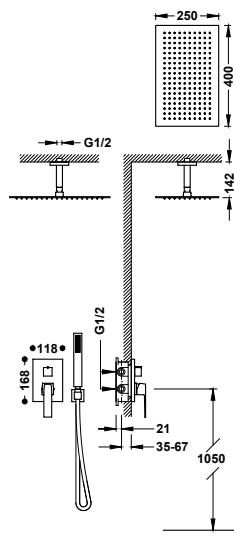

Kit de grifo monomando empotrado de 2 vías Rapid-box para ducha

- Cuerpo empotrado incluido.
- Distribuidor cerámico de 2 vías.
- Brazo a techo con rociador de ducha orientable y de acero inoxidable: 400x250 mm.
- Soporte para ducha de mano con toma de agua a pared.
- Ducha de mano anticalcárea de latón.
- Flexo satinado.

- 20228003
- 20228003NM
- 20228003BM
- 20228003AC
- 20228003OR
- 20228003OM

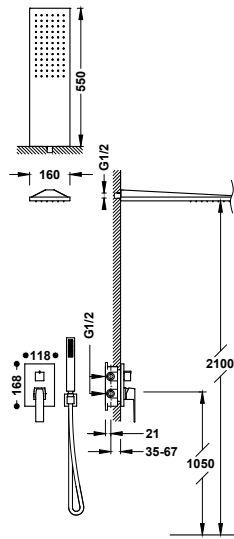

Kit de grifo monomando empotrado de 2 vías Rapid-box para ducha

- Cuerpo empotrado incluido.
- Distribuidor cerámico de 2 vías.
- Rociador de ducha a pared de acero inoxidable: 160x550 mm.
- Soporte para ducha de mano con toma de agua a pared.
- Ducha de mano anticalcárea de latón.
- Flexo satinado.

- 20228005
- 20228005NM
- 20228005BM
- 20228005AC
- 20228005OR
- 20228005OM

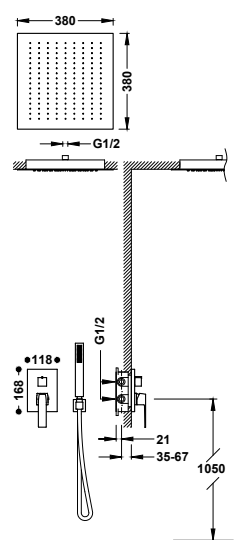

Kit de grifo monomando empotrado de 2 vías Rapid-box para ducha

- Cuerpo empotrado incluido.
- Distribuidor cerámico de 2 vías.
- Rociador de ducha empotrado a techo de acero inoxidable: 380x380 mm.
- Soporte para ducha de mano con toma de agua a pared.
- Ducha de mano anticalcárea de latón.
- Flexo satinado.

- 20228006
- 20228006NM
- 20228006BM
- 20228006AC
- 20228006OR
- 20228006OM



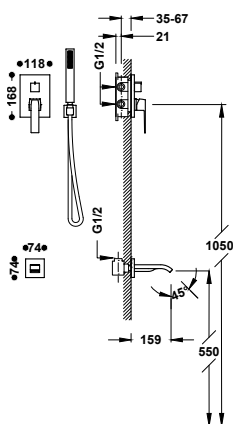

Kit de grifo monomando empotrado de 2 vías Rapid-box para bañera y ducha

- Cuerpo empotrado incluido.
- Distribuidor cerámico de 2 vías.
- Caño fijo de bañera a pared.
- Soporte para ducha de mano con toma de agua a pared.
- Ducha de mano anticalcárea de latón.
- Flexo satinado.

- 20228007
- 20228007NM
- 20228007BM
- 20228007AC
- 20228007OR
- 20228007OM



GRIFOS PARA BAÑERA

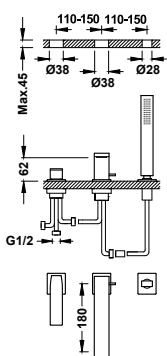

Grifo monomando para borde de bañera

- Inversor integrado en el caño de bañera.
- Ducha de mano anticalcárea de latón.
- Caño de bañera de 180 mm. Caudal: 3 bar - 13 l/m.
- Kit depósito opcional no incluido ref: 20224501.

- 20216103
- 20216103NM
- 20216103BM
- 20216103AC
- 20216103OR
- 20216103OM



Depósito para grifería de borde de bañera

- 20224501

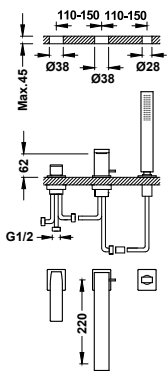

Grifo monomando para borde de bañera

- Inversor integrado en el caño de bañera.
- Ducha de mano anticalcárea de latón.
- Caño de bañera de 220 mm. Caudal: 3 bar - 13 l/m.
- Kit depósito opcional no incluido ref: 20224501.

- 20216101
- 20216101NM
- 20216101BM
- 20216101AC
- 20216101OR
- 20216101OM



Depósito para grifería de borde de bañera

- 20224501

GRIFOS TERMOSTÁTICOS MURALES

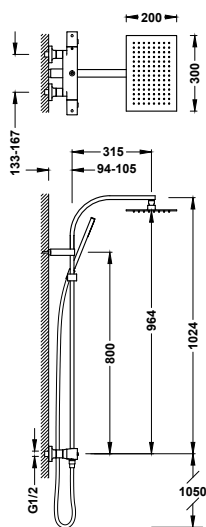

Conjunto de grifo termostático mural Over-wall de 2 vías para ducha

- Con inversor integrado en el regulador de caudal.
- Volante cuadrado.
- Rociador de ducha orientable de acero inoxidable: 300x200 mm.
- Soporte deslizante y orientable para ducha de mano.
- Ducha de mano anticalcárea de latón.
- Flexo satinado.

- 19039306
- 19039306NM
- 19039306BM
- 19039306AC
- 19039306OM



GRIFOS TERMOSTÁTICOS EMPOTRADOS

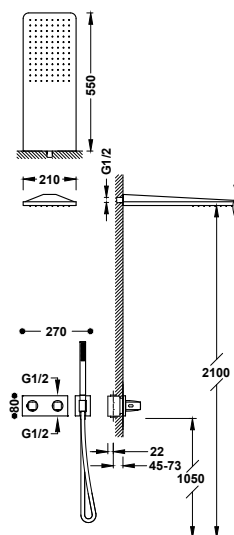

Kit de grifo termostático empotrado de 2 vías B-system para ducha

- Cuerpo empotrado termostático de instalación horizontal incluido.
- Regulador de caudal y distribuidor cerámico de 2 vías.
- Volante cuadrado-redondo.
- Rociador de ducha a pared de acero inoxidable: 210x550 mm.
- Soporte para ducha de mano con toma de agua a pared.
- Ducha de mano anticalcárea de latón.
- Flexo satinado.

- 30725205
- 30725205NM
- 30725205AC
- 30725205OR
- 30725205OM



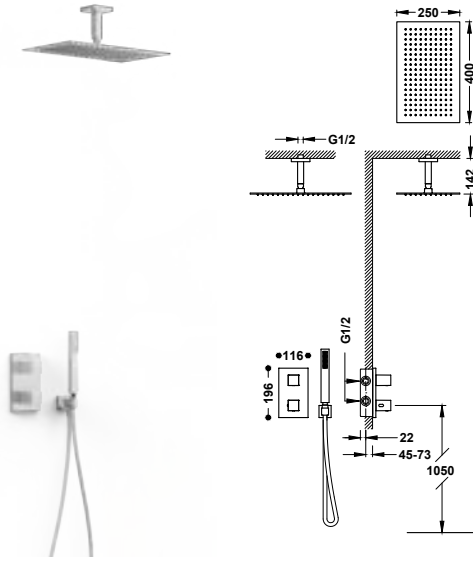

Kit de grifo termostático empotrado de 2 vías Therm-box para ducha

- Cuerpo empotrado incluido.
- Volante cuadrado con control de temperatura. Distribuidor cerámico de 2 vías.
- Brazo a techo con rociador de ducha orientable y de acero inoxidable: 400x250 mm.
- Soporte para ducha de mano con toma de agua a pared.
- Ducha de mano anticalcárea de latón.
- Flexo satinado.

20225053

20225053NM

20225053BM

20225053AC

20225053OR

20225053OM

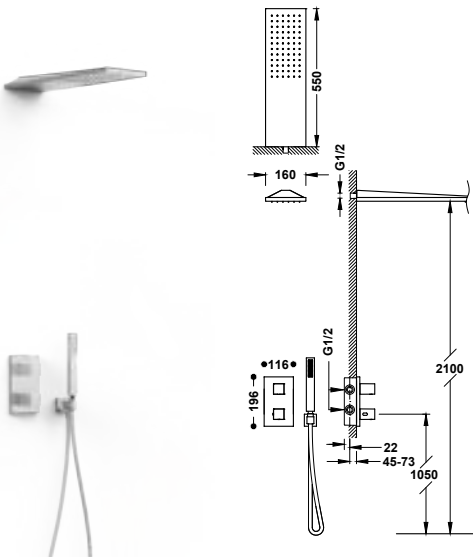

Kit de grifo termostático empotrado de 2 vías Therm-box para ducha

- Cuerpo empotrado incluido.
- Volante cuadrado con control de temperatura. Distribuidor cerámico de 2 vías.
- Rociador de ducha a pared de acero inoxidable: 160x550 mm.
- Soporte para ducha de mano con toma de agua a pared.
- Ducha de mano anticalcárea de latón.
- Flexo satinado.

20225055

20225055NM

20225055BM

20225055AC

20225055OR

20225055OM





STUDY

Simple a la vez que extravagante. Los cuerpos cilíndricos y delgados de Study aspiran al equilibrio atemporal. Un diseño minimalista y armonioso con acabados metálicos que sorprenden.

Acabados disponibles:

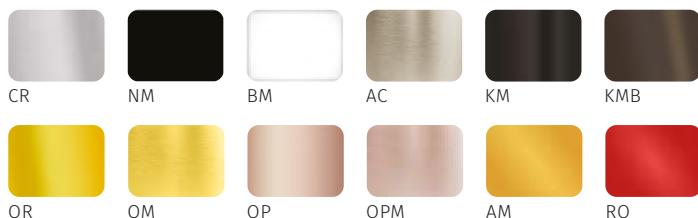

















GRIFOS PARA LAVABO

Grifo monomando para lavabo
Latiguillos de alimentación flexibles G3/8.

-  26190301
-  26190301D

-  26190301NM
-  26190301BM
-  26190301AC
-  26190301KM
-  26190301KMB
-  26190301OR
-  26190301OM
-  26190301OP
-  26190301OPM
-  26190301TAM
-  26190301TRO



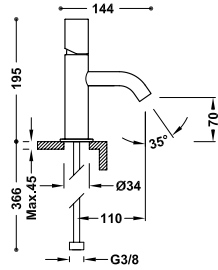







N



910719005

Grifo monomando alto para lavabo
Latiguillos de alimentación flexibles G3/8.

-  26130701

-  26130701NM
-  26130701BM
-  26130701AC
-  26130701KM
-  26130701KMB
-  26130701OR
-  26130701OM
-  26130701OP
-  26130701OPM
-  26130701TAM
-  26130701TRO



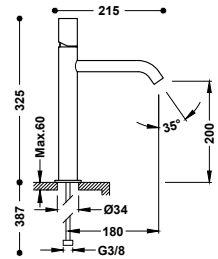







N



910719005

Grifo monomando XXL para lavabo
Latiguillos de alimentación flexibles G3/8.

-  26130801

-  26130801NM
-  26130801BM
-  26130801AC
-  26130801KM
-  26130801KMB
-  26130801OR
-  26130801OM
-  26130801OP
-  26130801OPM
-  26130801TAM
-  26130801TRO

N

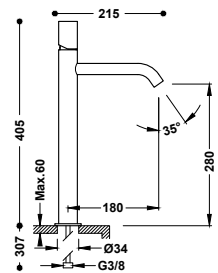

910719005

Grifo monomando para lavabo
 Latiguillos de alimentación flexibles G3/8.

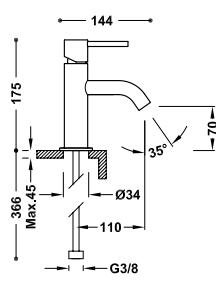
910719005

- 26290301
- 26290301D
- 26290301NM
- 26290301BM
- 26290301AC
- 26290301KM
- 26290301KMB
- 26290301OR
- 26290301OM
- 26290301OP
- 26290301OPM
- 26290301TAM
- 26290301TRO

Grifo monomando alto para lavabo
 Latiguillos de alimentación flexibles G3/8.

910719005

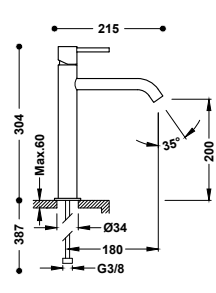
- 26230701
- 26230701NM
- 26230701BM
- 26230701AC
- 26230701KM
- 26230701KMB
- 26230701OR
- 26230701OM
- 26230701OP
- 26230701OPM
- 26230701TAM
- 26230701TRO

Grifo monomando XXL para lavabo
 Latiguillos de alimentación flexibles G3/8.

910719005

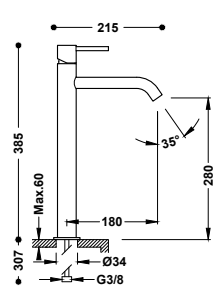
- 26230801
- 26230801NM
- 26230801BM
- 26230801AC
- 26230801KM
- 26230801KMB
- 26230801OR
- 26230801OM
- 26230801OP
- 26230801OPM
- 26230801TAM
- 26230801TRO



Grifo monomando con maneta lateral para lavabo
 Latiguillos de alimentación flexibles G3/8.

26290403

- 26290403NM
- 26290403BM
- 26290403AC
- 26290403KM
- 26290403KMB
- 26290403OR
- 26290403OM
- 26290403OP
- 26290403OPM
- 26290403TAM
- 26290403TRO

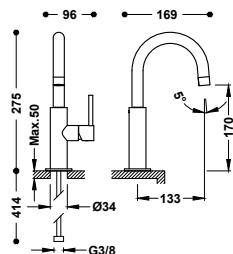

9130190

Grifo monomando alto con maneta lateral para lavabo
 Latiguillos de alimentación flexibles G3/8.

26290402

- 26290402NM
- 26290402BM
- 26290402AC
- 26290402KM
- 26290402KMB
- 26290402OR
- 26290402OM
- 26290402OP
- 26290402OPM
- 26290402TAM
- 26290402TRO

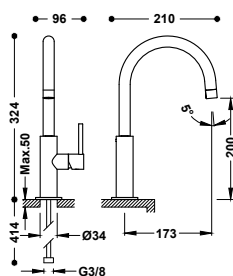

9130190

Grifo monomando XXL con maneta lateral para lavabo
 Latiguillos de alimentación flexibles G3/8.

26290401

- 26290401NM
- 26290401BM
- 26290401AC
- 26290401KM
- 26290401KMB
- 26290401OR
- 26290401OM
- 26290401OP
- 26290401OPM
- 26290401TAM
- 26290401TRO

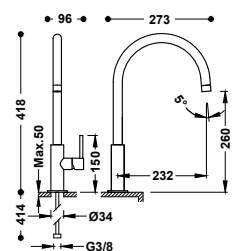

9130190

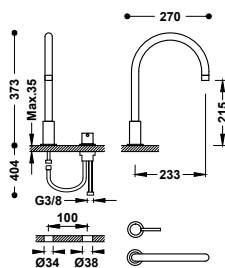

Grifo monomando de repisa para lavabo
De instalación libre.



- 26110501
- 26110501NM
- 26110501BM
- 26110501AC
- 26110501KM
- 26110501KMB
- 26110501OR
- 26110501OM
- 26110501OP
- 26110501OPM

N

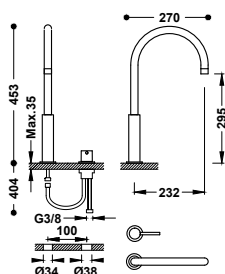

Grifo monomando alto de repisa para lavabo
De instalación libre.



- 26110502
- 26110502NM
- 26110502BM
- 26110502AC
- 26110502KM
- 26110502KMB
- 26110502OR
- 26110502OM
- 26110502OP
- 26110502OPM

N

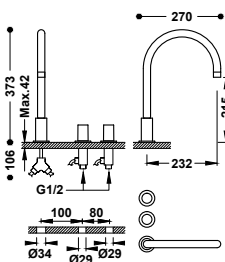

Grifo bimando de repisa para lavabo
De instalación libre. Con volantes.



- 06110501
- 06110501NM
- 06110501BM
- 06110501AC
- 06110501KM
- 06110501KMB
- 06110501OR
- 06110501OM
- 06110501OP
- 06110501OPM

N

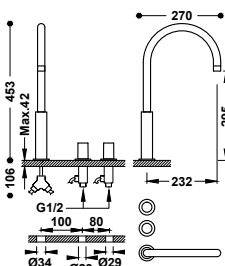

Grifo bimando alto de repisa para lavabo
De instalación libre. Con volantes.









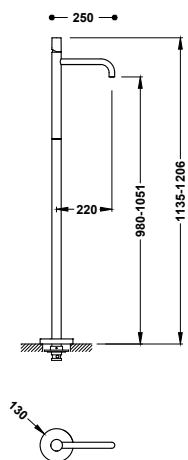



- 06110502
- 06110502NM
- 06110502BM
- 06110502AC
- 06110502KM
- 06110502KMB
- 06110502OR
- 06110502OM
- 06110502OP
- 06110502OPM

N





Grifo monomando con toma a suelo para lavabo
1 columna vertical de alimentación de agua a suelo. Caja empotrada no incluida.

-  26285306
-  26285306NM
-  26285306BM
-  26285306AC
-  26285306KM
-  26285306KMB
-  26285306OR
-  26285306OM
-  26285306OP
-  26285306OPM



910719005







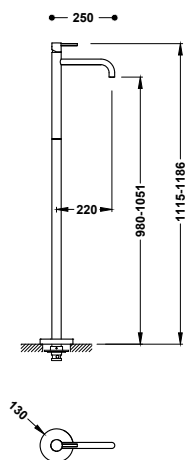





Base de empotramiento para montaje de grifos monomando a suelo

26285350



Grifo monomando con toma a suelo para lavabo
1 columna vertical de alimentación de agua a suelo. Caja empotrada no incluida.

-  26285305
-  26285305NM
-  26285305BM
-  26285305AC
-  26285305KM
-  26285305KMB
-  26285305OR
-  26285305OM
-  26285305OP
-  26285305OPM



910719005



Base de empotramiento para montaje de grifos monomando a suelo

26285350



Grifo monomando empotrado para lavabo

Cuerpo empotrado indivisible con amortiguadores acústicos. Junta antihumedad. Caño de 180 mm.

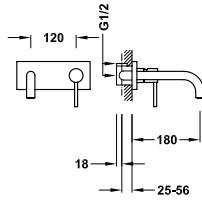

29902801

26230011

- 26230011NM
- 26230011BM
- 26230011AC
- 26230011KM
- 26230011KMB
- 26230011OR
- 26230011OM
- 26230011OP
- 26230011OPM

N

Grifo monomando empotrado para lavabo

Cuerpo empotrado indivisible con amortiguadores acústicos. Junta antihumedad. Caño de 240 mm.

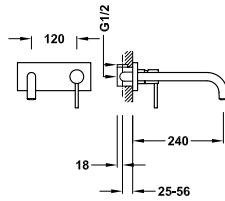

29902801

26230012

- 26230012NM
- 26230012BM
- 26230012AC
- 26230012KM
- 26230012KMB
- 26230012OR
- 26230012OM
- 26230012OP
- 26230012OPM

N

Grifo monomando empotrado para lavabo

Cuerpo empotrado indivisible con amortiguadores acústicos. Junta antihumedad. Caño de 177 mm.

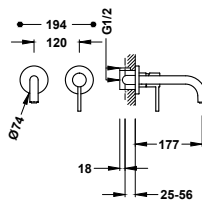

29902801

26230001

- 26230001NM
- 26230001BM
- 26230001AC
- 26230001KM
- 26230001KMB
- 26230001OR
- 26230001OM
- 26230001OP
- 26230001OPM

Grifo monomando empotrado para lavabo

Cuerpo empotrado indivisible con amortiguadores acústicos. Junta antihumedad. Caño de 237 mm.

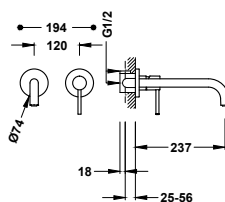

29902801

26230002

- 26230002NM
- 26230002BM
- 26230002AC
- 26230002KM
- 26230002KMB
- 26230002OR
- 26230002OM
- 26230002OP
- 26230002OPM











N

GRIFOS PARA BIDÉ

Grifo monomando para bidé

Rótula orientable. Latiguillos de alimentación flexibles G3/8.

-  26112001
-  26112001D

-  06112001NM
-  06112001BM
-  06112001AC
-  06112001KM
-  06112001KMB
-  06112001OR
-  06112001OM
-  06112001OP
-  06112001OPM
-  06112001TAM
-  06112001TRO

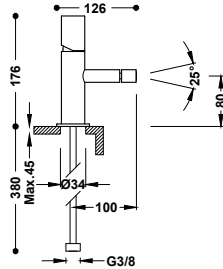











910719005

Grifo monomando para bidé

Rótula orientable. Latiguillos de alimentación flexibles G3/8.

-  26212001
-  26212001D

-  06212001NM
-  06212001BM
-  06212001AC
-  06212001KM
-  06212001KMB
-  06212001OR
-  06212001OM
-  06212001OP
-  06212001OPM
-  06212001TAM
-  06212001TRO

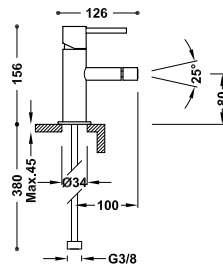











910719005

Grifo monomando con maneta lateral para bidé

Rótula orientable. Latiguillos de alimentación flexibles G3/8.

-  26222402

-  26222402NM
-  26222402BM
-  26222402AC
-  26222402KM
-  26222402KMB
-  26222402OR
-  26222402OM
-  26222402OP
-  26222402OPM
-  26222402TAM
-  26222402TRO

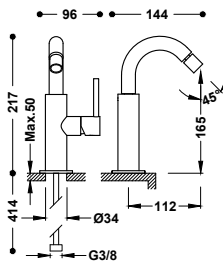

9130190

Grifo monomando empotrado con ducha para inodoro

Con agua fría o caliente. Ducha de mano con racor limitador a 5 l/min. y sistema antigoteo. Soporte fijo para la ducha de mano instalable a derecha o izquierda. Flexo satinado.

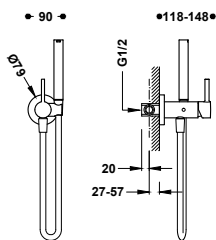

- 134123
- 134123NM
- 134123BM
- 134123AC
- 134123KM
- 134123KMB
- 134123OR
- 134123OM
- 134123OP
- 134123OPM

Grifo monomando empotrado con ducha para inodoro

Opción para paredes de Pladur. Con agua fría o caliente. Ducha de mano con racor limitador a 5 l/min. y sistema antigoteo. Soporte fijo para la ducha de mano instalable a derecha o izquierda. Flexo satinado.

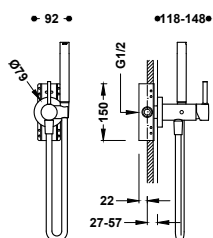

- 134122
- 134122NM
- 134122BM
- 134122AC

Accesorio porta toallas para grifo con ducha para inodoro

Soporte instalable a derecha o izquierda (para ref.: 134122, 134123, 181122, 181123, 181222, 181223, 20522201, 20522301). Long: 180 mm.



- 03412401
- 03412401NM
- 03412401BM
- 03412401AC
- 03412401KM
- 03412401KMB
- 03412401OR
- 03412401OM
- 03412401OP
- 03412401OPM



GRIFOS MURALES

Grifo monomando mural para ducha

Ducha de mano anticalcárea. Soporte orientable para ducha de mano. Flexo satinado.

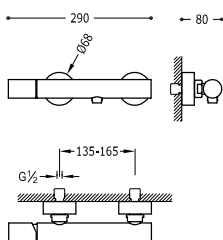

- 26116701
- 26116701NM
- 26116701BM
- 26116701AC
- 26116701KM
- 26116701KMB
- 26116701OR
- 26116701OM
- 26116701OP
- 26116701OPM
- 26116701TAM
- 26116701TRO

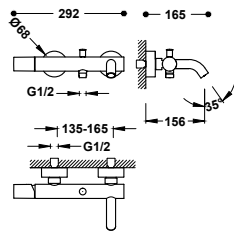

Grifo monomando mural para bañera y ducha

Ducha de mano anticalcárea. Soporte orientable para ducha de mano. Flexo satinado.



- 26117001
- 26117001NM
- 26117001BM
- 26117001AC
- 26117001KM
- 26117001KMB
- 26117001OR
- 26117001OM
- 26117001OP
- 26117001OPM
- 26117001TAM
- 26117001TRO

GRIFOS EMPOTRADOS RAPID-BOX

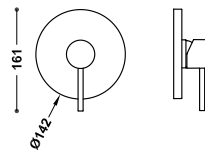

Pieza vista para caja empotrada de 1 vía Rapid-box

Sólo parte vista. Incluye placa embellecedora, mando, casquillo y tornillo de fijación oculto. **Caja empotrada no incluida.**



- 26227810
- 26227810NM
- 26227810BM
- 26227810AC
- 26227810KM
- 26227810KMB
- 26227810OR
- 26227810OM
- 26227810OP
- 26227810OPM



Caja empotrada de 1 vía Rapid-box con grifo monomando para ducha

20827810

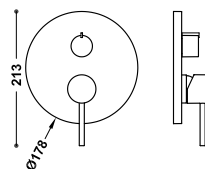

Pieza vista para caja empotrada de 2 vías Rapid-box

Sólo parte vista. Incluye placa embellecedora, mando, volante distribuidor y tornillo de fijación oculto. **Caja empotrada no incluida.**



- 26228110
- 26228110NM
- 26228110BM
- 26228110AC
- 26228110KM
- 26228110KMB
- 26228110OR
- 26228110OM
- 26228110OP
- 26228110OPM



Caja empotrada de 2 vías Rapid-box con grifo monomando para ducha y bañera

20828110



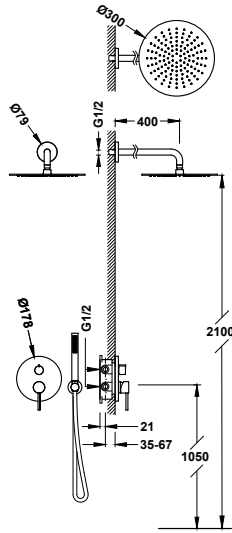

Kit de grifo monomando empotrado de 2 vías Rapid-box para ducha

- Cuerpo empotrado incluido.
- Distribuidor cerámico de 2 vías.
- Brazo a pared con rociador de ducha orientable y de acero inoxidable: Ø 300 mm.
- Soporte para ducha de mano con toma de agua a pared.
- Ducha de mano anticalcárea de latón.
- Flexo satinado.

26228004

- 26228004NM
- 26228004BM
- 26228004AC
- 26228004KM
- 26228004KMB
- 26228004OR
- 26228004OM
- 26228004OP
- 26228004OPM



29903508

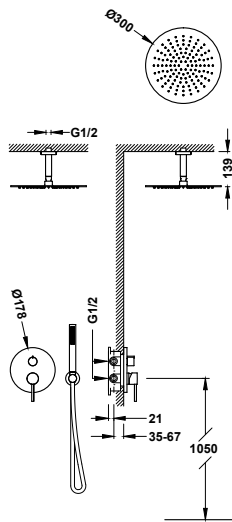

Kit de grifo monomando empotrado de 2 vías Rapid-box para ducha

- Cuerpo empotrado incluido.
- Distribuidor cerámico de 2 vías.
- Brazo a techo con rociador de ducha orientable y de acero inoxidable: Ø 300 mm.
- Soporte para ducha de mano con toma de agua a pared.
- Ducha de mano anticalcárea de latón.
- Flexo satinado.

26228003

- 26228003NM
- 26228003BM
- 26228003AC
- 26228003KM
- 26228003KMB
- 26228003OR
- 26228003OM
- 26228003OP
- 26228003OPM



29903508

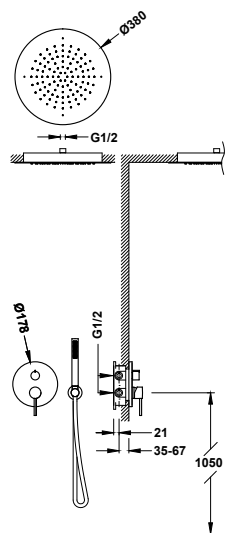

Kit de grifo monomando empotrado de 2 vías Rapid-box para ducha

- Cuerpo empotrado incluido.
- Distribuidor cerámico de 2 vías.
- Rociador de ducha empotrado a techo de acero inoxidable: Ø 380 mm.
- Soporte para ducha de mano con toma de agua a pared.
- Ducha de mano anticalcárea de latón.
- Flexo satinado.

26228005

- 26228005NM
- 26228005BM
- 26228005AC
- 26228005KM
- 26228005KMB
- 26228005OR
- 26228005OM
- 26228005OP
- 26228005OPM



29903508

N

N

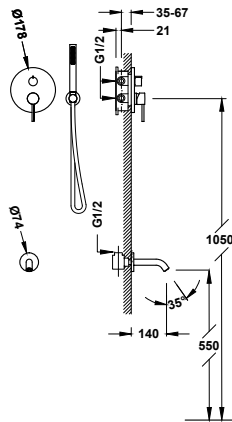

Kit de grifo monomando empotrado de 2 vías Rapid-box para bañera y ducha

- Cuerpo empotrado incluido.
- Distribuidor cerámico de 2 vías.
- Caño fijo de bañera a pared.
- Soporte para ducha de mano con toma de agua a pared.
- Ducha de mano anticalcárea de latón.
- Flexo satinado.

- 26228006
- 26228006NM
- 26228006BM
- 26228006AC
- 26228006KM
- 26228006KMB
- 26228006OR
- 26228006OM
- 26228006OP
- 26228006OPM



N

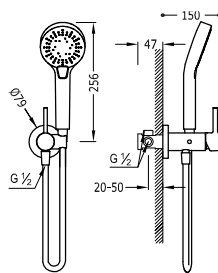

Grifo monomando empotrado de 1 vía para ducha

■ 26212301

- Cuerpo empotrado incluido.
- Ducha de mano anticalcárea: Ø 130 mm. (3 tipos de chorro).
- Soporte fijo para la ducha de mano instalable a derecha o izquierda.
- Flexo satinado.



GRIFOS PARA BAÑERA

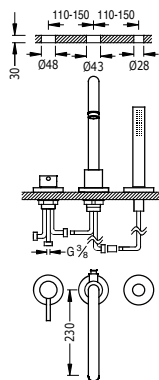

Grifo monomando para borde de bañera

■ 26215001

- Inversor integrado en el caño de bañera.
- Ducha de mano anticalcárea de latón.
- Caudal: 3 bar - 14 l/min.
- Kit depósito opcional no incluido ref.: 162245.



Depósito para grifería de borde de bañera

■ 162245

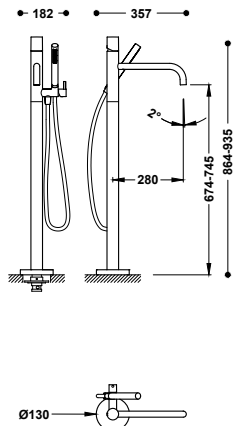

Grifo monomando a suelo para bañera y ducha

1 columna vertical de alimentación de agua a suelo. Soporte para ducha de mano con cierre y regulación de caudal independiente. Ducha de mano anticálcarea de latón. Flexo satinado. **Caja empotrada no incluida.**

26247006

- 26247006NM
- 26247006BM
- 26247006AC
- 26247006KM
- 26247006KMB
- 26247006OR
- 26247006OM
- 26247006OP
- 26247006OPM



Base de empotramiento para montaje de grifos monomando a suelo

26285350

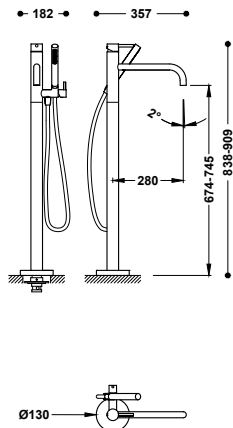

Grifo monomando a suelo para bañera y ducha

1 columna vertical de alimentación de agua a suelo. Soporte para ducha de mano con cierre y regulación de caudal independiente. Ducha de mano anticálcarea de latón. Flexo satinado. **Caja empotrada no incluida.**

26247005

- 26247005NM
- 26247005BM
- 26247005AC
- 26247005KM
- 26247005KMB
- 26247005OR
- 26247005OM
- 26247005OP
- 26247005OPM



Base de empotramiento para montaje de grifos monomando a suelo

26285350



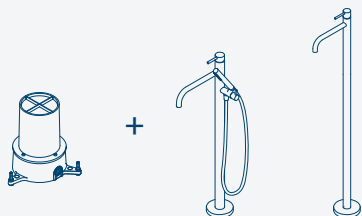

Compra e instala por separado

Puedes instalar la caja empotrada y, posteriormente, adquirir la parte vista para instalarla cuando esté todo listo. De esta manera, la planificación de la obra se simplifica y se gana en eficacia.



Mínima profundidad

El cuerpo empotrado se esconde bajo el suelo y necesita espacio mínimo de 80 mm y uno máximo de 160 mm.

Protección antihumedad

El cuerpo es totalmente estanco, evita las filtraciones de agua y protege contra la humedad.

Fácil de alinear

Una vez instalado el grifo, si no está correctamente alineado, hay la posibilidad de rectificar la orientación del caño en el momento de fijar el grifo.

Cuerpo fácil de nivelar

El cuerpo empotrado se puede nivelar durante la instalación para rectificar las irregularidades del suelo.







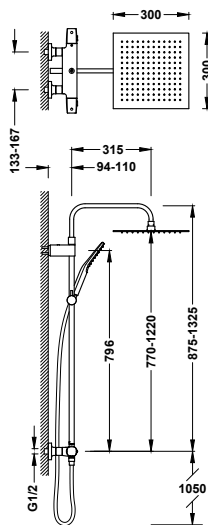

- Ⓐ Dos reguladores independientes, uno para llenar la bañera y el otro para la ducha de mano.
- Ⓑ La temperatura del regulador de la ducha está limitada para evitar quemaduras. (Caudal de 7 l/min).
- Ⓒ La salida para la bañera permite una temperatura más elevada para mantener más agua caliente dentro de la bañera. (Caudal de 22 l/min).
- Ⓓ Soporte de ducha inclinado para evitar el goteo al suelo cuando abrimos o cerramos.

GRIFOS TERMOSTÁTICOS MURALES



Conjunto de grifo termostático mural Over-wall de 2 vías para ducha





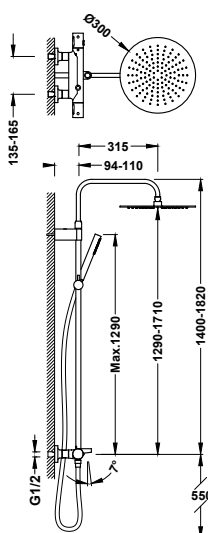

- Con inversor integrado en el regulador de caudal.
- Volante con bordes redondeados.
- Barra de ducha telescópica.
- Rociador de ducha orientable de acero inoxidable: 300x300 mm.
- Soporte deslizante y orientable para ducha de mano.
- Ducha de mano anticalcárea: 96x110 mm. (3 tipos de chorro).
- Flexo satinado.

-  19038702
-  19038702NM
-  19038702BM
-  19038702AC
-  19038702KMB
-  19038702OM
-  19038702OPM



Conjunto de grifo termostático mural Over-wall de 3 vías para bañera y ducha

- Con inversor integrado en el regulador de caudal.
- Volante redondo.
- Barra de ducha telescópica.
- Rociador de ducha orientable de acero inoxidable: Ø 300 mm.
- Soporte deslizante y orientable para ducha de mano.
- Ducha de mano anticalcárea de latón.
- Flexo satinado.

-  19031202
-  19031202NM
-  19031202BM
-  19031202AC
-  19031202KMB
-  19031202OM
-  19031202OPM





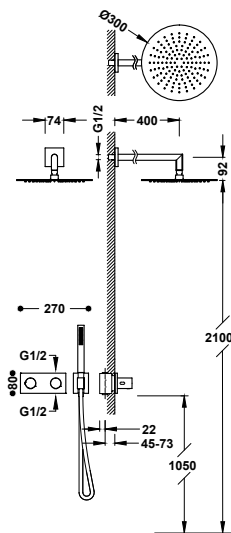



GRIFOS TERMOSTÁTICOS EMPOTRADOS



Kit de grifo termostático empotrado de 2 vías B-system para ducha

- Cuerpo empotrado termostático de instalación horizontal incluido.
- Regulador de caudal y distribuidor cerámico de 2 vías.
- Volante redondo.
- Brazo a pared con rociador de ducha orientable y de acero inoxidable: Ø 300 mm.
- Soporte para ducha de mano con toma de agua a pared.
- Ducha de mano anticalcárea de latón.
- Flexo satinado.

-  30735204
-  30735204NM
-  30735204AC
-  30735204OR
-  30735204OM
-  30735204OP
-  30735204OPM



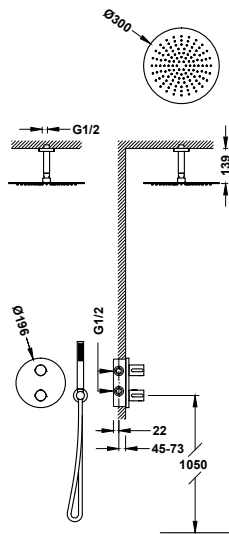

Kit de grifo termostático empotrado de 2 vías Therm-box para ducha

- Cuerpo empotrado incluido.
- Volante redondo con control de temperatura. Distribuidor cerámico de 2 vías.
- Brazo a techo con rociador de ducha orientable y de acero inoxidable: Ø 300 mm.
- Soporte para ducha de mano con toma de agua a pared.
- Ducha de mano anticalcárea de latón.
- Flexo satinado.

- 26225003
- 26225003NM
- 26225003BM
- 26225003AC
- 26225003KM
- 26225003KMB
- 26225003OR
- 26225003OM
- 26225003OP
- 26225003OPM

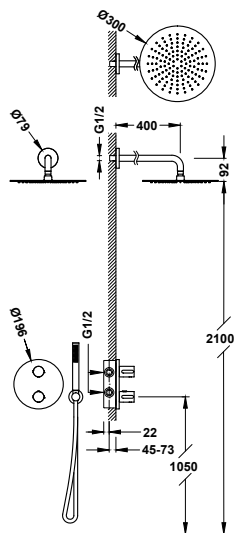

Kit de grifo termostático empotrado de 2 vías Therm-box para ducha

- Cuerpo empotrado incluido.
- Volante redondo con control de temperatura. Distribuidor cerámico de 2 vías.
- Brazo a pared con rociador de ducha orientable y de acero inoxidable: Ø 300 mm.
- Soporte para ducha de mano con toma de agua a pared.
- Ducha de mano anticalcárea de latón.
- Flexo satinado.

- 26225004
- 26225004NM
- 26225004BM
- 26225004AC
- 26225004KM
- 26225004KMB
- 26225004OR
- 26225004OM
- 26225004OP
- 26225004OPM



CUADRO

Una colección donde se miman todos los detalles. Con una línea estilizada, cuerpo compacto y de diseño actual, la serie Cuadro es artesanía pura para vestir los espacios más vanguardistas y aportar un toque de distinción.

Acabados disponibles:

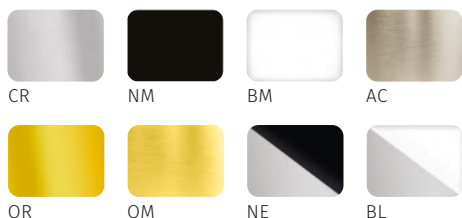





GRIFOS PARA LAVABO

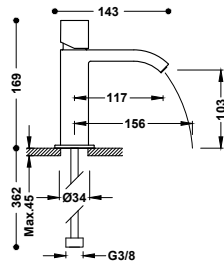

Grifo monomando para lavabo

Caño cerrado con salida del agua en cascada. Caudal limitado a 5 l/min. Latiguillos de alimentación flexibles G3/8. Se incluyen 2 llaves de regulación con filtro (ref: 9134525).

- 00610102
- 00610102D

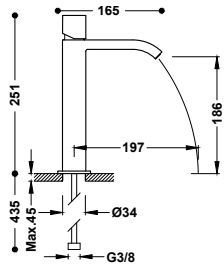

Grifo monomando alto para lavabo

Caño cerrado con salida del agua en cascada. Caudal limitado a 5 l/min. Latiguillos de alimentación flexibles G3/8. Se incluyen 2 llaves de regulación con filtro (ref: 9134525).

- 00661002

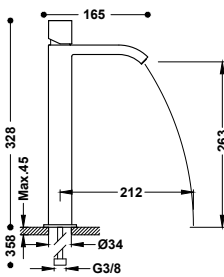

Grifo monomando XXL para lavabo

Caño cerrado con salida del agua en cascada. Caudal limitado a 5 l/min. Latiguillos de alimentación flexibles G3/8. Se incluyen 2 llaves de regulación con filtro (ref: 9134525).

- 00681002

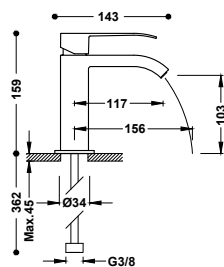

Grifo monomando para lavabo

Caño cerrado con salida del agua en cascada. Caudal limitado a 5 l/min. Latiguillos de alimentación flexibles G3/8. Se incluyen 2 llaves de regulación con filtro (ref: 9134525).

- 00610101
- 00610101D

- 00610101NM
- 00610101BM
- 00610101AC
- 00610101OR
- 00610101OM
- 00610101NE
- 00610101BL

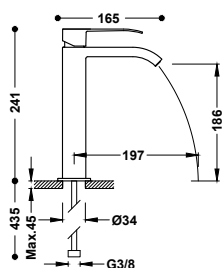

Grifo monomando alto para lavabo

Caño cerrado con salida del agua en cascada. Caudal limitado a 5 l/min. Latiguillos de alimentación flexibles G3/8. Se incluyen 2 llaves de regulación con filtro (ref: 9134525).

- 00661001

- 00661001NM
- 00661001BM
- 00661001AC
- 00661001OR
- 00661001OM
- 00661001NE
- 00661001BL



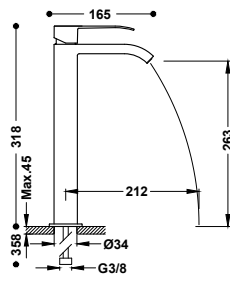

Grifo monomando XXL para lavabo

Caño cerrado con salida del agua en cascada. Caudal limitado a 5 l/min. Latiguillos de alimentación flexibles G3/8. Se incluyen 2 llaves de regulación con filtro (ref: 9134525).



- 00681001
- 00681001NM
- 00681001BM
- 00681001AC
- 00681001OR
- 00681001OM
- 00681001NE
- 00681001BL

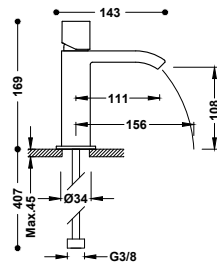

Grifo monomando para lavabo

Caño abierto con salida del agua en cascada. Latiguillos de alimentación flexibles G3/8. Se incluyen 2 llaves de regulación con filtro (ref: 9134525).



- 00611002
- 00611002D
- 00611002NE
- 00611002BL

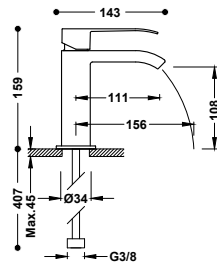

Grifo monomando para lavabo

Caño abierto con salida del agua en cascada. Latiguillos de alimentación flexibles G3/8. Se incluyen 2 llaves de regulación con filtro (ref: 9134525).



- 00611001
- 00611001D
- 00611001NE
- 00611001BL

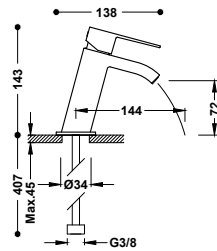

Grifo monomando inclinado para lavabo

Caño cerrado con salida del agua en cascada. Caudal limitado a 5 l/min. Latiguillos de alimentación flexibles G3/8. Se incluyen 2 llaves de regulación con filtro (ref: 9134525).



- 00620101
- 00620101NM
- 00620101BM
- 00620101AC
- 00620101OR
- 00620101OM

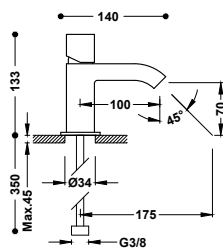

Grifo monomando para lavabo

Latiguillos de alimentación flexibles G3/8.



- 107103
- 107103DA

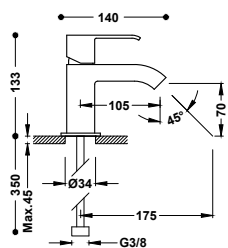

Grifo monomando para lavabo
Latiguillos de alimentación flexibles G3/8.

- 106103
- 106103DA

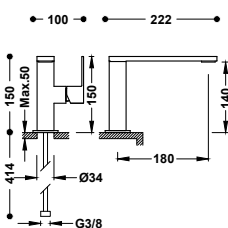

Grifo monomando con maneta lateral para lavabo
Latiguillos de alimentación flexibles G3/8.

- 10620501
- 00620501NM
- 00620501BM
- 00620501AC
- 00620501OR
- 00620501OM

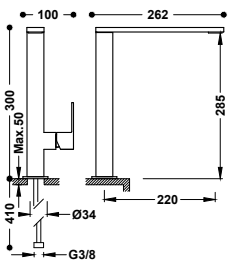

Grifo monomando alto con maneta lateral para lavabo
Latiguillos de alimentación flexibles G3/8.

- 00648501
- 00648501NM
- 00648501BM
- 00648501AC
- 00648501OR
- 00648501OM

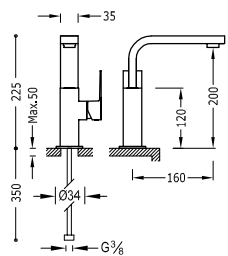

Grifo monomando con maneta lateral para lavabo
Latiguillos de alimentación flexibles G3/8.

- 106603

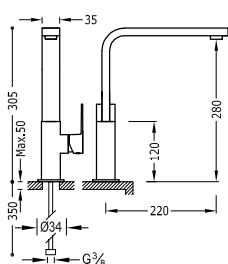

Grifo monomando alto con maneta lateral para lavabo
Latiguillos de alimentación flexibles G3/8.

- 106604



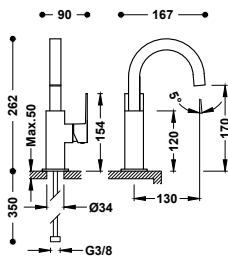

Grifo monomando con maneta lateral para lavabo

Latiguillos de alimentación flexibles G3/8.



9130190

- 106605
- 00660502NM
- 00660502BM
- 00660502AC
- 00660502OR
- 00660502OM

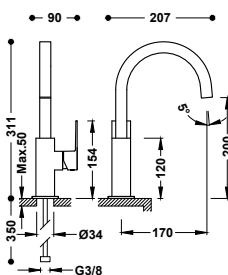

Grifo monomando alto con maneta lateral para lavabo

Latiguillos de alimentación flexibles G3/8.



9130190

- 106606
- 00660602NM
- 00660602BM
- 00660602AC
- 00660602OR
- 00660602OM

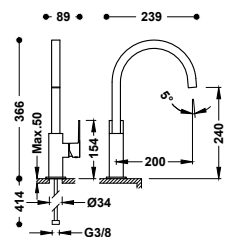

Grifo monomando XXL con maneta lateral para lavabo

Latiguillos de alimentación flexibles G3/8.



9130190

- 106607
- 00660702NM
- 00660702BM
- 00660702AC
- 00660702OR
- 00660702OM

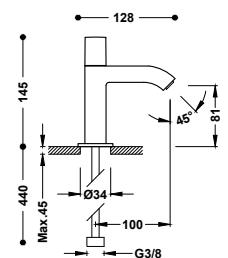

Grifo de 1 agua para lavabo

Con latiguillo de alimentación flexible G3/8.



910829510

- 107503
- 00750301NM
- 00750301BM
- 00750301AC
- 00750301OR
- 00750301OM

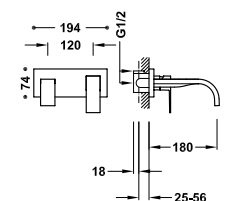

Grifo monomando empotrado para lavabo

Cuerpo empotrado indivisible con amortiguadores acústicos. Junta antihumedad. Caño de 180 mm.



29902801

- 00630011
- 00630011NM
- 00630011BM
- 00630011AC
- 00630011OR
- 00630011OM

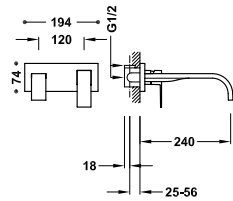

Grifo monomando empotrado para lavabo

Cuerpo empotrado indivisible con amortiguadores acústicos. Junta antihumedad. Caño de 240 mm.



00630012

- 00630012NM
- 00630012BM
- 00630012AC
- 00630012OR
- 00630012OM

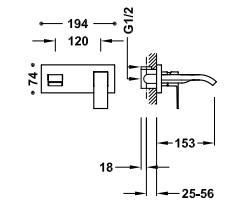

Grifo monomando empotrado para lavabo

Cuerpo empotrado indivisible con amortiguadores acústicos. Junta antihumedad. Caño de 153 mm. Caño cerrado, salida del agua en cascada.



00630013

- 00630013NM
- 00630013BM
- 00630013AC
- 00630013OR
- 00630013OM

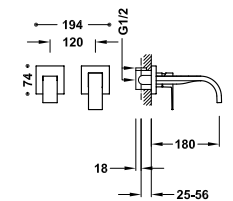

Grifo monomando empotrado para lavabo

Cuerpo empotrado indivisible con amortiguadores acústicos. Junta antihumedad. Caño de 180 mm.



00630001

- 00630001NM
- 00630001BM
- 00630001AC
- 00630001OR
- 00630001OM

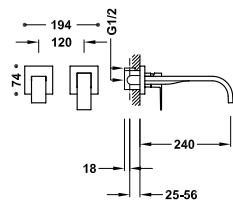

Grifo monomando empotrado para lavabo

Cuerpo empotrado indivisible con amortiguadores acústicos. Junta antihumedad. Caño de 240 mm.



00630002

- 00630002NM
- 00630002BM
- 00630002AC
- 00630002OR
- 00630002OM

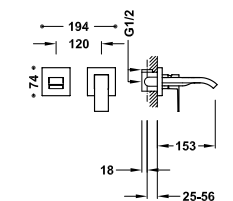

Grifo monomando empotrado para lavabo

Cuerpo empotrado indivisible con amortiguadores acústicos. Junta antihumedad. Caño de 153 mm. Caño cerrado, salida del agua en cascada.



00630003

- 00630003NM
- 00630003BM
- 00630003AC
- 00630003OR
- 00630003OM

GRIFOS PARA BIDÉ

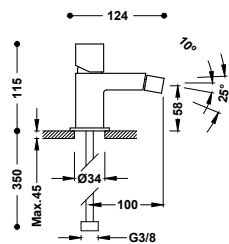

Grifo monomando para bidé
Rótula orientable. Latiguillos de alimentación flexibles G3/8.



- 00712001
- 00712001D
- 00712001NM
- 00712001BM
- 00712001AC
- 00712001OR
- 00712001OM
- 00712001NE
- 00712001BL

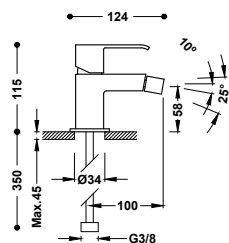

Grifo monomando para bidé
Rótula orientable. Latiguillos de alimentación flexibles G3/8.



- 00612001
- 00612001D
- 00612001NM
- 00612001BM
- 00612001AC
- 00612001OR
- 00612001OM
- 00612001NE
- 00612001BL

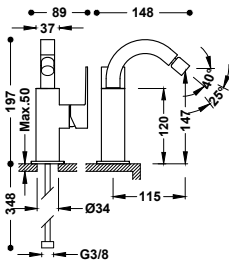

Grifo monomando con maneta lateral para bidé
Rótula orientable. Latiguillos de alimentación flexibles G3/8.



- 106124
- 00612402NM
- 00612402BM
- 00612402AC
- 00612402OR
- 00612402OM

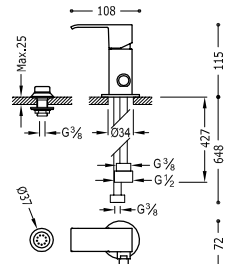

Grifo monomando para bidé con transferencia a ducha
Latiguillos de alimentación flexibles G3/8.



- 00613001
- 00613001NM
- 00613001BM
- 00613001AC
- 00613001OR
- 00613001OM



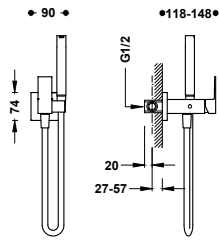

Grifo monomando empotrado con ducha para inodoro
 Con agua fría o caliente. Ducha de mano con racor limitador a 5 l/min. y sistema antigoteo. Soporte fijo para la ducha de mano instalable a derecha o izquierda. Flexo satinado.



- 00612301
- 00612301NM
- 00612301BM
- 00612301AC
- 00612301OR
- 00612301OM

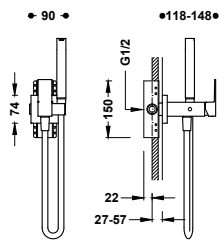

Grifo monomando empotrado con ducha para inodoro
 Opción para paredes de Pladur. Con agua fría o caliente. Ducha de mano con racor limitador a 5 l/min. y sistema antigoteo. Soporte fijo para la ducha de mano instalable a derecha o izquierda. Flexo satinado.



- 00612302
- 00612302NM
- 00612302BM
- 00612302AC



Accesorio porta toallas para grifo con ducha para inodoro
 Soporte instalable a derecha o izquierda (para ref.: 00612301, 00612302). Long: 180 mm.

- 03412402
- 03412402NM
- 03412402BM
- 03412402AC
- 03412402OR
- 03412402OM



GRIFOS MURALES

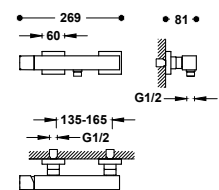

Grifo monomando mural para ducha
 Ducha de mano anticalcárea de latón. Soporte orientable para ducha de mano. Flexo satinado.



- 107167
- 00716703NM
- 00716703BM
- 50716703
- 00716703OR
- 00716703OM

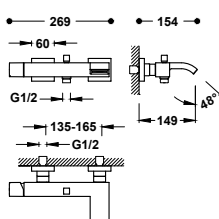

Grifo monomando mural para bañera y ducha
 Con salida de agua en cascada. Ducha de mano anticalcárea de latón. Soporte orientable para ducha de mano. Flexo satinado.



- 10717002
- 0071700203NM
- 0071700203BM
- 5071700203
- 0071700203OR
- 0071700203OM

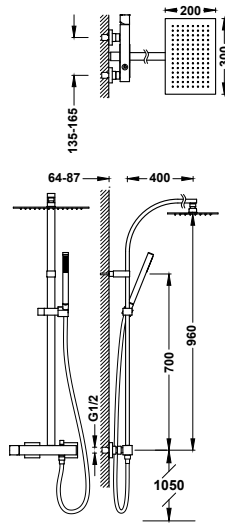

Conjunto de grifo monomando mural de 2 vías para ducha

00719102

- Rociador de ducha orientable de acero inoxidable: 300x200 mm.
- Soporte deslizante y orientable para ducha de mano.
- Ducha de mano anticalcárea de latón.
- Flexo satinado.

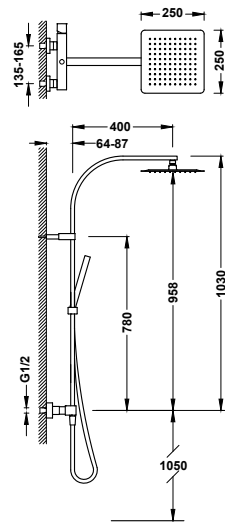

Conjunto de grifo monomando mural de 2 vías para ducha

00719101

- Rociador de ducha orientable de acero inoxidable: 250x250 mm.
- Soporte deslizante y orientable para ducha de mano.
- Ducha de mano anticalcárea de latón.
- Flexo satinado.

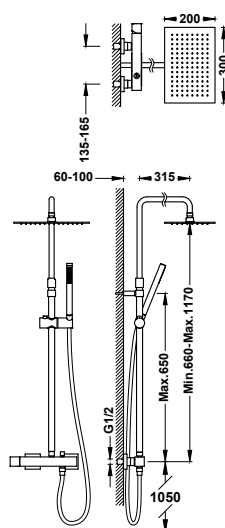

Conjunto de grifo monomando mural de 2 vías para ducha

00719702

- Rociador de ducha orientable de acero inoxidable: 300x200 mm.
- Barra de ducha telescópica.
- Soporte deslizante y orientable para ducha de mano.
- Ducha de mano anticalcárea de latón.
- Flexo satinado.



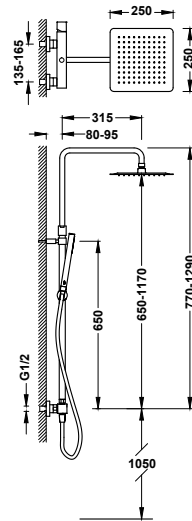

Conjunto de grifo monomando mural de 2 vías para ducha

00719701

- Rociador de ducha orientable de acero inoxidable: 250x250 mm.
- Barra de ducha telescópica.
- Soporte deslizante y orientable para ducha de mano.
- Ducha de mano anticalcárea de latón.
- Flexo satinado.



GRIFOS EMPOTRADOS RAPID-BOX

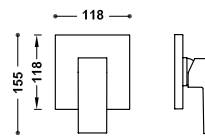

Pieza vista para caja empotrada de 1 vía Rapid-box

10627810

Sólo parte vista. Incluye placa embellecedora, mando, casquillo y tornillo de fijación oculto. **Caja empotrada no incluida.**

- 10627810NM
- 10627810BM
- 10627810AC
- 10627810OR
- 10627810OM



Caja empotrada de 1 vía Rapid-box con grifo monomando para ducha

20827810

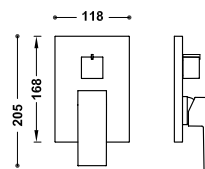
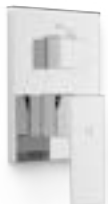

Pieza vista para caja empotrada de 2 vías Rapid-box

10628110

Sólo parte vista. Incluye placa embellecedora, mando, volante distribuidor y tornillo de fijación oculto. **Caja empotrada no incluida.**

- 10628110NM
- 10628110BM
- 10628110AC
- 10628110OR
- 10628110OM



Caja empotrada de 2 vías Rapid-box con grifo monomando para ducha y bañera

20828110



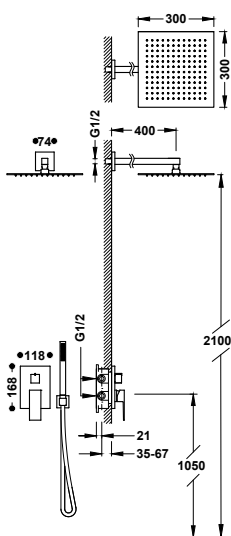

Kit de grifo monomando empotrado de 2 vías Rapid-box para ducha

- Cuerpo empotrado incluido.
- Distribuidor cerámico de 2 vías.
- Brazo a pared con rociador de ducha orientable y de acero inoxidable: 300x300 mm.
- Soporte para ducha de mano con toma de agua a pared.
- Ducha de mano anticalcárea de latón.
- Flexo satinado.

- 00628004
- 00628004NM
- 00628004BM
- 00628004AC
- 00628004OR
- 00628004OM

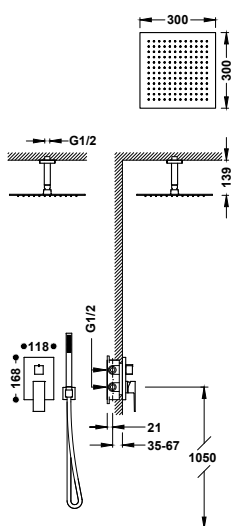

Kit de grifo monomando empotrado de 2 vías Rapid-box para ducha

- Cuerpo empotrado incluido.
- Distribuidor cerámico de 2 vías.
- Brazo a techo con rociador de ducha orientable y de acero inoxidable: 300x300 mm.
- Soporte para ducha de mano con toma de agua a pared.
- Ducha de mano anticalcárea de latón.
- Flexo satinado.

- 00628003
- 00628003NM
- 00628003BM
- 00628003AC
- 00628003OR
- 00628003OM

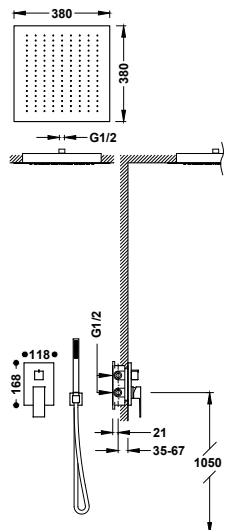

Kit de grifo monomando empotrado de 2 vías Rapid-box para ducha

- Cuerpo empotrado incluido.
- Distribuidor cerámico de 2 vías.
- Rociador de ducha empotrado a techo de acero inoxidable: 380x380 mm.
- Soporte para ducha de mano con toma de agua a pared.
- Ducha de mano anticalcárea de latón.
- Flexo satinado.

- 00628005
- 00628005NM
- 00628005BM
- 00628005AC
- 00628005OR
- 00628005OM



Kit de grifo monomando empotrado de 2 vías Rapid-box para bañera y ducha

- Cuerpo empotrado incluido.
- Distribuidor cerámico de 2 vías.
- Caño fijo de bañera a pared.
- Soporte para ducha de mano con toma de agua a pared.
- Ducha de mano anticalcárea de latón.
- Flexo satinado.

- 00628006
- 00628006NM
- 00628006BM
- 00628006AC
- 00628006OR
- 00628006OM

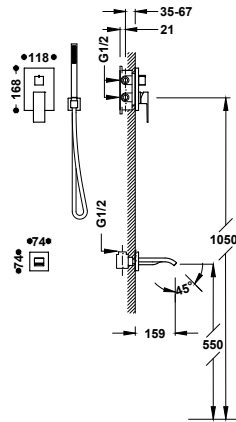

GRIFOS EMPOTRADOS

Grifo monomando empotrado de 1 vía para ducha
Cuerpo empotrado incluido.

■ 106177

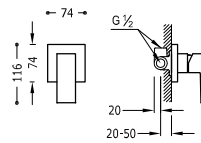

Alargadera para grifo monomando empotrado de 1 vía para ducha

■ 10617710

Grifo monomando empotrado de 2 vías para bañera y ducha
Cuerpo empotrado incluido. Inversor de 2 vías.

■ 106180

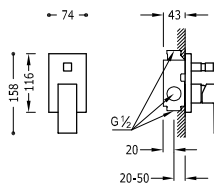
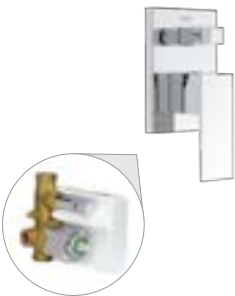

Set de prolongación para los grifos monomando empotrado de 2 vías

■ 10618010

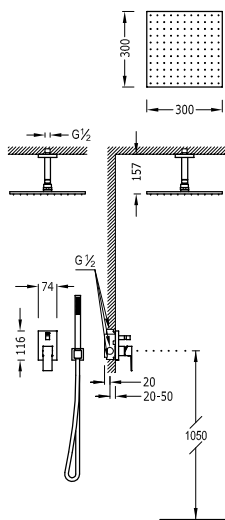

Kit de grifo monomando empotrado de 2 vías para ducha

00618080

- Cuerpo empotrado incluido.
- Inversor de 2 vías.
- Brazo a techo con rociador de ducha orientable y de acero inoxidable: 300x300 mm.
- Soporte para ducha de mano con toma de agua a pared.
- Ducha de mano anticalcárea de latón.
- Flexo satinado.



9130190

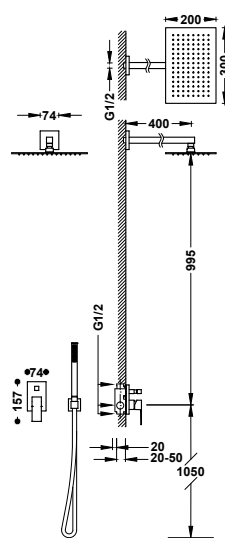

Kit de grifo monomando empotrado de 2 vías para ducha

00698003

- Cuerpo empotrado incluido.
- Inversor de 2 vías.
- Brazo a pared con rociador de ducha orientable y de acero inoxidable: 300x200 mm.
- Soporte para ducha de mano con toma de agua a pared.
- Ducha de mano anticalcárea de latón.
- Flexo satinado.



9130190

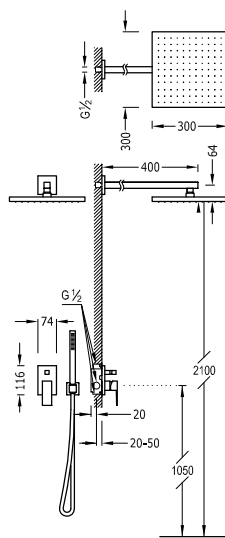

Kit de grifo monomando empotrado de 2 vías para ducha

106980

- Cuerpo empotrado incluido.
- Inversor de 2 vías.
- Brazo a pared con rociador de ducha orientable y de acero inoxidable: 300x300 mm.
- Soporte para ducha de mano con toma de agua a pared.
- Ducha de mano anticalcárea de latón.
- Flexo satinado.



9130190

GRIFOS PARA BAÑERA

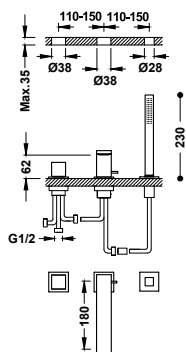

Grifo monomando para borde de bañera

00616106

- Inversor integrado en el caño de bañera.
- Ducha de mano anticalcárea de latón.
- Caño de bañera de 180 mm. Caudal: 3 bar - 13 l/min.
- Kit depósito opcional no incluido ref.: 20024501.



Depósito para grifería de borde de bañera

20024501

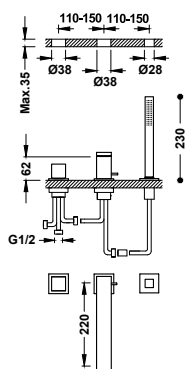

Grifo monomando para borde de bañera

00616104

- Inversor integrado en el caño de bañera.
- Ducha de mano anticalcárea de latón.
- Caño de bañera de 220 mm. Caudal: 3 bar - 13 l/min.
- Kit depósito opcional no incluido ref.: 20024501.



Depósito para grifería de borde de bañera

20024501

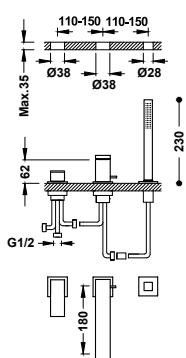

Grifo monomando para borde de bañera

00616105

- Inversor integrado en el caño de bañera.
- Ducha de mano anticalcárea de latón.
- Caño de bañera de 180 mm. Caudal: 3 bar - 13 l/m.
- Kit depósito opcional no incluido ref.: 20024501.

- 00616105NM
- 00616105BM
- 00616105AC
- 00616105OR
- 00616105OM



Depósito para grifería de borde de bañera

20024501

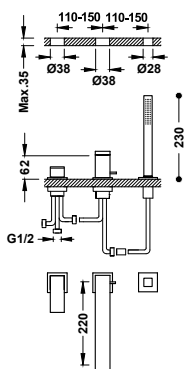

Grifo monomando para borde de bañera

- Inversor integrado en el caño de bañera.
- Ducha de mano anticalcárea de latón.
- Caño de bañera de 220 mm. Caudal: 3 bar - 13 l/m.
- Kit depósito opcional no incluido ref.: 20024501.

- 00616103
- 00616103NM
- 00616103BM
- 00616103AC
- 00616103OR
- 00616103OM



Depósito para grifería de borde de bañera

■ 20024501

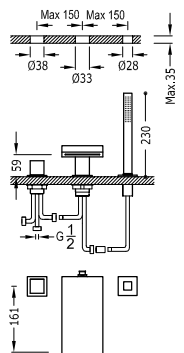

Grifo monomando para borde de bañera

- Inversor integrado en el caño de bañera.
- Ducha de mano anticalcárea de latón.
- Caño de bañera con salida del agua en cascada: 164 mm. Caudal: 3 bar -13 l/min.
- Kit depósito opcional no incluido ref.: 106245.

■ 10716102



Depósito para grifería de borde de bañera

■ 106245

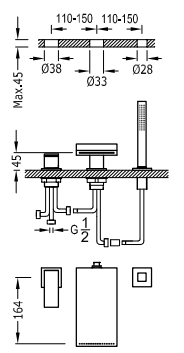

Grifo monomando para borde de bañera

- Inversor integrado en el caño de bañera.
- Ducha de mano anticalcárea de latón.
- Caño de bañera con salida del agua en cascada: 164 mm. Caudal: 3 bar -13 l/min.
- Kit depósito opcional no incluido ref.: 106245.

■ 10616102



Depósito para grifería de borde de bañera

■ 106245

GRIFOS TERMOSTÁTICOS MURALES

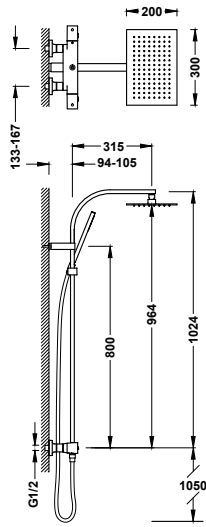

Conjunto de grifo termostático mural Over-wall de 2 vías para ducha

- Con inversor integrado en el regulador de caudal.
- Volante cuadrado.
- Rociador de ducha orientable de acero inoxidable: 300x200 mm.
- Soporte deslizante y orientable para ducha de mano.
- Ducha de mano anticalcárea de latón.
- Flexo satinado.

- 19039306
- 19039306NM
- 19039306BM
- 19039306AC
- 19039306OM



GRIFOS TERMOSTÁTICOS EMPOTRADOS

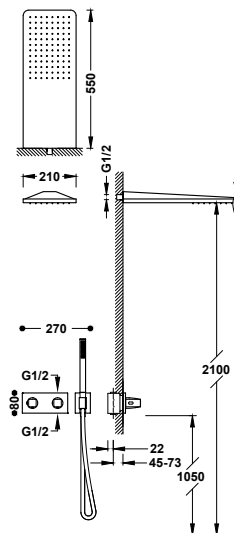

Kit de grifo termostático empotrado de 2 vías B-system para ducha

- Cuerpo empotrado termostático de instalación horizontal incluido.
- Regulador de caudal y distribuidor cerámico de 2 vías.
- Volante cuadrado-redondo.
- Rociador de ducha a pared de acero inoxidable: 210x550 mm.
- Soporte para ducha de mano con toma de agua a pared.
- Ducha de mano anticalcárea de latón.
- Flexo satinado.

- 30725205
- 30725205NM
- 30725205AC
- 30725205OR
- 30725205OM



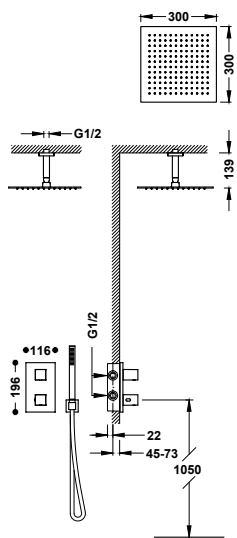

Kit de grifo termostático empotrado de 2 vías Therm-box para ducha

- Cuerpo empotrado incluido.
- Volante cuadrado con control de temperatura. Distribuidor cerámico de 2 vías.
- Brazo a techo con rociador de ducha orientable y de acero inoxidable: 300x300 mm.
- Soporte para ducha de mano con toma de agua a pared.
- Ducha de mano anticalcárea de latón.
- Flexo satinado.

- 00625003
- 00625003NM
- 00625003BM
- 00625003AC
- 00625003OR
- 00625003OM



29926828

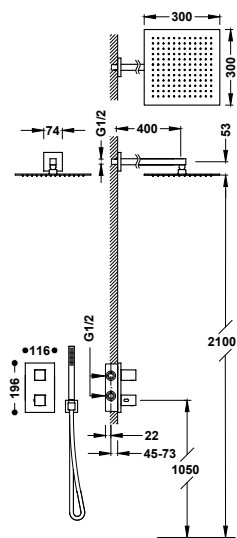

Kit de grifo termostático empotrado de 2 vías Therm-box para ducha

- Cuerpo empotrado incluido.
- Volante cuadrado con control de temperatura. Distribuidor cerámico de 2 vías.
- Brazo a pared con rociador de ducha orientable y de acero inoxidable: 300x300 mm.
- Soporte para ducha de mano con toma de agua a pared.
- Ducha de mano anticalcárea de latón.
- Flexo satinado.

- 00625004
- 00625004NM
- 00625004BM
- 00625004AC
- 00625004OR
- 00625004OM



29926828

LLAVES DE PASO

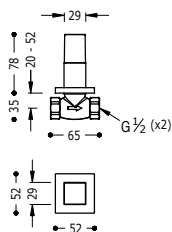

Llave de paso empotrada
Conexión a rosca hembra: 1/2".

00715501

- 00715501NM
- 00715501BM
- 00715501AC
- 00715501OR
- 00715501OM

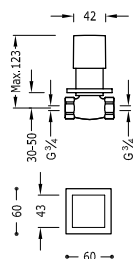

Llave de paso empotrada
Conexión a rosca hembra: 3/4".

107511

LOFT

El equilibrio entre las superficies planas y las redondeadas dan como resultado una colección muy amplia y versátil. Loft es la serie que mejor encaja y siempre acierta. Diseñada para el agua.

Acabados disponibles:

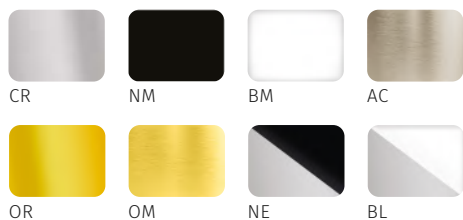











GRIFOS PARA LAVABO

Grifo monomando para lavabo

Latiguillos de alimentación flexibles G3/8.

-  20010302
-  20010302D

-  20010302NM
-  20010302BM
-  20010302AC
-  20010302OR
-  20010302OM
-  20010302NE
-  20010302BL

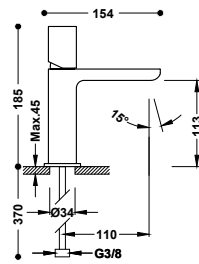

9130190

Grifo monomando para lavabo

Caño cerrado con salida del agua en cascada. Latiguillos de alimentación flexibles G3/8. Se incluyen 2 llaves de regulación con filtro (ref: 9134525).



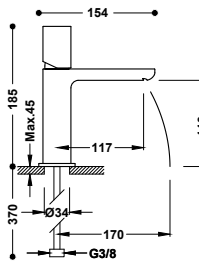





-  20010102
-  20010102D



9130190

Grifo monomando alto para lavabo

Latiguillos de alimentación flexibles G3/8.



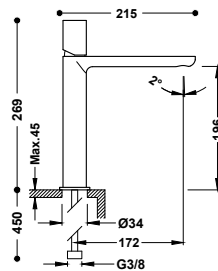





-  20020304
-  20020304NM
-  20020304BM
-  20020304AC
-  20020304OR
-  20020304OM
-  20020304NE
-  20020304BL



9130190

Grifo monomando XXL para lavabo

Latiguillos de alimentación flexibles G3/8.

-  20020306
-  20020306NM
-  20020306BM
-  20020306AC
-  20020306OR
-  20020306OM
-  20020306NE
-  20020306BL

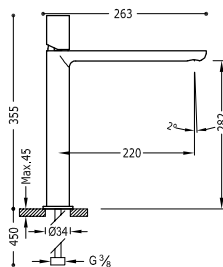

9130190

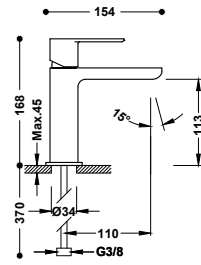

Grifo monomando para lavabo
Latiguillos de alimentación flexibles G3/8.



9130190

- 20010301
- 20010301D
- 20010301NM
- 20010301BM
- 20010301AC
- 20010301OR
- 20010301OM
- 20010301NE
- 20010301BL

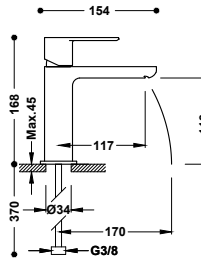

Grifo monomando para lavabo
Caño cerrado con salida del agua en cascada. Latiguillos de alimentación flexibles G3/8. Se incluyen 2 llaves de regulación con filtro (ref: 9134525).



9130190

- 20010101
- 20010101D

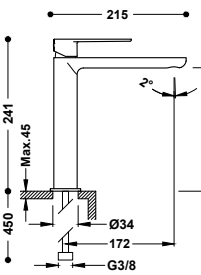

Grifo monomando alto para lavabo
Latiguillos de alimentación flexibles G3/8.



9130190

- 20020303
- 20020303NM
- 20020303BM
- 20020303AC
- 20020303OR
- 20020303OM
- 20020303NE
- 20020303BL

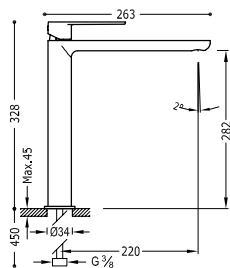

Grifo monomando XXL para lavabo
Latiguillos de alimentación flexibles G3/8.



9130190

- 20020305
- 20020305NM
- 20020305BM
- 20020305AC
- 20020305OR
- 20020305OM
- 20020305NE
- 20020305BL

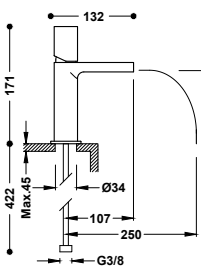

Grifo monomando para lavabo
Caño abierto con salida del agua en cascada. Latiguillos de alimentación flexibles G3/8. Se incluyen 2 llaves de regulación con filtro (ref: 9134525).



9130190

- 20011002
- 20011002NE
- 20011002BL

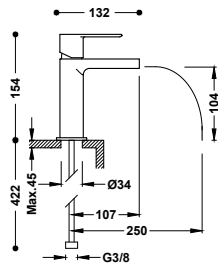

Grifo monomando para lavabo

Caño abierto con salida del agua en cascada. Latiguillos de alimentación flexibles G3/8. Se incluyen 2 llaves de regulación con filtro (ref: 9134525).

-  20011001
-  20011001NE
-  20011001BL





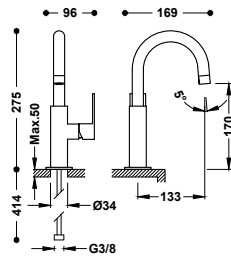





9130190



Grifo monomando con maneta lateral para lavabo

Latiguillos de alimentación flexibles G3/8.

-  20020504
-  20020504NM
-  20020504BM
-  20020504AC
-  20020504OR
-  20020504OM
-  20020504NE
-  20020504BL



9130190

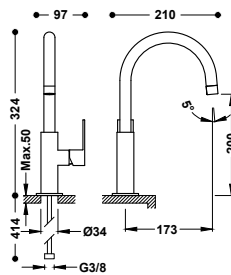

Grifo monomando alto con maneta lateral para lavabo

Latiguillos de alimentación flexibles G3/8.

-  20020505
-  20020505NM
-  20020505BM
-  20020505AC
-  20020505OR
-  20020505OM
-  20020505NE
-  20020505BL



9130190

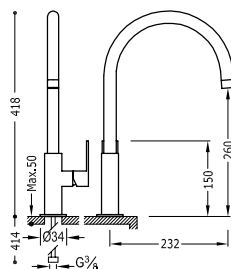

Grifo monomando XXL con maneta lateral para lavabo

Latiguillos de alimentación flexibles G3/8.

-  20020506
-  20020506NM
-  20020506BM
-  20020506AC
-  20020506OR
-  20020506OM
-  20020506NE
-  20020506BL



9130190

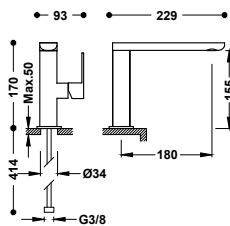

Grifo monomando con maneta lateral para lavabo

Latiguillos de alimentación flexibles G3/8.



- 20020501
- 20020501NM
- 20020501BM
- 20020501AC
- 20020501OR
- 20020501OM
- 20020501NE
- 20020501BL

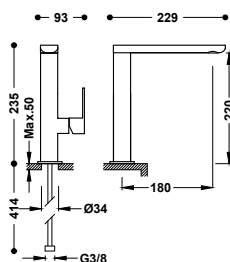

Grifo monomando alto con maneta lateral para lavabo

Latiguillos de alimentación flexibles G3/8.



- 20020502
- 20020502NM
- 20020502BM
- 20020502AC
- 20020502OR
- 20020502OM
- 20020502NE
- 20020502BL

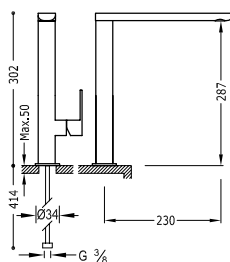

Grifo monomando XXL con maneta lateral para lavabo

Latiguillos de alimentación flexibles G3/8.



- 20020503
- 20020503NM
- 20020503BM
- 20020503AC
- 20020503OR
- 20020503OM
- 20020503NE
- 20020503BL

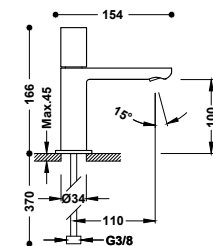

Grifo de 1 agua para lavabo

Con latiguillo de alimentación flexible G3/8.



- 20050301
- 20050301NM
- 20050301BM
- 20050301AC
- 20050301OR
- 20050301OM

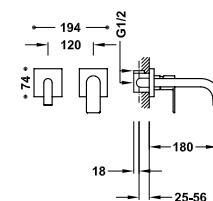

Grifo monomando empotrado para lavabo

Cuerpo empotrado indivisible con amortiguadores acústicos. Junta antihumedad. Caño de 180 mm.



- 20030001
- 20030001NM
- 20030001BM
- 20030001AC
- 20030001OR
- 20030001OM

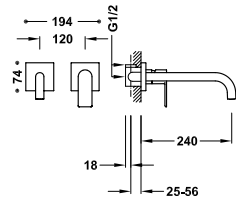

Grifo monomando empotrado para lavabo

Cuerpo empotrado indivisible con amortiguadores acústicos. Junta antihumedad. Caño de 240 mm.



- 20030002
- 20030002NM
- 20030002BM
- 20030002AC
- 20030002OR
- 20030002OM

GRIFOS PARA BIDÉ

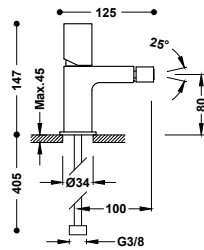

Grifo monomando para bidé

Rótula orientable. Latiguillos de alimentación flexibles G3/8.

- 20012002
- 20012002NM
- 20012002BM
- 20012002AC
- 20012002OR
- 20012002OM
- 20012002NE
- 20012002BL

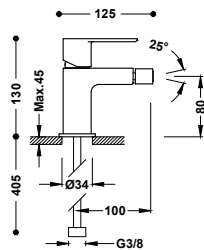

Grifo monomando para bidé

Rótula orientable. Latiguillos de alimentación flexibles G3/8.

- 20012001
- 20012001NM
- 20012001BM
- 20012001AC
- 20012001OR
- 20012001OM
- 20012001NE
- 20012001BL

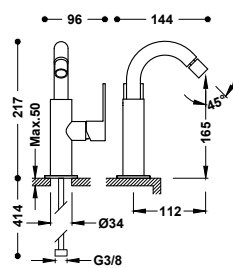

Grifo monomando con maneta lateral para bidé

Rótula orientable. Latiguillos de alimentación flexibles G3/8.

- 20022401
- 20022401NM
- 20022401BM
- 20022401AC
- 20022401OR
- 20022401OM
- 20022401NE
- 20022401BL

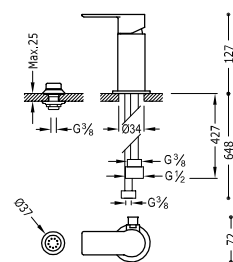

Grifo monomando para bidé con transferencia a duchita

Con inversor para duchita. Latiguillos de alimentación flexibles G3/8.

- 20013001
- 20013001NM
- 20013001BM
- 20013001AC
- 20013001KM
- 20013001KMB
- 20013001OR
- 20013001OM
- 20013001OP
- 20013001OPM



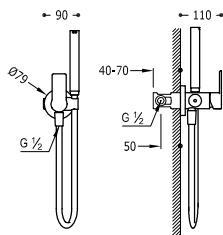

Grifo monomando empotrado con ducha para inodoro

Con agua fría o caliente. Ducha de mano con racor limitador a 5 l/min. y sistema antigoteo. Soporte fijo para la ducha de mano instalable a derecha o izquierda. Flexo satinado.



- 20522301
- 20522301NM
- 20522301BM
- 20522301AC
- 20522301OR
- 20522301OM

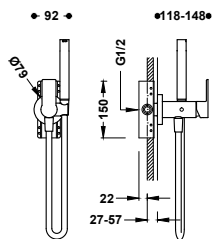

Grifo monomando empotrado con ducha para inodoro

Opción para paredes de Pladur. Con agua fría o caliente. Ducha de mano con racor limitador a 5 l/min. y sistema antigoteo. Soporte fijo para la ducha de mano instalable a derecha o izquierda. Flexo satinado.



- 20522201
- 20522201NM
- 20522201BM
- 20522201AC



Accesorio porta toallas para grifo con ducha para inodoro

Soporte instalable a derecha o izquierda (para ref.: 134122, 134123, 181122, 181123, 181222, 181223, 20522201, 20522301). Long: 180 mm.



- 03412401
- 03412401NM
- 03412401BM
- 03412401AC
- 03412401OR
- 03412401OM



GRIFOS MURALES

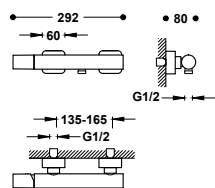

Grifo monomando mural para ducha

Ducha de mano anticalcárea. Soporte orientable para ducha de mano. Flexo satinado.



- 20016701
- 20016701NM
- 20016701BM
- 20016701AC
- 20016701OR
- 20016701OM

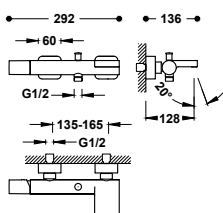

Grifo monomando mural para bañera y ducha

Ducha de mano anticalcárea. Con salida de agua en cascada. Soporte orientable para ducha de mano. Flexo satinado.



- 20017001
- 20017001NM
- 20017001BM
- 20017001AC
- 20017001OR
- 20017001OM

GRIFOS EMPOTRADOS

Grifo monomando empotrado de 1 vía para ducha
Cuerpo empotrado incluido.

20017701

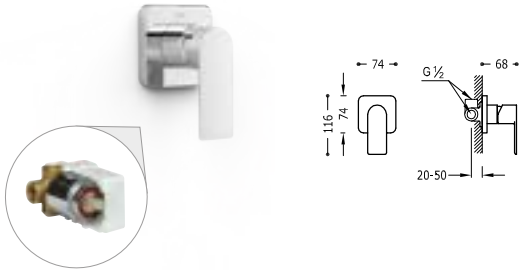

Grifo monomando empotrado de 2 vías para bañera y ducha
Cuerpo empotrado incluido. Inversor de 2 vías.

20018001

- 20018001NM
- 20018001BM
- 20018001AC
- 20018001OR
- 20018001OM

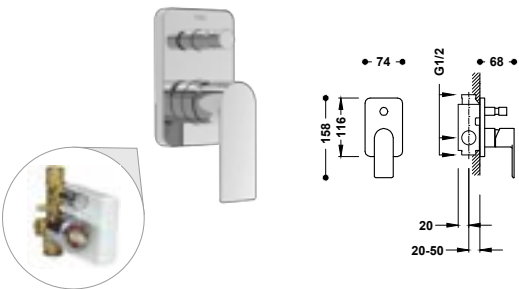

Set de prolongación para los grifos monomando empotrado de 2 vías

20018010

- 20018010OR
- 20018010OM



Kit de grifo monomando empotrado de 2 vías para ducha

20018011

- Cuerpo empotrado incluido.
- Inversor de 2 vías.
- Brazo a pared con rociador de ducha orientable y de acero inoxidable: 250x250mm.
- Soporte para ducha de mano con toma de agua a pared.
- Ducha de mano anticalcárea: 120x120 mm. (3 tipos de chorro).
- Flexo satinado.

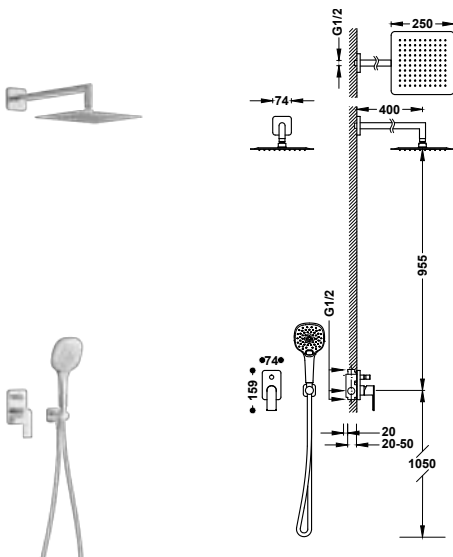

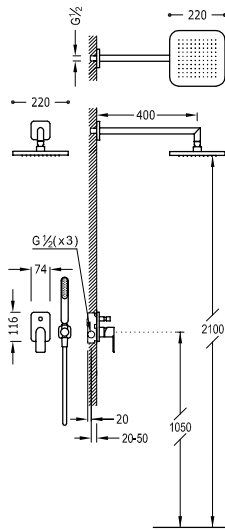

Kit de grifo monomando empotrado de 2 vías para ducha

20018002

- Cuerpo empotrado incluido.
- Inversor de 2 vías.
- Brazo a pared con rociador de ducha orientable: 220x220 mm.
- Soporte para ducha de mano con toma de agua a pared.
- Ducha de mano anticalcárea.
- Flexo satinado.



9130190

BELGUA

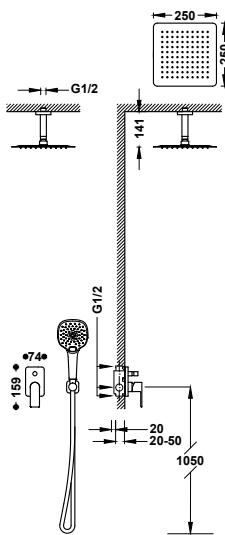

Kit de grifo monomando empotrado de 2 vías para ducha

20018009

- Cuerpo empotrado incluido.
- Inversor de 2 vías.
- Brazo a techo con rociador de ducha orientable y de acero inoxidable: 250x250mm.
- Soporte para ducha de mano con toma de agua a pared.
- Ducha de mano anticalcárea: 120x120 mm. (3 tipos de chorro).
- Flexo satinado.



9130190

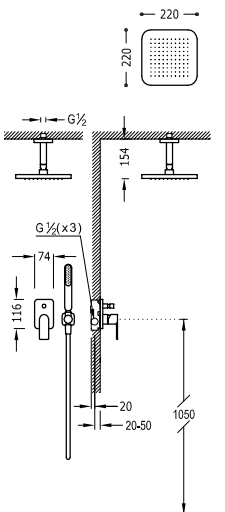

Kit de grifo monomando empotrado de 2 vías para ducha

20018080

- Cuerpo empotrado incluido.
- Inversor de 2 vías.
- Brazo a techo con rociador de ducha orientable: 220x220 mm.
- Soporte para ducha de mano con toma de agua a pared.
- Ducha de mano anticalcárea.
- Flexo satinado.



9130190

GRIFOS PARA BAÑERA

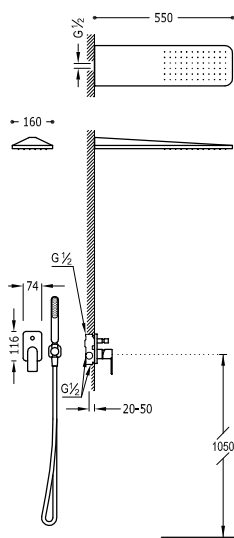

Kit de grifo monomando empotrado de 2 vías para ducha

- Cuerpo empotrado incluido.
- Inversor de 2 vías.
- Rociador de ducha a pared de acero inoxidable: 160x550 mm.
- Soporte para ducha de mano con toma de agua a pared.
- Ducha de mano anticalcárea.
- Flexo satinado.

- 20018005
- 20018005NM
- 20018005BM
- 20018005AC
- 20018005OR
- 20018005OM

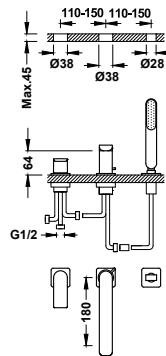

Grifo monomando para borde de bañera

- Inversor integrado en el caño de bañera.
- Ducha de mano anticalcárea.
- Caño de bañera de 180 mm. Caudal: 3 bar - 16 l/min.
- Kit depósito opcional no incluido ref.: 20324501.

- 20016203
- 20016203NM
- 20016203BM
- 20016203AC
- 20016203OR
- 20016203OM



Depósito para grifería de borde de bañera

- 20324501

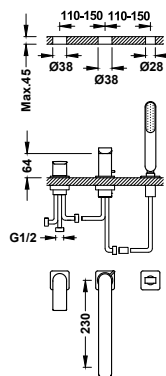

Grifo monomando para borde de bañera

- Inversor integrado en el caño de bañera.
- Ducha de mano anticalcárea.
- Caño de bañera de 230 mm. Caudal: 3 bar - 16 l/m.
- Kit depósito opcional no incluido ref.: 20324501.

- 20016201
- 20016201NM
- 20016201BM
- 20016201AC
- 20016201OR
- 20016201OM



Depósito para grifería de borde de bañera

- 20324501

GRIFOS TERMOSTÁTICOS MURALES

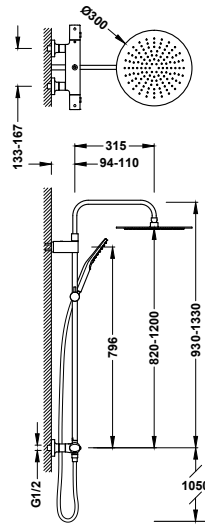

Conjunto de grifo termostático mural Over-wall de 2 vías para ducha

- Con inversor integrado en el regulador de caudal.
- Volante ovalado.
- Barra de ducha telescópica.
- Rociador de ducha orientable de acero inoxidable: Ø 300 mm.
- Soporte deslizante y orientable para ducha de mano.
- Ducha de mano anticalcárea: Ø 110 mm. (3 tipos de chorro).
- Flexo satinado.

19038705

19038705NM

19038705BM

19038705AC

19038705OM



29916833XX

GRIFOS TERMOSTÁTICOS EMPOTRADOS

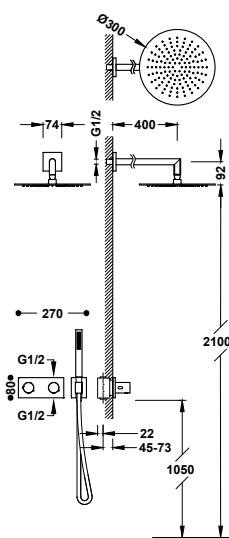

Kit de grifo termostático empotrado de 2 vías B-system para ducha

- Cuerpo empotrado termostático de instalación horizontal incluido.
- Regulador de caudal y distribuidor cerámico de 2 vías.
- Volante redondo.
- Brazo a pared con rociador de ducha orientable y de acero inoxidable: Ø 300 mm.
- Soporte para ducha de mano con toma de agua a pared.
- Ducha de mano anticalcárea de latón.
- Flexo satinado.

30735204

30735204NM

30735204AC

30735204OR

30735204OM



29926828

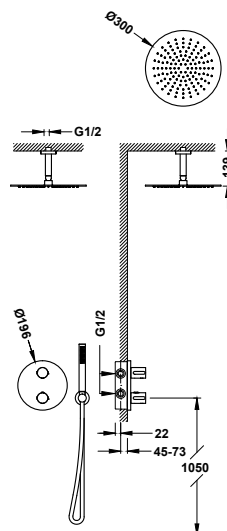

Kit de grifo termostático empotrado de 2 vías Therm-box para ducha

- Cuerpo empotrado incluido.
- Volante redondo con control de temperatura. Distribuidor cerámico de 2 vías.
- Brazo a techo con rociador de ducha orientable y de acero inoxidable: Ø 300 mm.
- Soporte para ducha de mano con toma de agua a pared.
- Ducha de mano anticalcárea de latón.
- Flexo satinado.

26225003

26225003NM

26225003BM

26225003AC

26225003OR

26225003OM



29926828

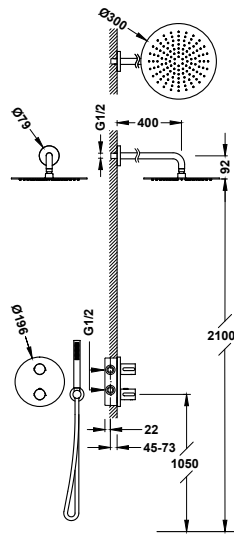

Kit de grifo termostático empotrado de 2 vías Therm-box para ducha

- Cuerpo empotrado incluido.
- Volante redondo con control de temperatura. Distribuidor cerámico de 2 vías.
- Brazo a pared con rociador de ducha orientable y de acero inoxidable: Ø 300 mm.
- Soporte para ducha de mano con toma de agua a pared.
- Ducha de mano anticalcárea de latón.
- Flexo satinado.

- 26225004
- 26225004NM
- 26225004BM
- 26225004AC
- 26225004OR
- 26225004OM



LLAVES DE PASO

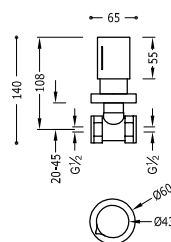

Llave de paso empotrada
Conexión a rosca hembra: 1/2".

- 06115501
- 06115501NM
- 06115501BM
- 06115501OR
- 06115501OM

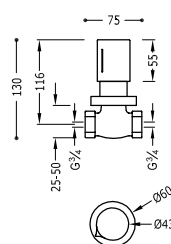

Llave de paso empotrada
Conexión a rosca hembra: 3/4".

- 06151101
- 06151101NM
- 06151101BM
- 06151101OR
- 06151101OM





FUJI

Las formas cónicas de la colección Fuji de Tres se representan en cada una de las piezas. Su silueta sinuosa es lo que consigue este dinamismo tan atractivo para los baños modernos y eleva la notoriedad y presencia de cada grifo.

Acabados disponibles:



CR



NM



AC







GRIFOS PARA LAVABO

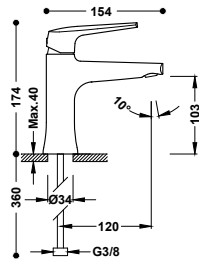

Grifo monomando para lavabo

Latiguillos de alimentación flexibles G3/8.

28110301

28110301NM

28110301AC



29902802

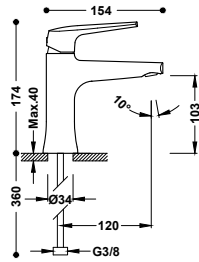

Grifo monomando ecoeficiente para lavabo

Latiguillos de alimentación flexibles G3/8.

28110401

28110401NM

28110401AC



29902803

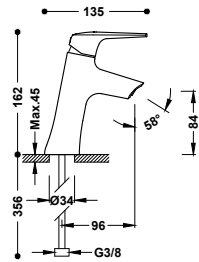

Grifo monomando inclinado para lavabo

Latiguillos de alimentación flexibles G3/8.

28190301

28190301NM

28190301AC



29902802

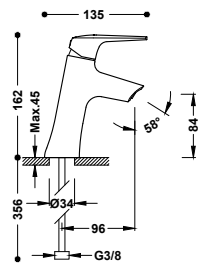

Grifo monomando inclinado ecoeficiente para lavabo

Latiguillos de alimentación flexibles G3/8.

28110402

28110402NM

28110402AC



29902803

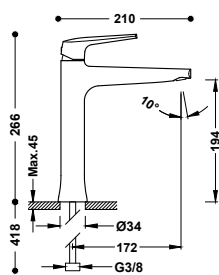

Grifo monomando alto para lavabo

Latiguillos de alimentación flexibles G3/8.

28120301

28120301NM

28120301AC



29902802

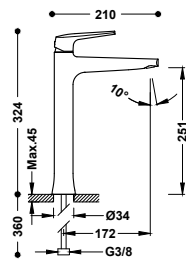

Grifo monomando XXL para lavabo
Latiguillos de alimentación flexibles G3/8.

28180301

28180301NM

28180301AC



29902802

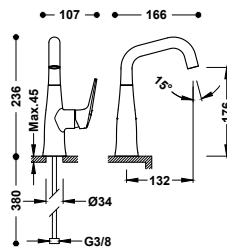

Grifo monomando con maneta lateral para lavabo
Latiguillos de alimentación flexibles G3/8.

28144701

28144701NM

28144701AC



29902804

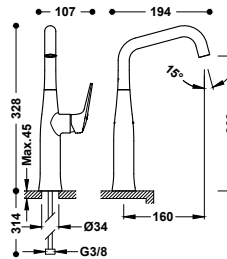

Grifo monomando alto con maneta lateral para lavabo
Latiguillos de alimentación flexibles G3/8.

28164701

28164701NM

28164701AC



29902804

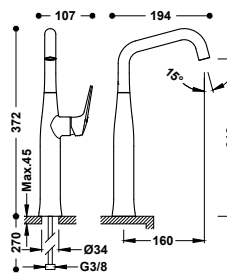

Grifo monomando XXL con maneta lateral para lavabo
Latiguillos de alimentación flexibles G3/8.

28184701

28184701NM

28184701AC



29902804

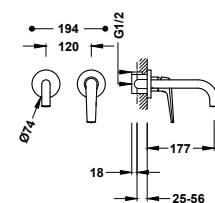

Grifo monomando empotrado para lavabo

Cuerpo empotrado indivisible con amortiguadores acústicos. Junta antihumedad. Caño de 177 mm.

28130001

28130001NM

28130001AC



29902801

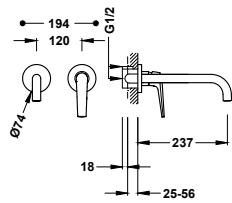

Grifo monomando empotrado para lavabo

Cuerpo empotrado indivisible con amortiguadores acústicos. Junta antihumedad. Caño de 237 mm.

■ 28130002

- 28130002NM
- 28130002AC

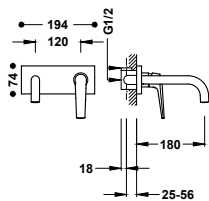

Grifo monomando empotrado para lavabo

Cuerpo empotrado indivisible con amortiguadores acústicos. Junta antihumedad. Caño de 180 mm.

■ 28130003

- 28130003NM
- 28130003AC

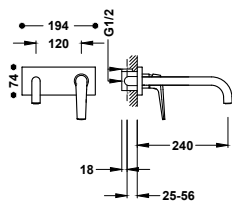

Grifo monomando empotrado para lavabo

Cuerpo empotrado indivisible con amortiguadores acústicos. Junta antihumedad. Caño de 240 mm.

■ 28130004

- 28130004NM
- 28130004AC



GRIFOS PARA BIDÉ

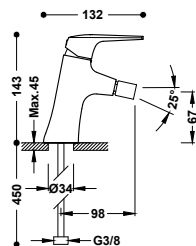

Grifo monomando para bidé

Rótula orientable. Latiguillos de alimentación flexibles G3/8.

■ 28112001

- 28112001NM
- 28112001AC

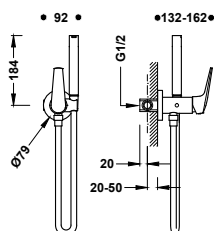

Grifo monomando empotrado con ducha para inodoro

Con agua fría o caliente. Ducha de mano con racor limitador a 5 l/min. y sistema antigoteo. Soporte fijo para la ducha de mano instalable a derecha o izquierda. Flexo satinado.

■ 28112301

- 28112301NM
- 28112301AC



GRIFOS MURALES

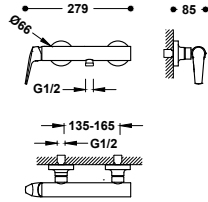

Grifo monomando mural para ducha

Ducha de mano anticalcárea: Ø 110 mm. (3 tipos de chorro). Soporte orientable para ducha de mano. Flexo satinado.

28116701

28116701NM

28116701AC



29902802

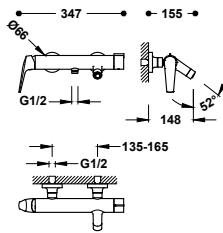

Grifo monomando mural para bañera y ducha

Ducha de mano anticalcárea: Ø 110 mm. (3 tipos de chorro). Soporte orientable para ducha de mano. Flexo satinado.

28117001

28117001NM

28117001AC



29903516

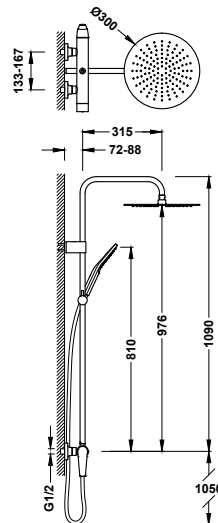

Conjunto de grifo monomando mural de 2 vías para ducha

- Rociador de ducha orientable de acero inoxidable: Ø 300 mm.
- Soporte deslizante y orientable para ducha de mano.
- Ducha de mano anticalcárea: Ø 110 mm. (3 tipos de chorro).
- Flexo satinado.

28119101

28119101NM

28119101AC



29903516

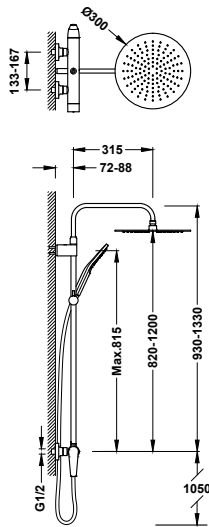

Conjunto de grifo monomando mural de 2 vías para ducha

- Rociador de ducha orientable de acero inoxidable: Ø 300 mm.
- Barra de ducha telescópica.
- Soporte deslizante y orientable para ducha de mano.
- Ducha de mano anticalcárea: Ø 110 mm. (3 tipos de chorro).
- Flexo satinado.

28119701

28119701NM

28119701AC



GRIFOS EMPOTRADOS RAPID-BOX

Pieza vista para caja empotrada de 1 vía Rapid-box

Sólo parte vista. Incluye placa embellecedora, mando, casquillo y tornillo de fijación oculto. **Caja empotrada no incluida.**

28127810

28127810NM

28127810AC

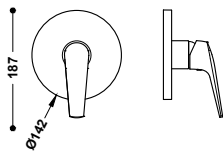

Caja empotrada de 1 vía Rapid-box con grifo monomando para ducha

20827810

N



Pieza vista para caja empotrada de 2 vías Rapid-box

Sólo parte vista. Incluye placa embellecedora, mando, volante distribuidor y tornillo de fijación oculto. **Caja empotrada no incluida.**

28128110

28128110NM

28128110AC

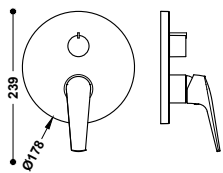

Caja empotrada de 2 vías Rapid-box con grifo monomando para ducha y bañera

20828110

N



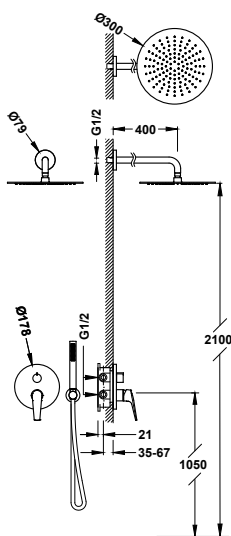

Kit de grifo monomando empotrado de 2 vías Rapid-box para ducha

- Cuerpo empotrado incluido.
- Distribuidor cerámico de 2 vías.
- Brazo a pared con rociador de ducha orientable y de acero inoxidable: Ø 300 mm.
- Soporte para ducha de mano con toma de agua a pared.
- Ducha de mano anticalcárea de latón.
- Flexo satinado.

28128004

28128004NM

28128004AC



29903508

GRIFOS TERMOSTÁTICOS MURALES

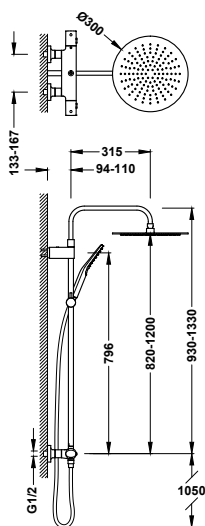

Conjunto de grifo termostático mural Over-wall de 2 vías para ducha

- Con inversor integrado en el regulador de caudal.
- Volante ovalado.
- Barra de ducha telescópica.
- Rociador de ducha orientable de acero inoxidable: Ø 300 mm.
- Soporte deslizante y orientable para ducha de mano.
- Ducha de mano anticalcárea: Ø 110 mm. (3 tipos de chorro).
- Flexo satinado.

19038705

19038705NM

19038705BM

19038705AC



29916833XX

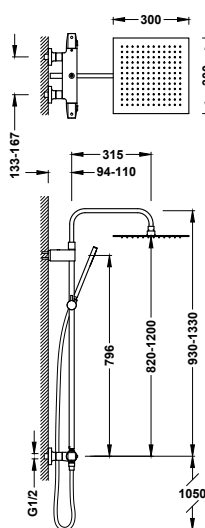

Conjunto de grifo termostático mural Over-wall de 2 vías para ducha

- Con inversor integrado en el regulador de caudal.
- Volante cuadrado-redondo.
- Barra de ducha telescópica.
- Rociador de ducha orientable de acero inoxidable: 300x300 mm.
- Soporte deslizante y orientable para ducha de mano.
- Ducha de mano anticalcárea de latón.
- Flexo satinado.

19039307

19039307NM

19039307BM

19039307AC



29916835XX

GRIFOS TERMOSTÁTICOS EMPOTRADOS

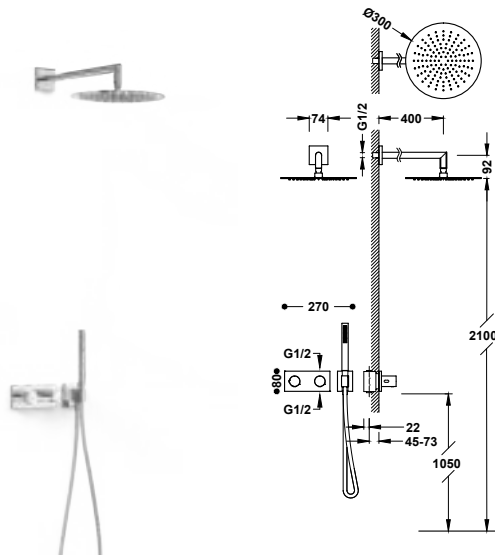

Kit de grifo termostático empotrado de 2 vías B-system para ducha

- Cuerpo empotrado termostático de instalación horizontal incluido.
- Regulador de caudal y distribuidor cerámico de 2 vías.
- Volante redondo.
- Brazo a pared con rociador de ducha orientable y de acero inoxidable: Ø 300 mm.
- Soporte para ducha de mano con toma de agua a pared.
- Ducha de mano anticalcárea de latón.
- Flexo satinado.

- 30735204
- 30735204NM
- 30735204AC

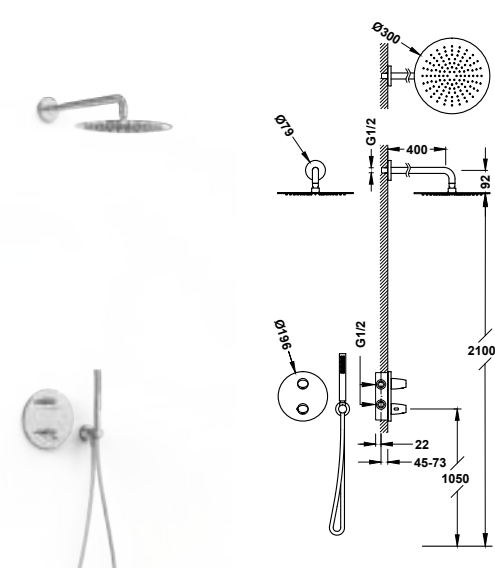

Kit de grifo termostático empotrado de 2 vías Therm-box para ducha

- Cuerpo empotrado incluido.
- Volante ovalado con control de temperatura. Distribuidor cerámico de 2 vías.
- Brazo a pared con rociador de ducha orientable y de acero inoxidable: Ø 300 mm.
- Soporte para ducha de mano con toma de agua a pared.
- Ducha de mano anticalcárea de latón.
- Flexo satinado.

- 28125004
- 28125004NM
- 28125004AC

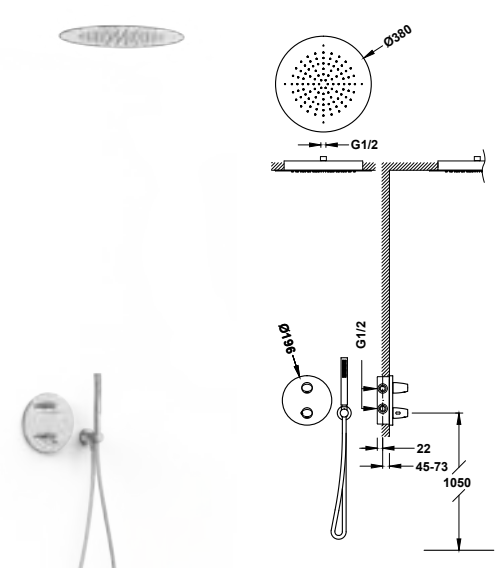

Kit de grifo termostático empotrado de 2 vías Therm-box para ducha

- Cuerpo empotrado incluido.
- Volante ovalado con control de temperatura. Distribuidor cerámico de 2 vías.
- Rociador de ducha empotrado a techo de acero inoxidable: Ø 380 mm.
- Soporte para ducha de mano con toma de agua a pared.
- Ducha de mano anticalcárea de latón.
- Flexo satinado.

- 28125005
- 28125005NM
- 28125005AC



PROJECT-TRES

Project-tres es la serie más especial de Tres. Adaptable a muchos entornos y con acabados sorprendentes, esta serie mezcla la innovación tecnológica con el diseño más versátil. Por algo será que a todo el mundo le gusta.

Acabados disponibles:

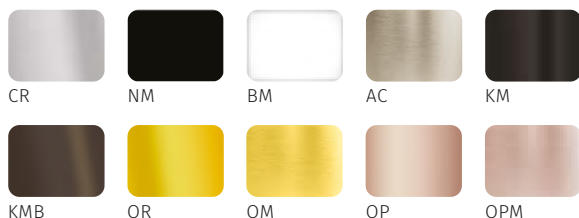













GRIFOS PARA LAVABO

Grifo monomando para lavabo

Latiguillos de alimentación flexibles G3/8.

-  21110302
-  21110302D

-  21110302NM
-  21110302BM
-  21110302AC
-  21110302KM
-  21110302KMB
-  21110302OR
-  21110302OM
-  21110302OP
-  21110302OPM

N

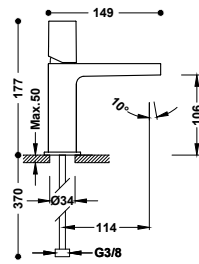









9130190

Grifo monomando alto para lavabo

Latiguillos de alimentación flexibles G3/8.

-  21120302

-  21120302NM
-  21120302BM
-  21120302AC
-  21120302KM
-  21120302KMB
-  21120302OR
-  21120302OM
-  21120302OP
-  21120302OPM

N

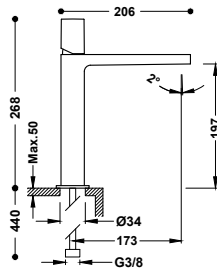









9130190

Grifo monomando XXL para lavabo

Latiguillos de alimentación flexibles G3/8.

-  21180302

-  21180302NM
-  21180302BM
-  21180302AC
-  21180302KM
-  21180302KMB
-  21180302OR
-  21180302OM
-  21180302OP
-  21180302OPM

N

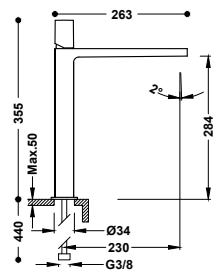









9130190

Grifo monomando para lavabo

Latiguillos de alimentación flexibles G3/8.

-  21110301
-  21110301D

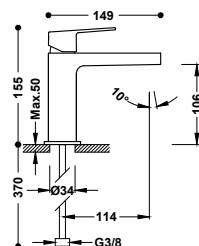

-  21110301NM
-  21110301BM
-  21110301AC
-  21110301KM
-  21110301KMB
-  21110301OR
-  21110301OM
-  21110301OP
-  21110301OPM



9130190



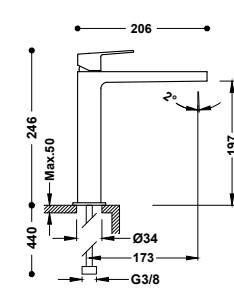

Grifo monomando alto para lavabo
Latiguillos de alimentación flexibles G3/8.

- 21120301
- 21120301NM
- 21120301BM
- 21120301AC
- 21120301KM
- 21120301KMB
- 21120301OR
- 21120301OM
- 21120301OP
- 21120301OPM



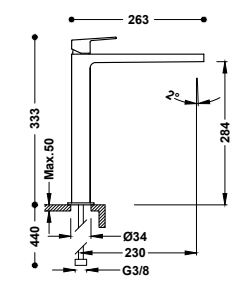

Grifo monomando XXL para lavabo
Latiguillos de alimentación flexibles G3/8.

- 21180301
- 21180301NM
- 21180301BM
- 21180301AC
- 21180301KM
- 21180301KMB
- 21180301OR
- 21180301OM
- 21180301OP
- 21180301OPM



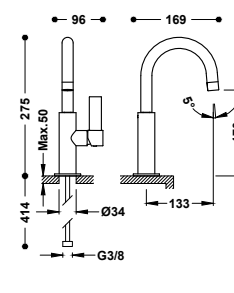

Grifo monomando con maneta lateral para lavabo
Latiguillos de alimentación flexibles G3/8.

- 21190401
- 21190401NM
- 21190401BM
- 21190401AC
- 21190401KM
- 21190401KMB
- 21190401OR
- 21190401OM
- 21190401OP
- 21190401OPM

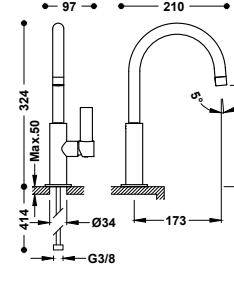

Grifo monomando alto con maneta lateral para lavabo
Latiguillos de alimentación flexibles G3/8.

- 21190501
- 21190501NM
- 21190501BM
- 21190501AC
- 21190501KM
- 21190501KMB
- 21190501OR
- 21190501OM
- 21190501OP
- 21190501OPM

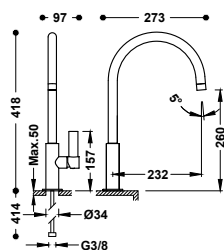

Grifo monomando XXL con maneta lateral para lavabo
 Latiguillos de alimentación flexibles G3/8.

- 21190601
- 21190601NM
- 21190601BM
- 21190601AC
- 21190601KM
- 21190601KMB
- 21190601OR
- 21190601OM
- 21190601OP
- 21190601OPM



N

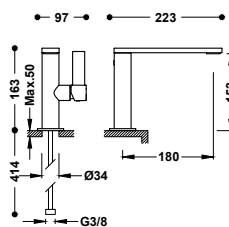

Grifo monomando con maneta lateral para lavabo
 Latiguillos de alimentación flexibles G3/8.

- 21120501
- 21120501NM
- 21120501BM
- 21120501AC
- 21120501KM
- 21120501KMB
- 21120501OR
- 21120501OM
- 21120501OP
- 21120501OPM



N

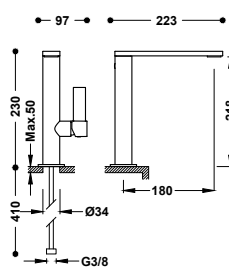

Grifo monomando alto con maneta lateral para lavabo
 Latiguillos de alimentación flexibles G3/8.

- 21130501
- 21130501NM
- 21130501BM
- 21130501AC
- 21130501KM
- 21130501KMB
- 21130501OR
- 21130501OM
- 21130501OP
- 21130501OPM



N

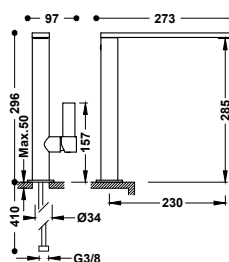

Grifo monomando XXL con maneta lateral para lavabo
 Latiguillos de alimentación flexibles G3/8.

- 21140501
- 21140501NM
- 21140501BM
- 21140501AC
- 21140501KM
- 21140501KMB
- 21140501OR
- 21140501OM
- 21140501OP
- 21140501OPM



N

Grifo de 1 agua para lavabo
Con latiguillo de alimentación flexible G3/8.

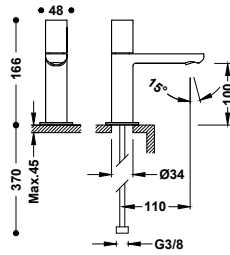

- 21150301
- 21150301NM
- 21150301BM
- 21150301AC
- 21150301KM
- 21150301KMB
- 21150301OR
- 21150301OM
- 21150301OP
- 21150301OPM

N

Grifo monomando empotrado para lavabo
Cuerpo empotrado indivisible con amortiguadores acústicos. Junta antihumedad. Caño de 180 mm.

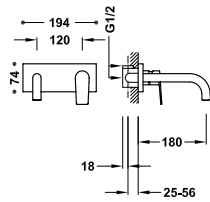

- 21130011
- 21130011NM
- 21130011BM
- 21130011AC
- 21130011KM
- 21130011KMB
- 21130011OR
- 21130011OM
- 21130011OP
- 21130011OPM

N

Grifo monomando empotrado para lavabo
Cuerpo empotrado indivisible con amortiguadores acústicos. Junta antihumedad. Caño de 240 mm.

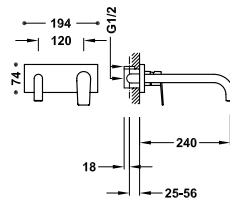

- 21130012
- 21130012NM
- 21130012BM
- 21130012AC
- 21130012KM
- 21130012KMB
- 21130012OR
- 21130012OM
- 21130012OP
- 21130012OPM

N

Grifo monomando empotrado para lavabo
Cuerpo empotrado indivisible con amortiguadores acústicos. Junta antihumedad. Caño de 180 mm.

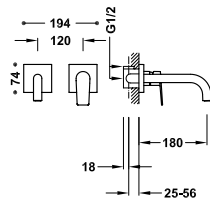

- 21130001
- 21130001NM
- 21130001BM
- 21130001AC
- 21130001KM
- 21130001KMB
- 21130001OR
- 21130001OM
- 21130001OP
- 21130001OPM

Grifo monomando empotrado para lavabo

Cuerpo empotrado indivisible con amortiguadores acústicos. Junta antihumedad. Caño de 240 mm.

■ 21130002

- 21130002NM
- 21130002BM
- 21130002AC
- 21130002KM
- 21130002KMB
- 21130002OR
- 21130002OM
- 21130002OP
- 21130002OPM

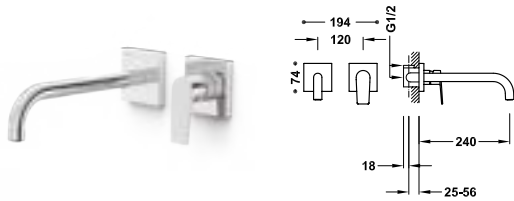

GRIFOS PARA BIDÉ

Grifo monomando para bidé

Rótula orientable. Latiguillos de alimentación flexibles G3/8.

■ 21112002
■ 21112002D

- 21112002NM
- 21112002BM
- 21112002AC
- 21112002KM
- 21112002KMB
- 21112002OR
- 21112002OM
- 21112002OP
- 21112002OPM

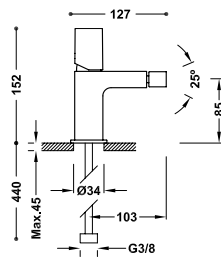

Grifo monomando para bidé

Rótula orientable. Latiguillos de alimentación flexibles G3/8.

■ 21112001
■ 21112001D

- 21112001NM
- 21112001BM
- 21112001AC
- 21112001KM
- 21112001KMB
- 21112001OR
- 21112001OM
- 21112001OP
- 21112001OPM

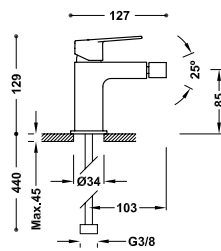

Grifo monomando con maneta lateral para bidé

Rótula orientable. Latiguillos de alimentación flexibles G3/8.

■ 21122401

- 21122401NM
- 21122401BM
- 21122401AC
- 21122401KM
- 21122401KMB
- 21122401OR
- 21122401OM
- 21122401OP
- 21122401OPM

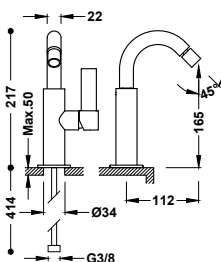

GRIFOS MURALES

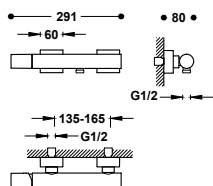

Grifo monomando mural para ducha

Ducha de mano anticalcárea de latón. Soporte orientable para ducha de mano. Flexo satinado.

- 21116701
- 21116701NM
- 21116701BM
- 21116701AC
- 21116701KM
- 21116701KMB
- 21116701OR
- 21116701OM
- 21116701OP
- 21116701OPM

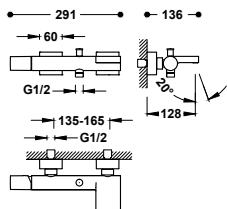

Grifo monomando mural para bañera y ducha

Con salida de agua en cascada. Ducha de mano anticalcárea de latón. Soporte orientable para ducha de mano. Flexo satinado.

- 21117001
- 21117001NM
- 21117001BM
- 21117001AC
- 21117001KM
- 21117001KMB
- 21117001OR
- 21117001OM
- 21117001OP
- 21117001OPM



GRIFOS EMPOTRADOS RAPID-BOX

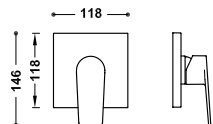

Pieza vista para caja empotrada de 1 vía Rapid-box

Sólo parte vista. Incluye placa embellecedora, mando, casquillo y tornillo de fijación oculto. Caja empotrada no incluida.

- 21127810
- 21127810NM
- 21127810BM
- 21127810AC
- 21127810KM
- 21127810KMB
- 21127810OR
- 21127810OM
- 21127810OP
- 21127810OPM



Caja empotrada de 1 vía Rapid-box con grifo monomando para ducha









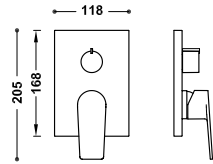

20827810



Pieza vista para caja empotrada de 2 vías Rapid-box

Sólo parte vista. Incluye placa embellecedora, mando, volante distribuidor y tornillo de fijación oculto. **Caja empotrada no incluida.**



-  21128110
-  21128110NM
-  21128110BM
-  21128110AC
-  21128110KM
-  21128110KMB
-  21128110OR
-  21128110OM
-  21128110OP
-  21128110OPM





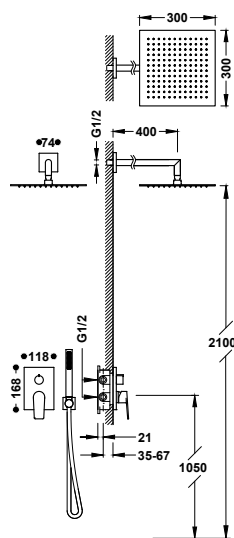





Caja empotrada de 2 vías Rapid-box con grifo monomando para ducha y bañera

20828110



Kit de grifo monomando empotrado de 2 vías Rapid-box para ducha





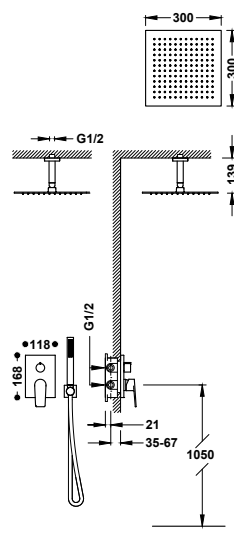





- Cuerpo empotrado incluido.
- Distribuidor cerámico de 2 vías.
- Brazo a pared con rociador de ducha orientable y de acero inoxidable: 300x300 mm.
- Soporte para ducha de mano con toma de agua a pared.
- Ducha de mano anticalcárea de latón.
- Flexo satinado.

-  21128004
-  21128004NM
-  21128004BM
-  21128004AC
-  21128004KM
-  21128004KMB
-  21128004OR
-  21128004OM
-  21128004OP
-  21128004OPM



Kit de grifo monomando empotrado de 2 vías Rapid-box para ducha

- Cuerpo empotrado incluido.
- Distribuidor cerámico de 2 vías.
- Brazo a techo con rociador de ducha orientable y de acero inoxidable: 300x300 mm.
- Soporte para ducha de mano con toma de agua a pared.
- Ducha de mano anticalcárea de latón.
- Flexo satinado.

-  21128003
-  21128003NM
-  21128003BM
-  21128003AC
-  21128003KM
-  21128003KMB
-  21128003OR
-  21128003OM
-  21128003OP
-  21128003OPM



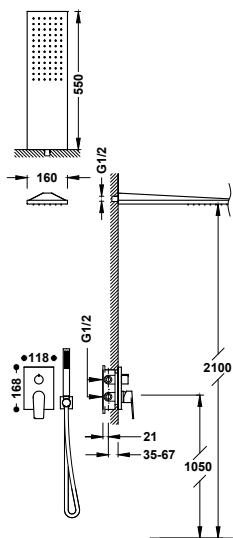

Kit de grifo monomando empotrado de 2 vías Rapid-box para ducha

- Cuerpo empotrado incluido.
- Distribuidor cerámico de 2 vías.
- Rociador de ducha a pared de acero inoxidable: 160x550 mm.
- Soporte para ducha de mano con toma de agua a pared.
- Ducha de mano anticalcárea de latón.
- Flexo satinado.

- 21128005
- 21128005NM
- 21128005BM
- 21128005AC
- 21128005KM
- 21128005KMB
- 21128005OR
- 21128005OM
- 21128005OP
- 21128005OPM



N

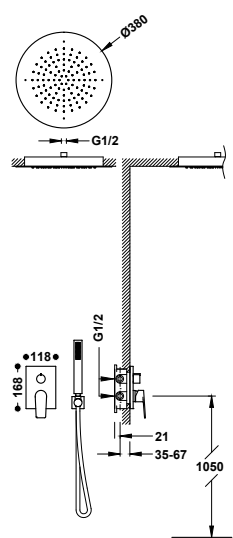

Kit de grifo monomando empotrado de 2 vías Rapid-box para ducha

- Cuerpo empotrado incluido.
- Distribuidor cerámico de 2 vías.
- Rociador de ducha empotrado a techo de acero inoxidable: Ø 380 mm.
- Soporte para ducha de mano con toma de agua a pared.
- Ducha de mano anticalcárea de latón.
- Flexo satinado.

- 21128006
- 21128006NM
- 21128006BM
- 21128006AC
- 21128006KM
- 21128006KMB
- 21128006OR
- 21128006OM
- 21128006OP
- 21128006OPM



N

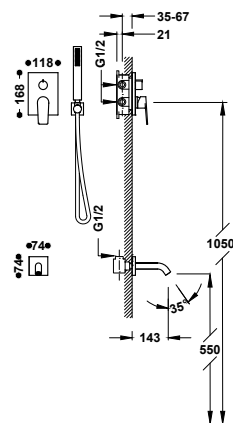

Kit de grifo monomando empotrado de 2 vías Rapid-box para bañera y ducha

- Cuerpo empotrado incluido.
- Distribuidor cerámico de 2 vías.
- Caño fijo de bañera a pared.
- Soporte para ducha de mano con toma de agua a pared.
- Ducha de mano anticalcárea de latón.
- Flexo satinado.

- 21128007
- 21128007NM
- 21128007BM
- 21128007AC
- 21128007KM
- 21128007KMB
- 21128007OR
- 21128007OM
- 21128007OP
- 21128007OPM



N

GRIFOS PARA BAÑERA

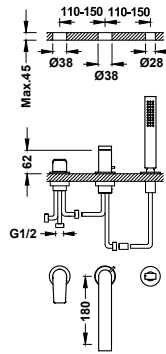

Grifo monomando para borde de bañera

- Inversor integrado en el caño de bañera.
- Ducha de mano anticalcárea de latón.
- Caño de bañera de 180 mm. Caudal: 3 bar - 13 l/min.
- Kit depósito opcional no incluido ref.: 20024501.

- 21116101
- 21116101NM
- 21116101BM
- 21116101AC
- 21116101KM
- 21116101KMB
- 21116101OR
- 21116101OM
- 21116101OP
- 21116101OPM



N



Depósito para grifería de borde de bañera

- 20024501

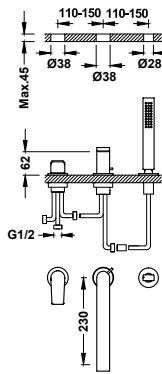

Grifo monomando para borde de bañera

- Inversor integrado en el caño de bañera.
- Ducha de mano anticalcárea de latón.
- Caño de bañera de 230 mm. Caudal: 3 bar - 13 l/min.
- Kit depósito opcional no incluido ref.: 20024501.

- 21116103
- 21116103NM
- 21116103BM
- 21116103AC
- 21116103KM
- 21116103KMB
- 21116103OR
- 21116103OM
- 21116103OP
- 21116103OPM



N



Depósito para grifería de borde de bañera

- 20024501

GRIFOS TERMOSTÁTICOS MURALES

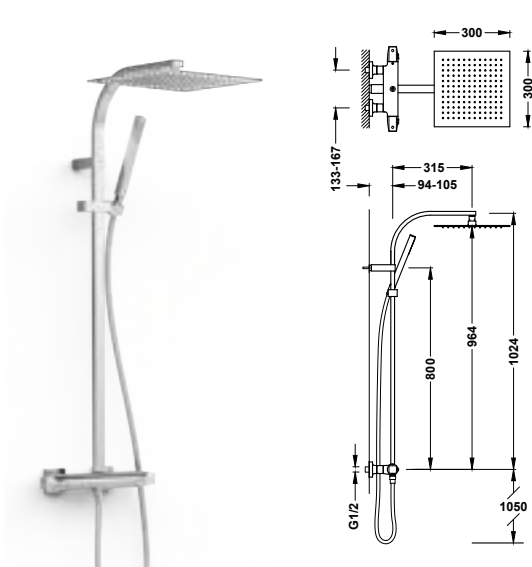

Conjunto de grifo termostático mural Over-wall de 2 vías para ducha

- Con inversor integrado en el regulador de caudal.
- Volante cuadrado-redondo.
- Rociador de ducha orientable de acero inoxidable: 300x300 mm.
- Soporte deslizante y orientable para ducha de mano.
- Ducha de mano anticalcárea de latón.
- Flexo satinado.

- 19039305
- 19039305NM
- 19039305BM
- 19039305AC
- 19039305KMB
- 19039305OM
- 19039305OPM

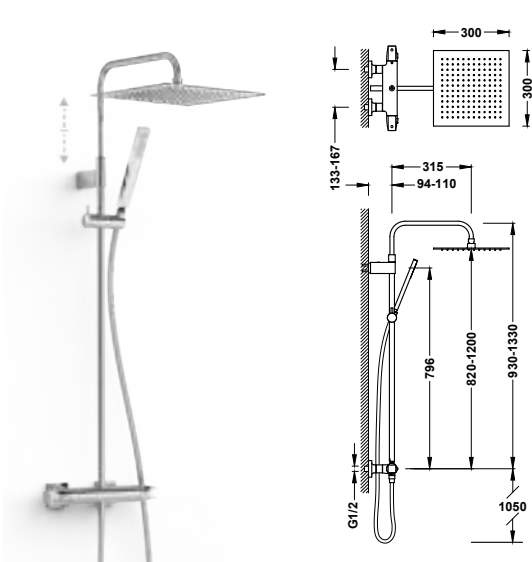

Conjunto de grifo termostático mural Over-wall de 2 vías para ducha

- Con inversor integrado en el regulador de caudal.
- Volante cuadrado-redondo.
- Barra de ducha telescópica.
- Rociador de ducha orientable de acero inoxidable: 300x300 mm.
- Soporte deslizante y orientable para ducha de mano.
- Ducha de mano anticalcárea de latón.
- Flexo satinado.

- 19039307
- 19039307NM
- 19039307BM
- 19039307AC
- 19039307KMB
- 19039307OM
- 19039307OPM



GRIFOS TERMOSTÁTICOS EMPOTRADOS

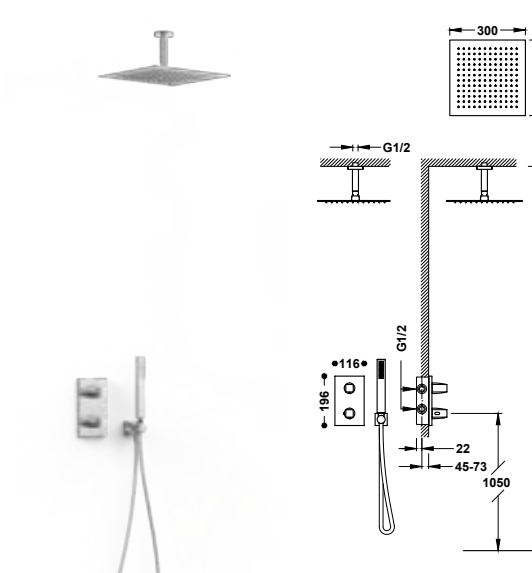

Kit de grifo termostático empotrado de 2 vías Therm-box para ducha

- Cuerpo empotrado incluido.
- Volante cuadrado-redondo con control de temperatura. Distribuidor cerámico de 2 vías.
- Brazo a techo con rociador de ducha orientable y de acero inoxidable: 300x300 mm.
- Soporte para ducha de mano con toma de agua a pared.
- Ducha de mano anticalcárea de latón.
- Flexo satinado.

- 21125003
- 21125003NM
- 21125003BM
- 21125003AC
- 21125003KMB
- 21125003OR
- 21125003OM
- 21125003OP
- 21125003OPM

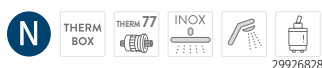

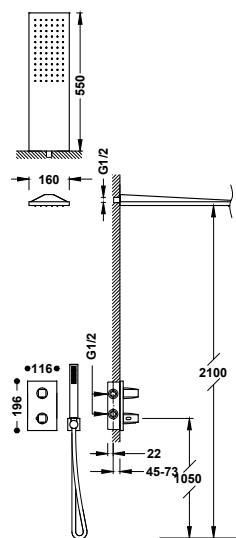

Kit de grifo termostático empotrado de 2 vías Therm-box para ducha

- Cuerpo empotrado incluido.
- Volante cuadrado-redondo con control de temperatura. Distribuidor cerámico de 2 vías.
- Rociador de ducha a pared de acero inoxidable: 160x550 mm.
- Soporte para ducha de mano con toma de agua a pared.
- Ducha de mano anticalcárea de latón.
- Flexo satinado.

-  21125005
-  21125005NM
-  21125005BM
-  21125005AC
-  21125005KM
-  21125005KMB
-  21125005OR
-  21125005OM
-  21125005OP
-  21125005OPM

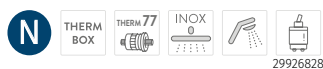

MAX

El cuidado estético junto con toda la tecnología desarrollada para su creación sitúan Max entre las series más elegantes y funcionales que aportan modernidad, sencillez y calidad al baño.

Acabados disponibles:



CR







GRIFOS PARA LAVABO

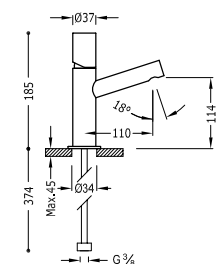

Grifo monomando para lavabo
Latiguillos de alimentación flexibles G3/8.

- 06110301
- 06110301D

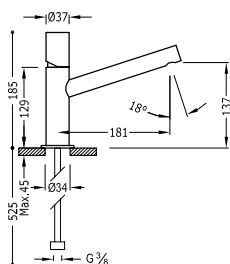

Grifo monomando para lavabo
Caño largo. Latiguillos de alimentación flexibles G3/8.

- 06120301
- 06120301D

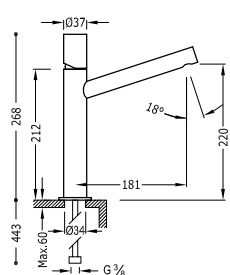

Grifo monomando alto para lavabo
Caño largo. Latiguillos de alimentación flexibles G3/8.

- 06120601

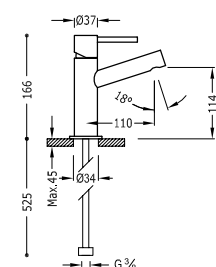

Grifo monomando para lavabo
Latiguillos de alimentación flexibles G3/8.

- 06210301
- 06210301D

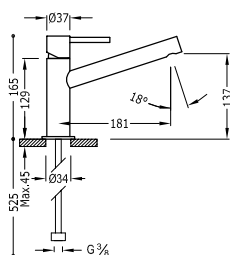

Grifo monomando para lavabo
Caño largo. Latiguillos de alimentación flexibles G3/8.

- 06220301
- 06220301D



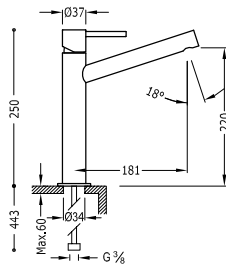

Grifo monomando alto para lavabo

Caño largo. Latiguillos de alimentación flexibles G3/8.

06220601

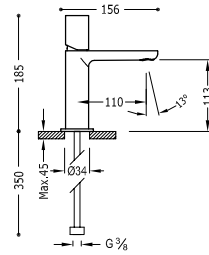

Grifo monomando para lavabo

Latiguillos de alimentación flexibles G3/8.

06110302
06110302D

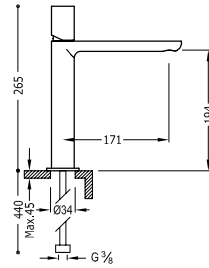

Grifo monomando alto para lavabo

Latiguillos de alimentación flexibles G3/8.

06120304

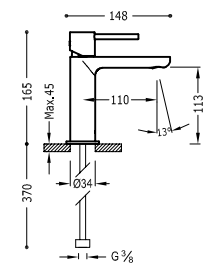

Grifo monomando para lavabo

Latiguillos de alimentación flexibles G3/8.

06210302
06210302D

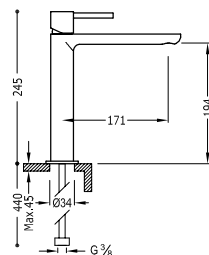

Grifo monomando alto para lavabo

Latiguillos de alimentación flexibles G3/8.

06220304



TOUCH-TRES

EL GRIFO ELECTRÓNICO SENSIBLE AL TACTO

Se cierra automáticamente a los 10 segundos o bien cuando se vuelve a tocar.

SÓLO TOCAR
(NO PULSAR)



Grifo electrónico de 1 agua para lavabo
Sistema sensible al tacto TOUCH-TRES.

06144701

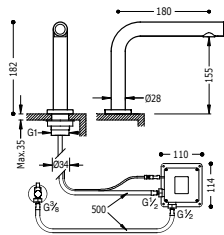

Grifo electrónico con sistema premezclador para lavabo
Sistema sensible al tacto TOUCH-TRES. Incluye una válvula mezcladora de 2 aguas con tubos flexibles (ref.: 19250730).

06144801

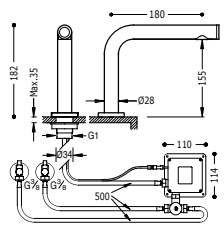

Grifo de 1 agua para lavabo
Con latiguillo de alimentación flexible G3/8.

20050301

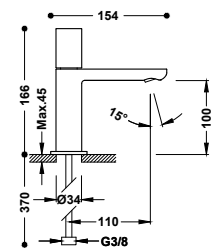

9134282

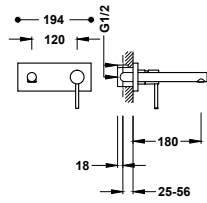

Grifo monomando empotrado para lavabo

Cuerpo empotrado indivisible con amortiguadores acústicos. Junta antihumedad. Caño de 180 mm.

06230011

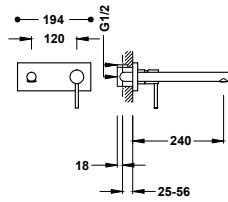

Grifo monomando empotrado para lavabo

Cuerpo empotrado indivisible con amortiguadores acústicos. Junta antihumedad. Caño de 240 mm.

06230012

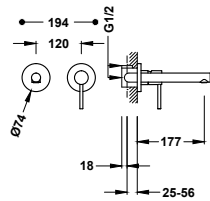

Grifo monomando empotrado para lavabo

Cuerpo empotrado indivisible con amortiguadores acústicos. Junta antihumedad. Caño de 177 mm.

06230001

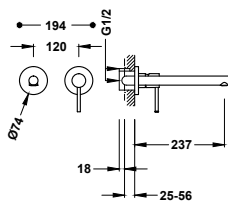

Grifo monomando empotrado para lavabo

Cuerpo empotrado indivisible con amortiguadores acústicos. Junta antihumedad. Caño de 237 mm.

06230002

GRIFOS PARA BIDÉ

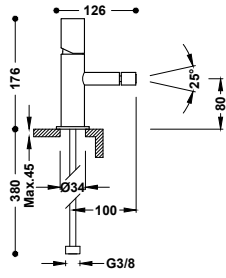

Grifo monomando para bidé
Rótula orientable. Latiguillos de alimentación flexibles G3/8.

- 06112001
- 06112001D



910719005

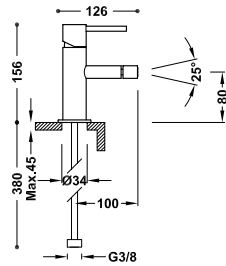

Grifo monomando para bidé
Rótula orientable. Latiguillos de alimentación flexibles G3/8.

- 06212001
- 06212001D



910719005

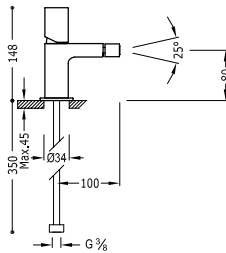

Grifo monomando para bidé
Rótula orientable. Latiguillos de alimentación flexibles G3/8.

- 06122001
- 06122001D



9130190

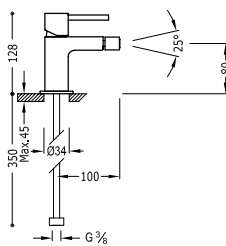

Grifo monomando para bidé
Rótula orientable. Latiguillos de alimentación flexibles G3/8.

- 06222001
- 06222001D



9130190

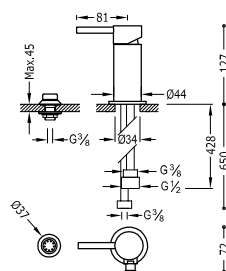

Grifo monomando para bidé con transferencia a duchita
Con inversor para duchita. Latiguillos de alimentación flexibles G3/8.

- 06213001



9134592

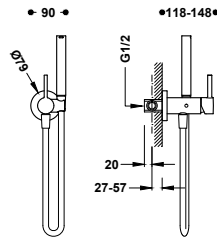

Grifo monomando empotrado con ducha para inodoro

Con agua fría o caliente. Ducha de mano con racor limitador a 5 l/min. y sistema antigoteo. Soporte fijo para la ducha de mano instalable a derecha o izquierda. Flexo satinado.

134123

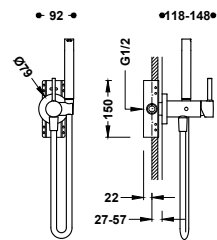

Grifo monomando empotrado con ducha para inodoro

Opción para paredes de Pladur. Con agua fría o caliente. Ducha de mano con racor limitador a 5 l/min. y sistema antigoteo. Soporte fijo para la ducha de mano instalable a derecha o izquierda. Flexo satinado.

134122



Accesorio porta toallas para grifo con ducha para inodoro

Soporte instalable a derecha o izquierda (para ref.: 134122, 134123, 181122, 181123, 181222, 181223, 20522201, 20522301). Long: 180 mm.

03412401

GRIFOS MURALES

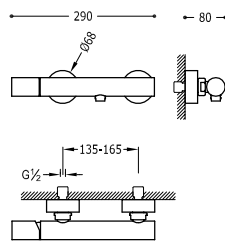

Grifo monomando mural para ducha

Ducha de mano anticalcárea. Soporte orientable para ducha de mano. Flexo satinado.

06116701

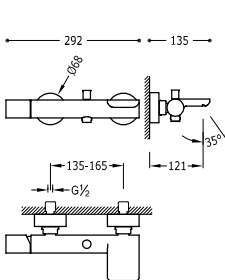

Grifo monomando mural para bañera y ducha

Ducha de mano anticalcárea. Caño cerrado con salida del agua en cascada. Soporte orientable para ducha de mano. Flexo satinado.

06117001



GRIFOS EMPOTRADOS RAPID-BOX

Pieza vista para caja empotrada de 1 vía Rapid-box

06227810

Sólo parte vista. Incluye placa embellecedora, mando, casquillo y tornillo de fijación oculto. **Caja empotrada no incluida.**

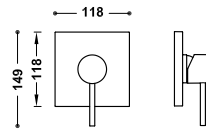

Caja empotrada de 1 vía Rapid-box con grifo monomando para ducha

20827810

N

Pieza vista para caja empotrada de 2 vías Rapid-box

06228110

Sólo parte vista. Incluye placa embellecedora, mando, volante distribuidor y tornillo de fijación oculto. **Caja empotrada no incluida.**

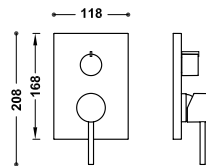

Caja empotrada de 2 vías Rapid-box con grifo monomando para ducha y bañera

20828110

N

Kit de grifo monomando empotrado de 2 vías Rapid-box para ducha

06228004

- Cuerpo empotrado incluido.
- Distribuidor cerámico de 2 vías.
- Brazo a pared con rociador de ducha orientable y de acero inoxidable: Ø 250 mm.
- Soporte para ducha de mano con toma de agua a pared.
- Ducha de mano anticalcárea de latón.
- Flexo satinado.

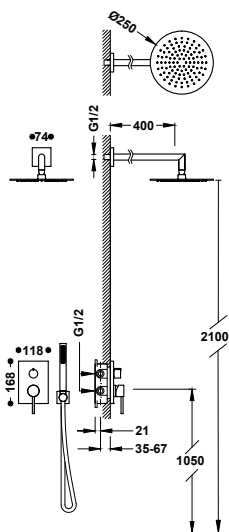

29903508

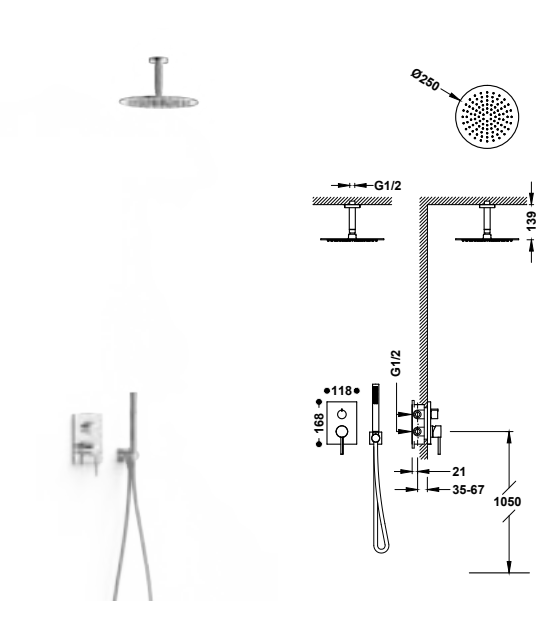

Kit de grifo monomando empotrado de 2 vías Rapid-box para ducha

06228003

- Cuerpo empotrado incluido.
- Distribuidor cerámico de 2 vías.
- Brazo a techo con rociador de ducha orientable y de acero inoxidable: Ø 250 mm.
- Soporte para ducha de mano con toma de agua a pared.
- Ducha de mano anticalcárea de latón.
- Flexo satinado.

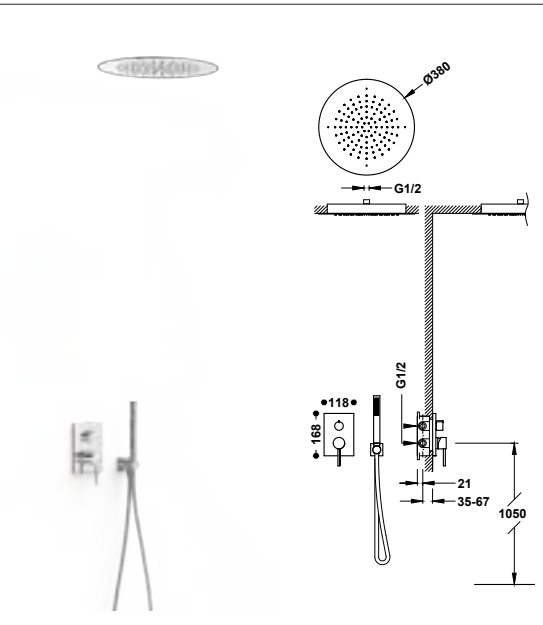

Kit de grifo monomando empotrado de 2 vías Rapid-box para ducha

06228005

- Cuerpo empotrado incluido.
- Distribuidor cerámico de 2 vías.
- Rociador empotrado a techo de acero inoxidable: Ø 380 mm.
- Soporte para ducha de mano con toma de agua a pared.
- Ducha de mano anticalcárea de latón.
- Flexo satinado.

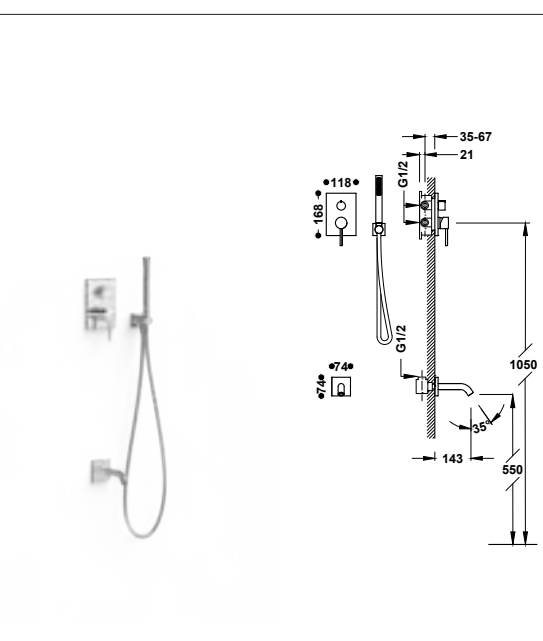

Kit de grifo monomando empotrado de 2 vías Rapid-box para bañera y ducha

06228006

- Cuerpo empotrado incluido.
- Distribuidor cerámico de 2 vías.
- Caño fijo de bañera a pared.
- Soporte para ducha de mano con toma de agua a pared.
- Ducha de mano anticalcárea de latón.
- Flexo satinado.



GRIFOS EMPOTRADOS

Grifo monomando empotrado de 1 vía para ducha

06217702

Cuerpo empotrado incluido.

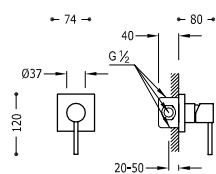
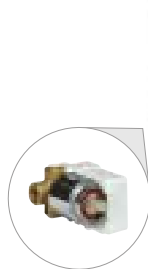

9130190

Grifo monomando empotrado de 2 vías para bañera y ducha

06218002

Cuerpo empotrado incluido. Inversor de 2 vías.

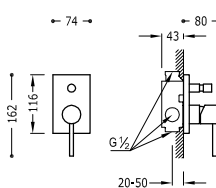

9130190

Kit de grifo monomando empotrado de 2 vías para ducha

06298004

- Cuerpo empotrado incluido.
- Inversor de 2 vías.
- Brazo a pared con rociador de ducha orientable y de acero inoxidable: Ø 250 mm.
- Soporte para ducha de mano con toma de agua a pared.
- Ducha de mano anticalcárea.
- Flexo satinado.

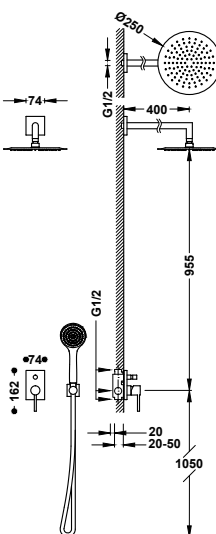

9130190

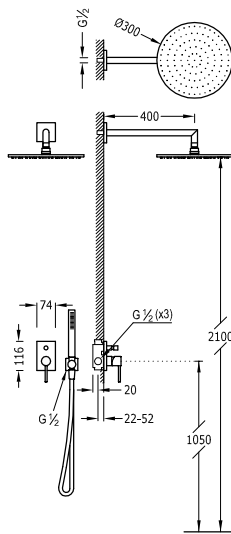

Kit de grifo monomando empotrado de 2 vías para ducha

06298001

- Cuerpo empotrado incluido.
- Inversor de 2 vías.
- Brazo a pared con rociador de ducha orientable y de acero inoxidable: Ø 300 mm.
- Soporte para ducha de mano con toma de agua a pared.
- Ducha de mano anticalcárea de latón.
- Flexo satinado.



9130190

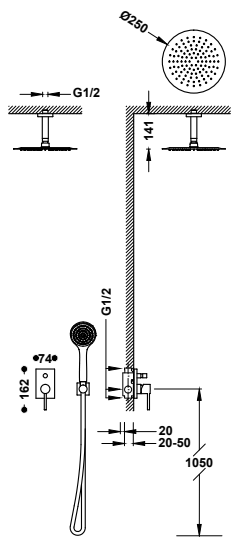

Kit de grifo monomando empotrado de 2 vías para ducha

06218081

- Cuerpo empotrado incluido.
- Inversor de 2 vías.
- Brazo a techo con rociador de ducha orientable y de acero inoxidable: Ø 250 mm.
- Soporte para ducha de mano con toma de agua a pared.
- Ducha de mano anticalcárea.
- Flexo satinado.



9130190

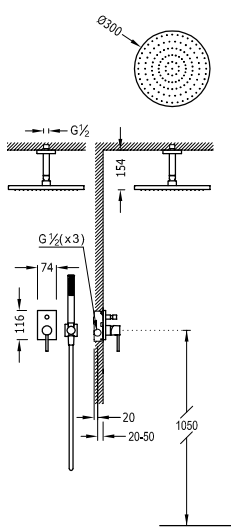

Kit de grifo monomando empotrado de 2 vías para ducha

06218080

- Cuerpo empotrado incluido.
- Inversor de 2 vías.
- Brazo a techo con rociador de ducha orientable y de acero inoxidable: Ø 300 mm.
- Soporte para ducha de mano con toma de agua a pared.
- Ducha de mano anticalcárea de latón.
- Flexo satinado.



9130190

GRIFOS PARA BAÑERA

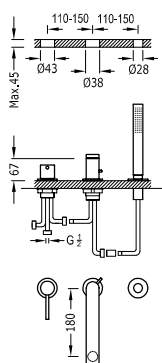

Grifo monomando para borde de bañera

06216103

- Inversor integrado en el caño de bañera.
- Ducha de mano anticalcárea de latón.
- Caño de bañera de 180 mm. Caudal: 3 bar - 16 l/m.
- Kit depósito opcional no incluido ref.: 20324501.



Depósito para grifería de borde de bañera

20324501

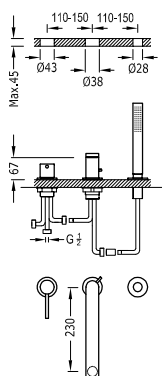

Grifo monomando para borde de bañera

06216102

- Inversor integrado en el caño de bañera.
- Ducha de mano anticalcárea de latón.
- Caño de bañera de 230 mm. Caudal: 3 bar - 16 l/m.
- Kit depósito opcional no incluido ref.: 20324501.



Depósito para grifería de borde de bañera

20324501

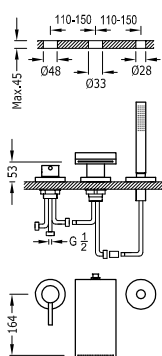

Grifo monomando para borde de bañera

162161

- Inversor integrado en el caño de bañera.
- Ducha de mano anticalcárea de latón.
- Caño de bañera con salida del agua en cascada. Caudal: 3 bar - 17 l/m.
- Kit depósito opcional no incluido ref.: 162245.

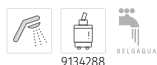

Depósito para grifería de borde de bañera

162245

GRIFOS TERMOSTÁTICOS MURALES

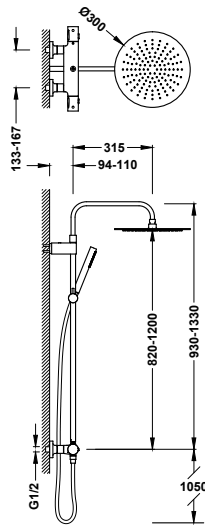

Conjunto de grifo termostático mural Over-wall de 2 vías para ducha

19039302

- Con inversor integrado en el regulador de caudal.
- Volante redondo.
- Barra de ducha telescópica.
- Rociador de ducha orientable de acero inoxidable: Ø 300 mm.
- Soporte deslizante y orientable para ducha de mano.
- Ducha de mano anticalcárea de latón.
- Flexo satinado.

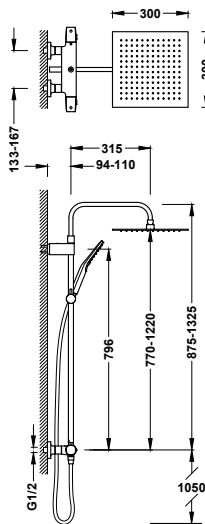

Conjunto de grifo termostático mural Over-wall de 2 vías para ducha

19038702

- Con inversor integrado en el regulador de caudal.
- Volante con bordes redondeados.
- Barra de ducha telescópica.
- Rociador de ducha orientable de acero inoxidable: 300x300 mm.
- Soporte deslizante y orientable para ducha de mano.
- Ducha de mano anticalcárea: 96x110 mm. (3 tipos de chorro).
- Flexo satinado.



GRIFOS TERMOSTÁTICOS EMPOTRADOS

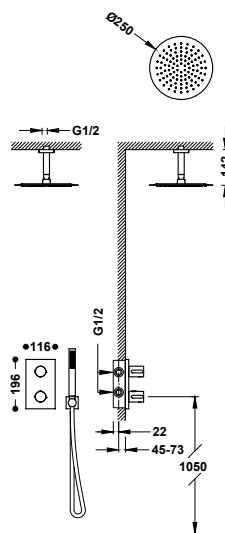

Kit de grifo termostático empotrado de 2 vías Therm-box para ducha

06225003

- Cuerpo empotrado incluido.
- Volante redondo con control de temperatura. Distribuidor cerámico de 2 vías.
- Brazo a techo con rociador de ducha orientable y de acero inoxidable: Ø 250 mm.
- Soporte para ducha de mano con toma de agua a pared.
- Ducha de mano anticalcárea de latón.
- Flexo satinado.

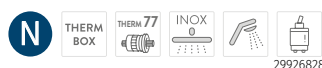

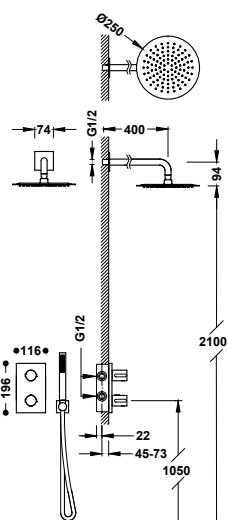

Kit de grifo termostático empotrado de 2 vías Therm-box para ducha

06225004

- Cuerpo empotrado incluido.
- Volante redondo con control de temperatura. Distribuidor cerámico de 2 vías.
- Brazo a pared con rociador de ducha orientable y de acero inoxidable: Ø 250 mm.
- Soporte para ducha de mano con toma de agua a pared.
- Ducha de mano anticalcárea de latón.
- Flexo satinado.



LLAVES DE PASO

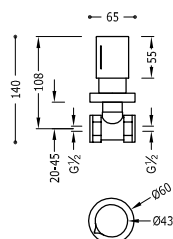

Llave de paso empotrada
Conexión a rosca hembra: 1/2".

06115501

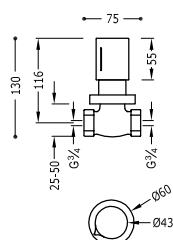

Llave de paso empotrada
Conexión a rosca hembra: 3/4".

06151101

LEX-ALP

Un diseño clásico que invita a la calma. Lex-Alp es una serie equilibrada, que funciona a la perfección y nunca pasa de moda. Eso es lo que la hace más especial.

Acabados disponibles:



CR







GRIFOS PARA LAVABO

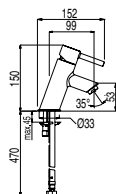

Grifo monomando inclinado para lavabo
 Latiguillos de alimentación flexibles G3/8.

- 20310301
- 20310301D

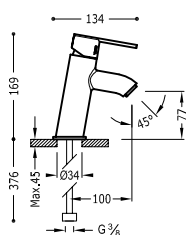

Grifo monomando inclinado para lavabo
 Con aireador de fácil limpieza. Latiguillos de alimentación flexibles G3/8.

- 181903

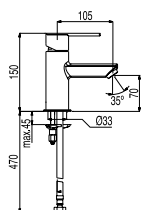

Grifo monomando para lavabo
 Con aireador de fácil limpieza. Latiguillos de alimentación flexibles G3/8.

- 181103
- 186103

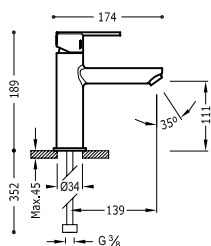

Grifo monomando para lavabo
 Con aireador de fácil limpieza. Latiguillos de alimentación flexibles G3/8.

- 181203
- 186203

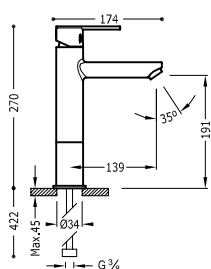

Grifo monomando alto para lavabo
 Con aireador de fácil limpieza. Latiguillos de alimentación flexibles G3/8.

- 181217
- 186217



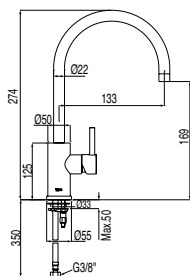

Grifo monomando con maneta lateral para lavabo
Latiguillos de alimentación flexibles G3/8.

20370301



9134592

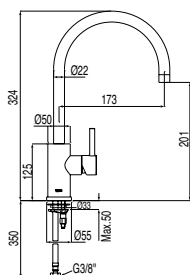

Grifo monomando alto con maneta lateral para lavabo
Latiguillos de alimentación flexibles G3/8.

20340301



9134592

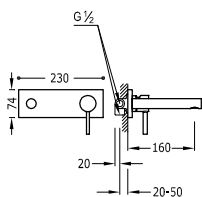

Grifo monomando empotrado para lavabo
Cuerpo empotrado incluido e indivisible. Caño de 160 mm.

20321001



9134592

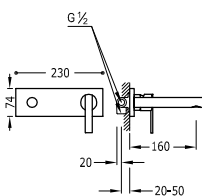

Grifo monomando empotrado para lavabo
Cuerpo empotrado incluido e indivisible. Caño de 160 mm.

08120001



9134592

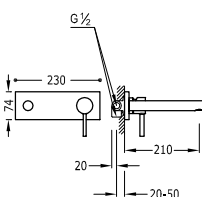

Grifo monomando empotrado para lavabo
Cuerpo empotrado incluido e indivisible. Caño de 210 mm.

20320002



9134592



Grifo monomando empotrado para lavabo

Cuerpo empotrado incluido e indivisible. Caño de 210 mm.

08120021

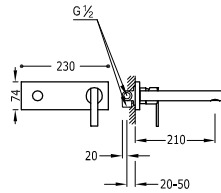

9134592

GRIFOS PARA BIDÉ

Grifo monomando para bidé

Rótula orientable. Con aireador de fácil limpieza. Latiguillos de alimentación flexibles G3/8.

181120

186120

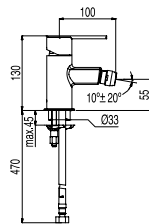

9134592



IA

Grifo monomando inclinado para bidé

Rótula orientable. Latiguillos de alimentación flexibles G3/8.

20312001

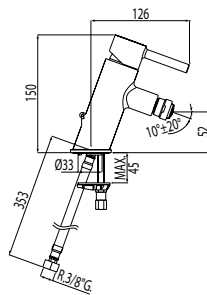

9134592



IB

Grifo monomando inclinado para bidé

Rótula orientable. Con aireador de fácil limpieza. Latiguillos de alimentación flexibles G3/8.

181920

186920

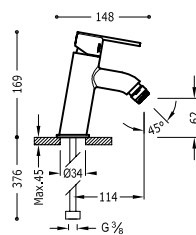

9134592

Grifo monomando con maneta lateral para bidé

Rótula orientable. Latiguillos de alimentación flexibles G3/8.

20322401

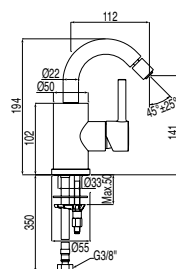

9134592



360°

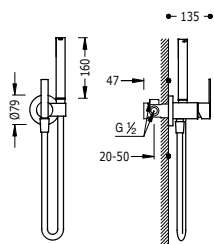

Grifo monomando empotrado con ducha para inodoro
 Con agua fría o caliente. Ducha de mano con racor limitador a 5 l/min. y sistema antigoteo. Soporte fijo para la ducha de mano instalable a derecha o izquierda. Flexo satinado.

181223

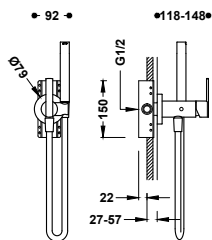

Grifo monomando empotrado con ducha para inodoro
 Opción para paredes de Pladur. Con agua fría o caliente. Ducha de mano con racor limitador a 5 l/min. y sistema antigoteo. Soporte fijo para la ducha de mano instalable a derecha o izquierda. Flexo satinado.

181222



Accesorio porta toallas para grifo con ducha para inodoro
 Soporte instalable a derecha o izquierda (para ref.: 134122, 134123, 181122, 181123, 181222, 181223, 20522201, 20522301). Long: 180 mm.

03412401

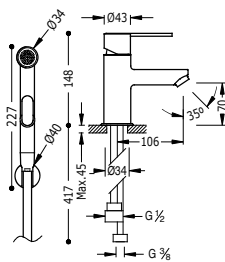

Grifo monomando para lavabo con ducha para inodoro
 Ducha de mano anticalcárea con cierre de caudal. Soporte fijo para ducha de mano. Flexo satinado. Latiguillos de alimentación flexibles G3/8.

181113

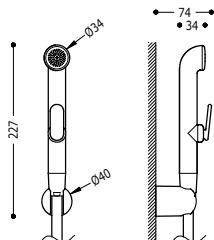

Kit de ducha para grifo monomando para inodoro
 Ducha de mano con cierre de caudal. Soporte fijo para ducha de mano. Flexo satinado. Atención: Recambio solo para bidé ref: 162113 y 181113.

29995001

GRIFOS MURALES

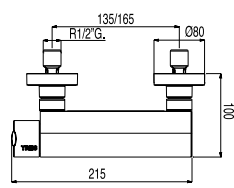

Grifo monomando mural para ducha

181468

Ducha de mano anticalcárea: Ø 100 mm. (5 tipos de chorro). Soporte orientable para ducha de mano. Flexo satinado.

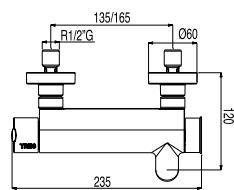

Grifo monomando mural para bañera y ducha

181474

Ducha de mano anticalcárea: Ø 100 mm. (5 tipos de chorro). Soporte orientable para ducha de mano. Flexo satinado.

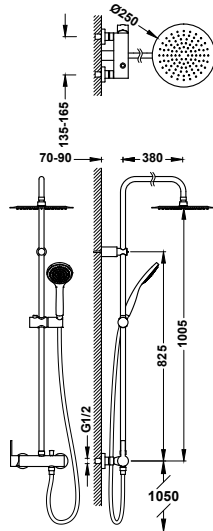

Conjunto de grifo monomando mural de 2 vías para ducha

18119102

- Rociador de ducha orientable de acero inoxidable: Ø 250 mm.
- Soporte deslizante y orientable para ducha de mano.
- Ducha de mano anticalcárea: Ø 100 mm.
- Flexo satinado.

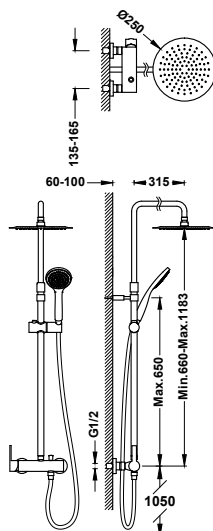

Conjunto de grifo monomando mural de 2 vías para ducha

08119703

- Rociador de ducha orientable de acero inoxidable: Ø 250 mm.
- Barra de ducha telescópica.
- Soporte deslizante y orientable para ducha de mano.
- Ducha de mano anticalcárea: Ø 100 mm.
- Flexo satinado.



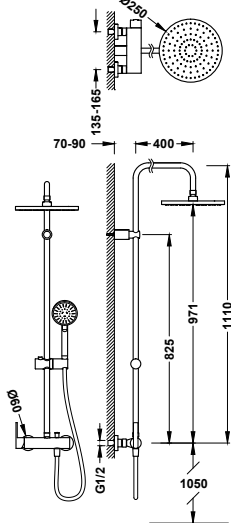

Conjunto de grifo monomando mural de 2 vías para ducha

181191

- Rociador de ducha orientable de acero inoxidable: Ø 250 mm.
- Soporte deslizante y orientable para ducha de mano.
- Ducha de mano anticalcárea: Ø 100 mm. (5 tipos de chorro).
- Flexo satinado.

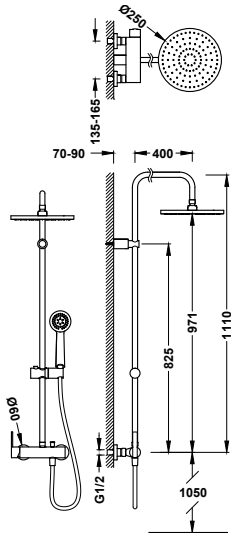

Conjunto de grifo monomando mural de 2 vías para ducha

081192

- Rociador de ducha orientable de acero inoxidable: Ø 250 mm.
- Soporte deslizante y orientable para ducha de mano.
- Ducha de mano anticalcárea: Ø 100 mm.
- Flexo metálico reforzado.

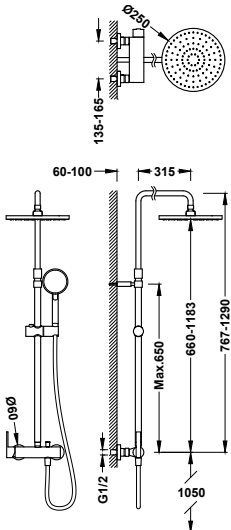

Conjunto de grifo monomando mural de 2 vías para ducha

0811902

- Rociador de ducha orientable de acero inoxidable: Ø 250 mm.
- Barra de ducha telescópica.
- Soporte deslizante y orientable para ducha de mano.
- Ducha de mano anticalcárea: Ø 100 mm. (5 tipos de chorro).
- Flexo satinado.



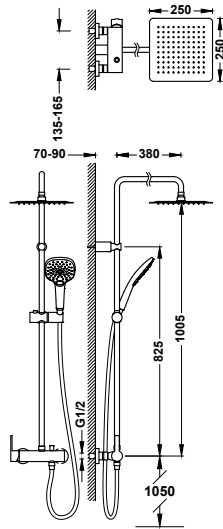

Conjunto de grifo monomando mural de 2 vías para ducha

08119302

- Rociador de ducha orientable de acero inoxidable: 250x250 mm.
- Soporte deslizante y orientable para ducha de mano.
- Ducha de mano anticalcárea: 120x120 mm. (3 tipos de chorro).
- Flexo satinado.

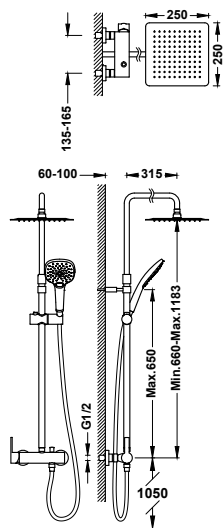

Conjunto de grifo monomando mural de 2 vías para ducha

08119704

- Rociador de ducha orientable de acero inoxidable: 250x250 mm.
- Barra de ducha telescópica.
- Soporte deslizante y orientable para ducha de mano.
- Ducha de mano anticalcárea: 120x120 mm. (3 tipos de chorro).
- Flexo satinado.

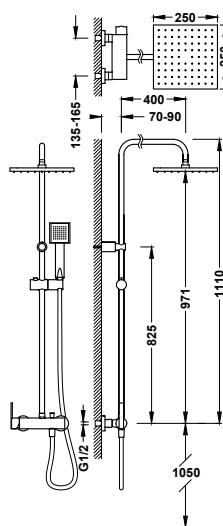

Conjunto de grifo monomando mural de 2 vías para ducha

08119301

- Rociador de ducha orientable de acero inoxidable: 250x250 mm.
- Soporte deslizante y orientable para ducha de mano.
- Ducha de mano anticalcárea: 80x80 mm.
- Flexo satinado.



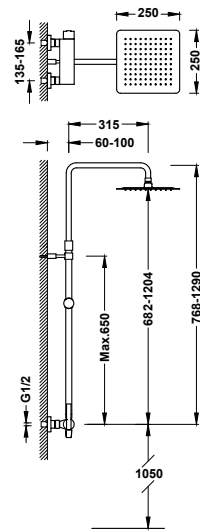

Conjunto de grifo monomando mural de 2 vías para ducha

08119701

- Rociador de ducha orientable de acero inoxidable: 250x250 mm.
- Barra de ducha telescópica.
- Soporte deslizante y orientable para ducha de mano.
- Ducha de mano anticalcárea.
- Flexo satinado.



GRIFOS EMPOTRADOS

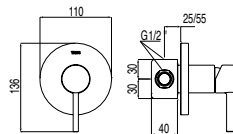

Grifo monomando empotrado de 1 vía para ducha

20317701

Cuerpo empotrado incluido.

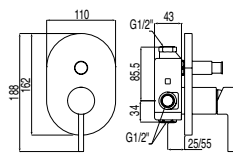

Grifo monomando empotrado de 2 vías para bañera y ducha

20318001

Cuerpo empotrado incluido. Inversor de 2 vías.

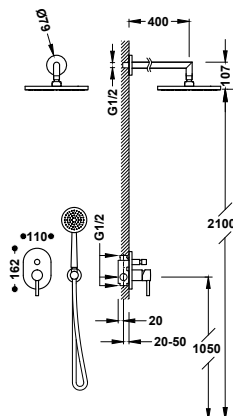
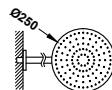

Kit de grifo monomando empotrado de 2 vías para ducha

20318002

- Cuerpo empotrado incluido.
- Inversor de 2 vías.
- Brazo a pared con rociador de ducha orientable y de acero inoxidable: Ø 250 mm.
- Soporte para ducha de mano con toma de agua a pared.
- Ducha de mano anticalcárea: Ø 100 mm.
- Flexo satinado.



GRIFOS PARA BAÑERA

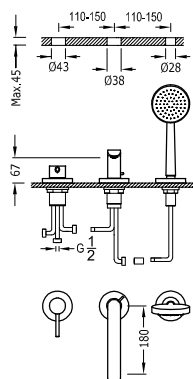

Grifo monomando para borde de bañera

20316102

- Inversor integrado en el caño de bañera.
- Ducha de mano anticalcárea: Ø 100 mm.
- Caño de bañera de 180 mm. Caudal: 3 bar - 16 l/m.
- Kit depósito opcional no incluido ref.: 20324501.



Depósito para grifería de borde de bañera

20324501

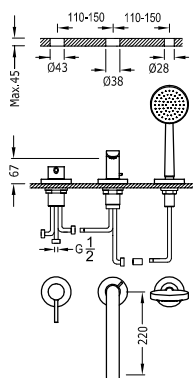

Grifo monomando para borde de bañera

20316101

- Inversor integrado en el caño de bañera.
- Ducha de mano anticalcárea: Ø 100 mm.
- Caño de bañera de 220 mm. Caudal: 3 bar - 16 l/m.
- Kit depósito opcional no incluido ref.: 20324501.



Depósito para grifería de borde de bañera

20324501

GRIFOS TERMOSTÁTICOS MURALES

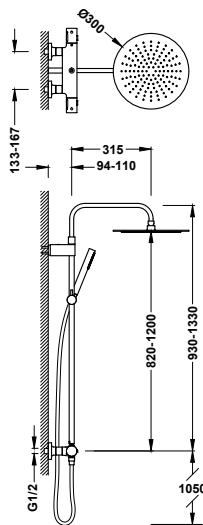

Conjunto de grifo termostático mural Over-wall de 2 vías para ducha

19039302

- Con inversor integrado en el regulador de caudal.
- Volante redondo.
- Barra de ducha telescópica.
- Rociador de ducha orientable de acero inoxidable: Ø 300 mm.
- Soporte deslizante y orientable para ducha de mano.
- Ducha de mano anticalcárea de latón.
- Flexo satinado.

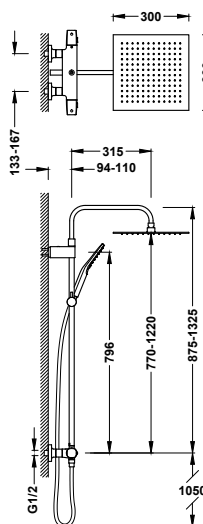

Conjunto de grifo termostático mural Over-wall de 2 vías para ducha

19038702

- Con inversor integrado en el regulador de caudal.
- Volante con bordes redondeados.
- Barra de ducha telescópica.
- Rociador de ducha orientable de acero inoxidable: 300x300 mm.
- Soporte deslizante y orientable para ducha de mano.
- Ducha de mano anticalcárea: 96x110 mm. (3 tipos de chorro).
- Flexo satinado.



GRIFOS TERMOSTÁTICOS EMPOTRADOS

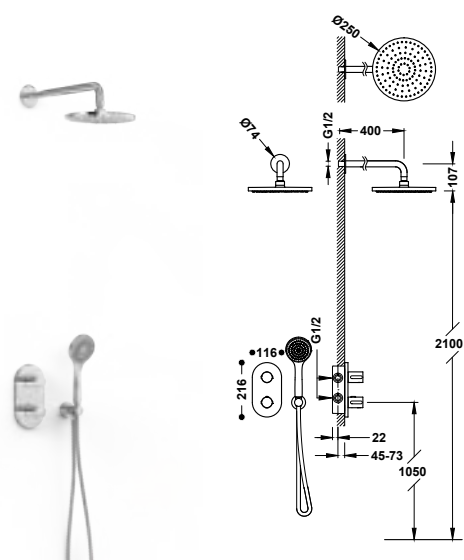

Kit de grifo termostático empotrado de 2 vías Therm-box para ducha

21525004

- Cuerpo empotrado incluido.
- Volante redondo de ABS con control de temperatura. Distribuidor cerámico de 2 vías.
- Brazo a pared con rociador de ducha orientable: Ø 250 mm.
- Soporte para ducha de mano con toma de agua a pared.
- Ducha de mano anticalcárea.
- Flexo metálico.



LLAVES DE PASO

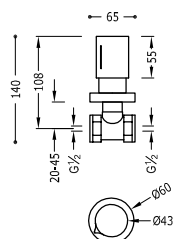

Llave de paso empotrada
Conexión a rosca hembra: 1/2".

06115501

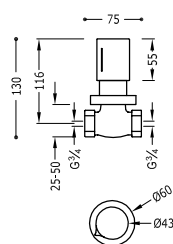

Llave de paso empotrada
Conexión a rosca hembra: 3/4".

06151101

CLASS

La serie Class nace con el claro objetivo de ofrecer todo el bienestar y confort posible en el cuarto de baño. Es una serie de líneas actuales que encaja a la perfección en todo tipo de espacios, tanto reducidos como amplios.

Acabados disponibles:



CR







GRIFOS PARA LAVABO

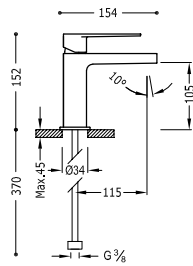

Grifo monomando para lavabo

Latiguillos de alimentación flexibles G3/8.

- 20510301
- 20510301D

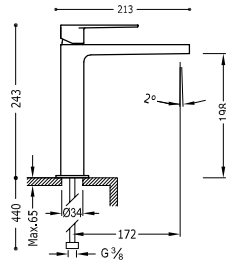

Grifo monomando alto para lavabo

Latiguillos de alimentación flexibles G3/8.

- 20510303

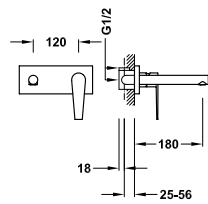

Grifo monomando empotrado para lavabo

Cuerpo empotrado indivisible con amortiguadores acústicos. Junta antihumedad. Caño de 180 mm.

- 20530011

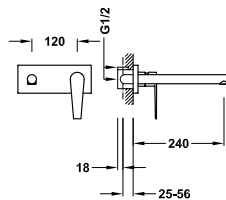

Grifo monomando empotrado para lavabo

Cuerpo empotrado indivisible con amortiguadores acústicos. Junta antihumedad. Caño de 240 mm.

- 20530012

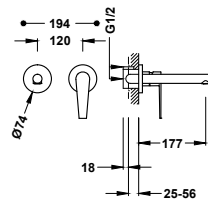

Grifo monomando empotrado para lavabo

Cuerpo empotrado indivisible con amortiguadores acústicos. Junta antihumedad. Caño de 177 mm.

- 20530001

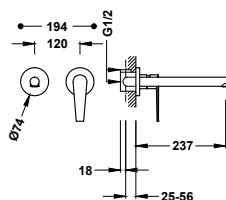

Grifo monomando empotrado para lavabo

Cuerpo empotrado indivisible con amortiguadores acústicos. Junta antihumedad. Caño de 237 mm.

- 20530002



GRIFOS PARA BIDÉ

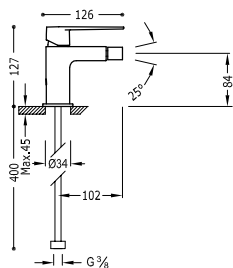

Grifo monomando para bidé
Rótula orientable. Latiguillos de alimentación flexibles G3/8.

20512001
20512001D



9130190

GRIFOS MURALES

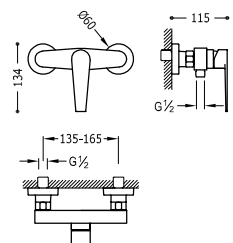

Grifo monomando mural para ducha
Ducha de mano anticalcárea. Soporte orientable para ducha de mano. Flexo satinado.

20516701



910719005

BELGAQUA

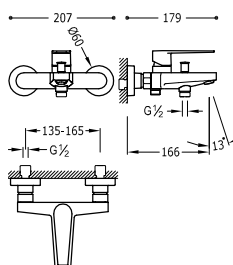

Grifo monomando mural para bañera y ducha
Ducha de mano anticalcárea. Soporte orientable para ducha de mano. Flexo satinado.

20517001



9130190

BELGAQUA

GRIFOS EMPOTRADOS RAPID-BOX

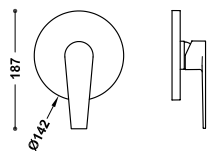

Pieza vista para caja empotrada de 1 vía Rapid-box
Sólo parte vista. Incluye placa embellecedora, mando, casquillo y tornillo de fijación oculto. Caja empotrada no incluida.

20527810



RAPID BOX



Caja empotrada de 1 vía Rapid-box con grifo monomando para ducha

20827810

N



Pieza vista para caja empotrada de 2 vías Rapid-box

20528110

Sólo parte vista. Incluye placa embellecedora, mando, volante distribuidor y tornillo de fijación oculto. Caja empotrada no incluida.

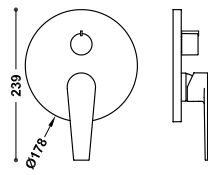

Caja empotrada de 2 vías Rapid-box con grifo monomando para ducha y bañera

20828110



Kit de grifo monomando empotrado de 2 vías Rapid-box para ducha

20528004

- Cuerpo empotrado incluido.
- Distribuidor cerámico de 2 vías.
- Brazo a pared con rociador de ducha orientable y de acero inoxidable: 300x300 mm.
- Soporte para ducha de mano con toma de agua a pared.
- Ducha de mano anticalcárea.
- Flexo satinado.

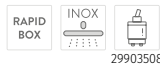
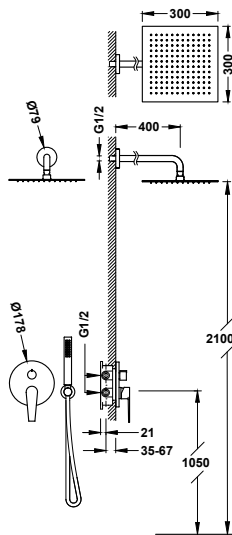

Kit de grifo monomando empotrado de 2 vías Rapid-box para ducha

20528003

- Cuerpo empotrado incluido.
- Distribuidor cerámico de 2 vías.
- Brazo a techo con rociador de ducha orientable y de acero inoxidable: 300x300 mm.
- Soporte para ducha de mano con toma de agua a pared.
- Ducha de mano anticalcárea.
- Flexo satinado.

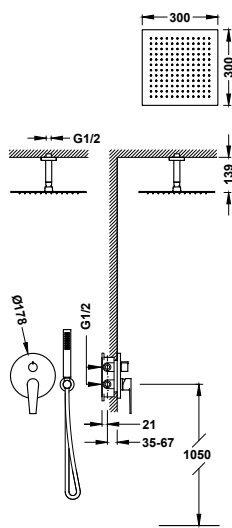

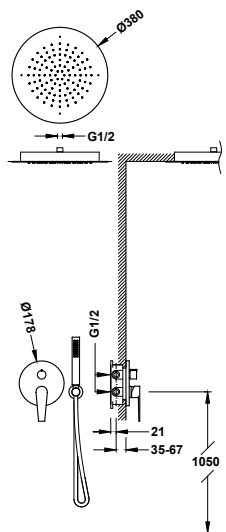

Kit de grifo monomando empotrado de 2 vías Rapid-box para ducha

20528005

- Cuerpo empotrado incluido.
- Distribuidor cerámico de 2 vías.
- Rociador de ducha empotrado a techo de acero inoxidable: Ø 380 mm.
- Soporte para ducha de mano con toma de agua a pared.
- Ducha de mano anticalcárea.
- Flexo satinado.



Kit de grifo monomando empotrado de 2 vías Rapid-box para bañera y ducha

20528006

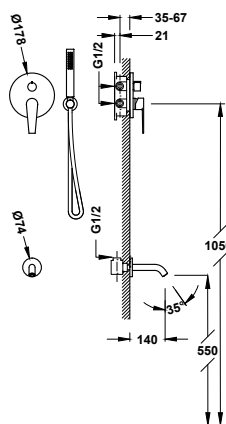

- Cuerpo empotrado incluido.
- Distribuidor cerámico de 2 vías.
- Caño fijo de bañera a pared.
- Soporte para ducha de mano con toma de agua a pared.
- Ducha de mano anticalcárea.
- Flexo satinado.



GRIFOS EMPOTRADOS

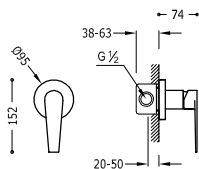

Grifo monomando empotrado de 1 vía para ducha

20517701

Cuerpo empotrado incluido.

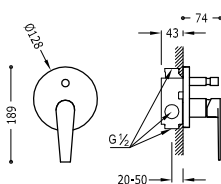

Grifo monomando empotrado de 2 vías para bañera y ducha

20518001

Cuerpo empotrado incluido. Inversor de 2 vías.



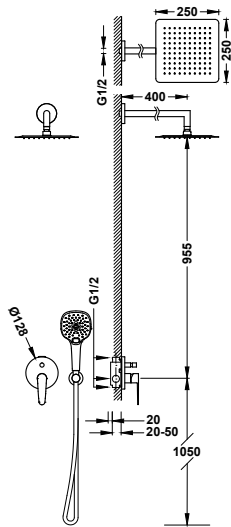

Kit de grifo monomando empotrado de 2 vías para ducha

20518006

- Cuerpo empotrado incluido.
- Inversor de 2 vías.
- Brazo a pared con rociador de ducha orientable y de acero inoxidable: 250x250 mm.
- Soporte para ducha de mano con toma de agua a pared.
- Ducha de mano anticalcárea: 120x120 mm. (3 tipos de chorro).
- Flexo satinado.

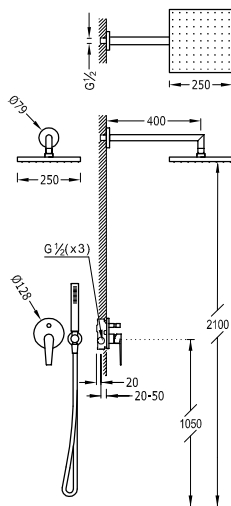

Kit de grifo monomando empotrado de 2 vías para ducha

20518002

- Cuerpo empotrado incluido.
- Inversor de 2 vías.
- Brazo a pared con rociador de ducha orientable y de acero inoxidable: 250x250 mm.
- Soporte para ducha de mano con toma de agua a pared.
- Ducha de mano anticalcárea.
- Flexo satinado.

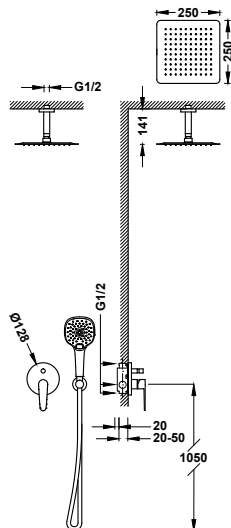

Kit de grifo monomando empotrado de 2 vías para ducha

20518007

- Cuerpo empotrado incluido.
- Inversor de 2 vías.
- Brazo a techo con rociador de ducha orientable y de acero inoxidable: 250x250 mm.
- Soporte para ducha de mano con toma de agua a pared.
- Ducha de mano anticalcárea: 120x120 mm. (3 tipos de chorro).
- Flexo satinado.



GRIFOS PARA BAÑERA

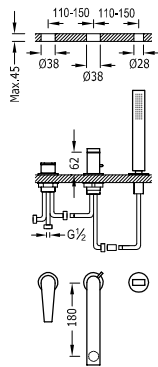

Grifo monomando para borde de bañera

20516103

- Inversor integrado en el caño de bañera.
- Ducha de mano anticalcárea.
- Caño de bañera de 180 mm. Caudal: 3 bar - 13 l/m.
- Kit depósito opcional no incluido ref.: 20024501.



Depósito para grifería de borde de bañera

20024501

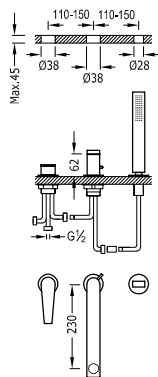

Grifo monomando para borde de bañera

20516101

- Inversor integrado en el caño de bañera.
- Ducha de mano anticalcárea.
- Caño de bañera de 230 mm. Caudal: 3 bar - 13 l/m.
- Kit depósito opcional no incluido ref.: 20024501.



Depósito para grifería de borde de bañera

20024501

GRIFOS TERMOSTÁTICOS MURALES

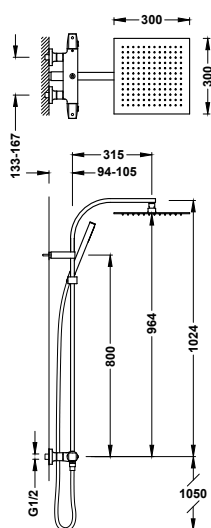

Conjunto de grifo termostático mural Over-wall de 2 vías para ducha

19039305

- Con inversor integrado en el regulador de caudal.
- Volante cuadrado-redondo.
- Rociador de ducha orientable de acero inoxidable: 300x300 mm.
- Soporte deslizante y orientable para ducha de mano.
- Ducha de mano anticalcárea de latón.
- Flexo satinado.



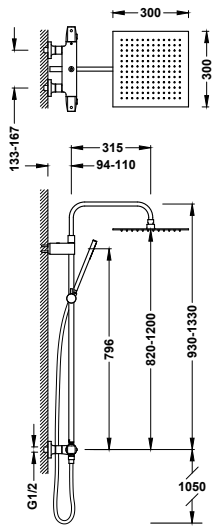

Conjunto de grifo termostático mural Over-wall de 2 vías para ducha

19039307

- Con inversor integrado en el regulador de caudal.
- Volante cuadrado-redondo.
- Barra de ducha telescópica.
- Rociador de ducha orientable de acero inoxidable: 300x300 mm.
- Soporte deslizante y orientable para ducha de mano.
- Ducha de mano anticalcárea de latón.
- Flexo satinado.



GRIFOS TERMOSTÁTICOS EMPOTRADOS

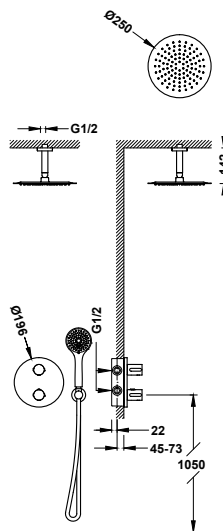

Kit de grifo termostático empotrado de 2 vías Therm-box para ducha

20425003

- Cuerpo empotrado incluido.
- Volante redondo de ABS con control de temperatura. Distribuidor cerámico de 2 vías.
- Brazo a techo con rociador de ducha orientable y de acero inoxidable: Ø 250 mm.
- Soporte para ducha de mano con toma de agua a pared.
- Ducha de mano anticalcárea: Ø 100 mm. (3 tipos de chorro).
- Flexo satinado.

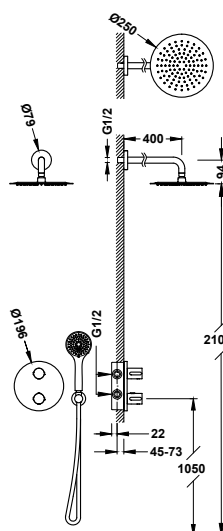

Kit de grifo termostático empotrado de 2 vías Therm-box para ducha

20425004

- Cuerpo empotrado incluido.
- Volante redondo de ABS con control de temperatura. Distribuidor cerámico de 2 vías.
- Brazo a pared con rociador de ducha orientable y de acero inoxidable: Ø 250 mm.
- Soporte para ducha de mano con toma de agua a pared.
- Ducha de mano anticalcárea: Ø 100 mm. (3 tipos de chorro).
- Flexo satinado.



FLAT

El punto fuerte de Flat reside en su sencillez. Esbelta, cómoda y funcional, esta serie da como resultado un baño asequible a la vez que especial. Flat es la sencillez que destaca.

Acabados disponibles:



CR





7

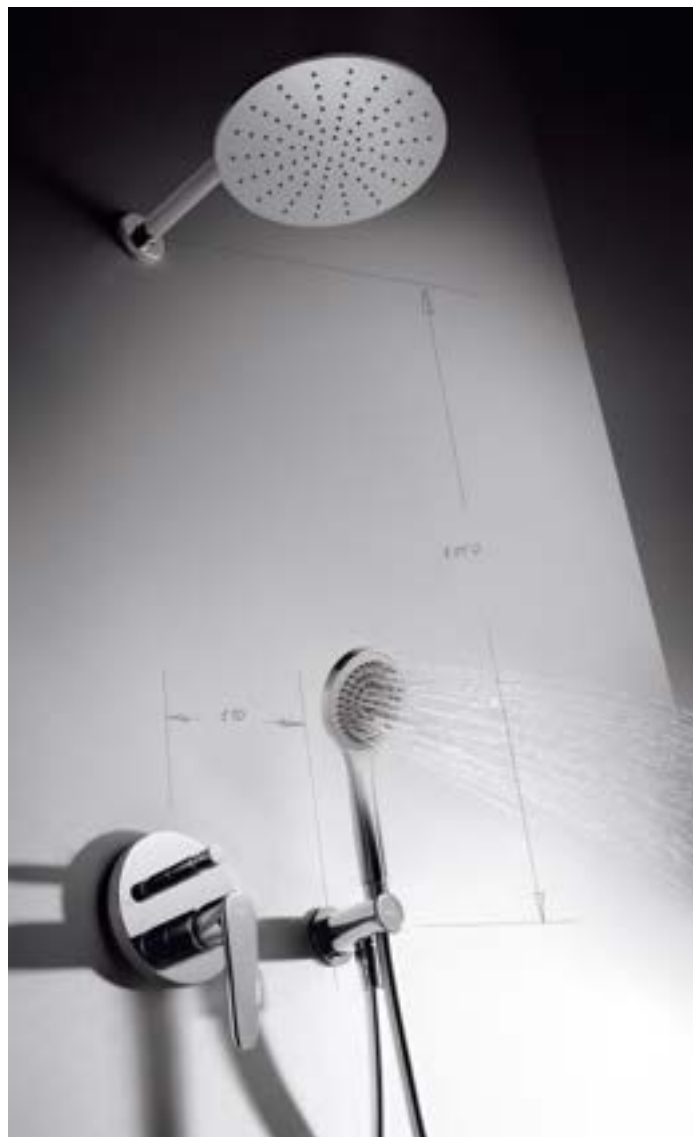

GRIFOS PARA LAVABO

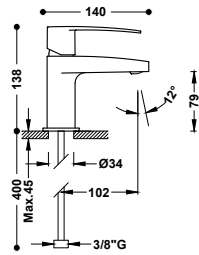

Grifo monomando para lavabo
Latiguillos de alimentación flexibles G3/8.

- 20410301
- 20410301D



9130190

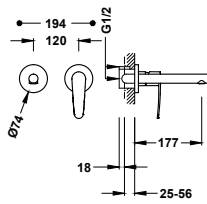

Grifo monomando empotrado para lavabo
Cuerpo empotrado indivisible con amortiguadores acústicos. Junta antihumedad. Caño de 177 mm.

- 20430001



29903507

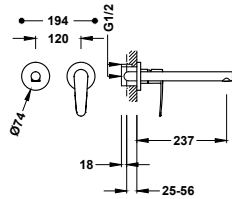

Grifo monomando empotrado para lavabo
Cuerpo empotrado indivisible con amortiguadores acústicos. Junta antihumedad. Caño de 237 mm.

- 20430002



29903507

GRIFOS PARA BIDÉ

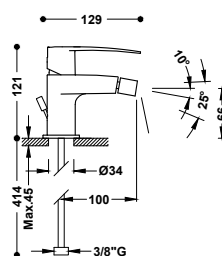

Grifo monomando para bidé
Latiguillos de alimentación flexibles G3/8.

- 20412001
- 20412001D



9130190

GRIFOS MURALES

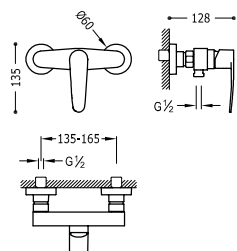

Grifo monomando mural para ducha

Ducha de mano anticalcárea. Soporte orientable para ducha de mano. Flexo satinado.

20416701

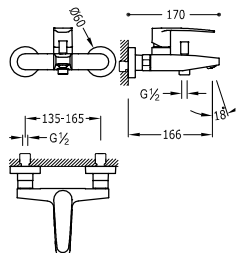

Grifo monomando mural para bañera y ducha

Ducha de mano anticalcárea. Soporte orientable para ducha de mano. Flexo satinado.

20417001



GRIFOS EMPOTRADOS RAPID-BOX

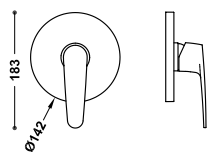

Pieza vista para caja empotrada de 1 vía Rapid-box

Sólo parte vista. Incluye placa embellecedora, mando, casquillo y tornillo de fijación oculto. **Caja empotrada no incluida.**

20427810



Caja empotrada de 1 vía Rapid-box con grifo monomando para ducha

20827810

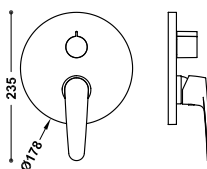

Pieza vista para caja empotrada de 2 vías Rapid-box

Sólo parte vista. Incluye placa embellecedora, mando, volante distribuidor y tornillo de fijación oculto. **Caja empotrada no incluida.**

20428110



Caja empotrada de 2 vías Rapid-box con grifo monomando para ducha y bañera

20828110



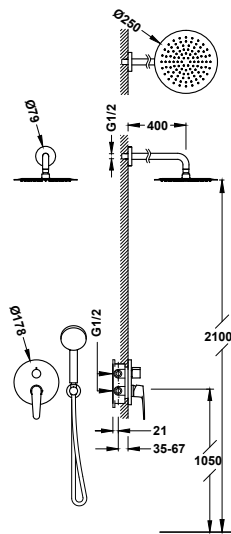

Kit de grifo monomando empotrado de 2 vías Rapid-box para ducha

20428004

- Cuerpo empotrado incluido.
- Distribuidor cerámico de 2 vías.
- Brazo a pared con rociador de ducha orientable y de acero inoxidable: Ø 250 mm.
- Soporte para ducha de mano con toma de agua a pared.
- Ducha de mano anticalcárea: Ø 110 mm.
- Flexo satinado.

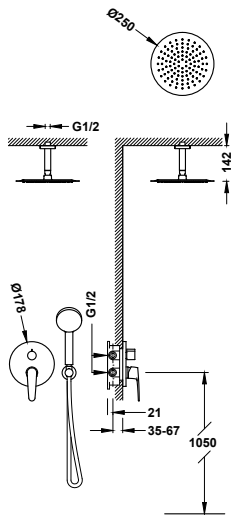

Kit de grifo monomando empotrado de 2 vías Rapid-box para ducha

20428003

- Cuerpo empotrado incluido.
- Distribuidor cerámico de 2 vías.
- Brazo a techo con rociador de ducha orientable y de acero inoxidable: Ø 250 mm.
- Soporte para ducha de mano con toma de agua a pared.
- Ducha de mano anticalcárea: Ø 110 mm.
- Flexo satinado.

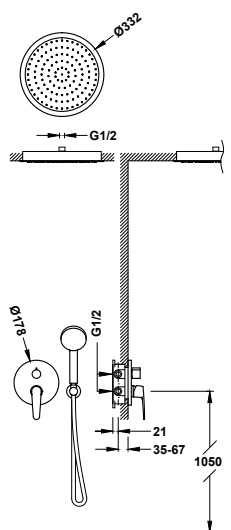

Kit de grifo monomando empotrado de 2 vías Rapid-box para ducha

20428005

- Cuerpo empotrado incluido.
- Distribuidor cerámico de 2 vías.
- Rociador empotrado a techo de latón: Ø 332 mm.
- Soporte para ducha de mano con toma de agua a pared.
- Ducha de mano anticalcárea: Ø 110 mm.
- Flexo satinado.



Kit de grifo monomando empotrado de 2 vías Rapid-box para bañera y ducha

20428006

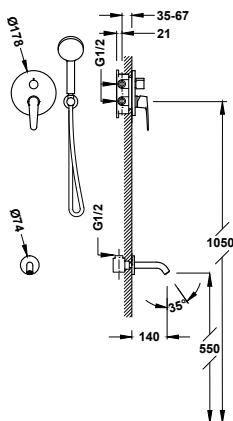

- Cuerpo empotrado incluido.
- Distribuidor cerámico de 2 vías.
- Caño fijo de bañera a pared.
- Soporte para ducha de mano con toma de agua a pared.
- Ducha de mano anticalcárea: Ø 110 mm.
- Flexo satinado.



GRIFOS EMPOTRADOS

Grifo monomando empotrado de 1 vía para ducha

20417701

Cuerpo empotrado incluido.

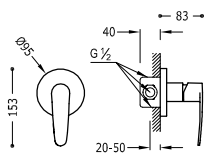

Grifo monomando empotrado de 2 vías para bañera y ducha

20418001

Cuerpo empotrado incluido. Inversor de 2 vías.

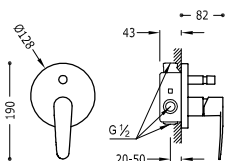

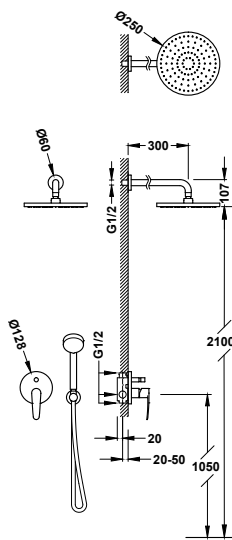

Kit de grifo monomando empotrado de 2 vías para ducha

20418002

- Cuerpo empotrado incluido.
- Inversor de 2 vías.
- Brazo a pared con rociador de ducha orientable y de acero inoxidable: Ø 250 mm.
- Soporte para ducha de mano con toma de agua a pared.
- Ducha de mano anticalcárea: Ø 100 mm.
- Flexo satinado.

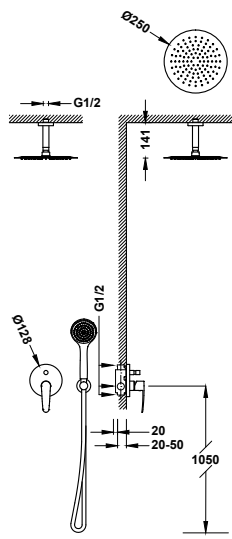

Kit de grifo monomando empotrado de 2 vías para ducha

20418005

- Cuerpo empotrado incluido.
- Inversor de 2 vías.
- Brazo a techo con rociador de ducha orientable y de acero inoxidable: Ø 250 mm.
- Soporte para ducha de mano con toma de agua a pared.
- Ducha de mano anticalcárea: Ø 100 mm.
- Flexo satinado.



GRIFOS TERMOSTÁTICOS MURALES

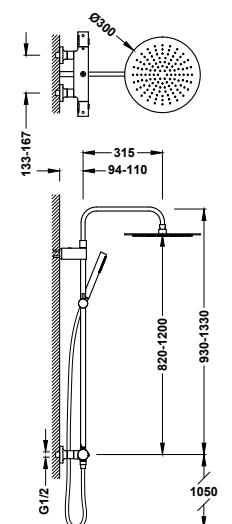

Conjunto de grifo termostático mural Over-wall de 2 vías para ducha

19039302

- Con inversor integrado en el regulador de caudal.
- Volante redondo.
- Barra de ducha telescópica.
- Rociador de ducha orientable de acero inoxidable: Ø 300 mm.
- Soporte deslizante y orientable para ducha de mano.
- Ducha de mano anticalcárea de latón.
- Flexo satinado.



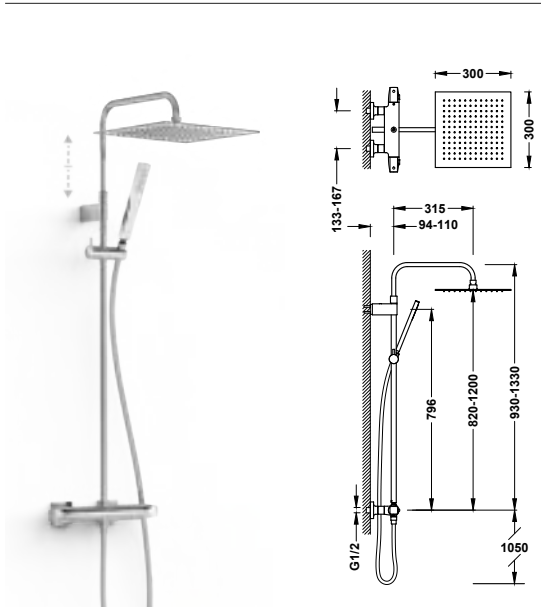

Conjunto de grifo termostático mural Over-wall de 2 vías para ducha

19039307

- Con inversor integrado en el regulador de caudal.
- Volante cuadrado-redondo.
- Barra de ducha telescópica.
- Rociador de ducha orientable de acero inoxidable: 300x300 mm.
- Soporte deslizante y orientable para ducha de mano.
- Ducha de mano anticalcárea de latón.
- Flexo satinado.



GRIFOS TERMOSTÁTICOS EMPOTRADOS

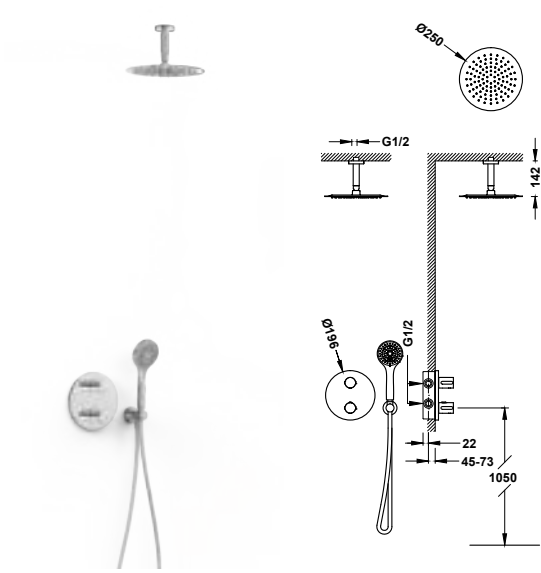

Kit de grifo termostático empotrado de 2 vías Therm-box para ducha

20425003

- Cuerpo empotrado incluido.
- Volante redondo de ABS con control de temperatura. Distribuidor cerámico de 2 vías.
- Brazo a techo con rociador de ducha orientable y de acero inoxidable: Ø 250 mm.
- Soporte para ducha de mano con toma de agua a pared.
- Ducha de mano anticalcárea: Ø 100 mm. (3 tipos de chorro).
- Flexo satinado.

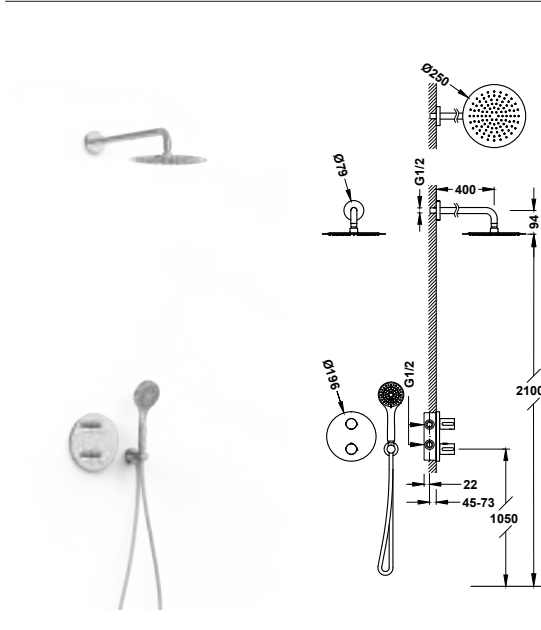

Kit de grifo termostático empotrado de 2 vías Therm-box para ducha

20425004

- Cuerpo empotrado incluido.
- Volante redondo de ABS con control de temperatura. Distribuidor cerámico de 2 vías.
- Brazo a pared con rociador de ducha orientable y de acero inoxidable: Ø 250 mm.
- Soporte para ducha de mano con toma de agua a pared.
- Ducha de mano anticalcárea: Ø 100 mm. (3 tipos de chorro).
- Flexo satinado.

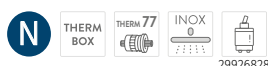

LLAVES DE PASO

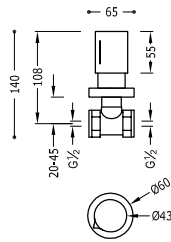

Llave de paso empotrada
Conexión a rosca hembra: 1/2".

06115501

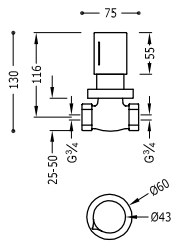

Llave de paso empotrada
Conexión a rosca hembra: 3/4".

06151101

CANIGÓ PLUS

El equilibrio entre el diseño y una buena experiencia en el baño no está reñido con la sostenibilidad. Canigó Plus incorpora en su grifería unas características que favorecen el ahorro de agua y energía ayudando a convertir cualquier baño en un espacio sostenible.

Acabados disponibles:



CR







GRIFOS PARA LAVABO

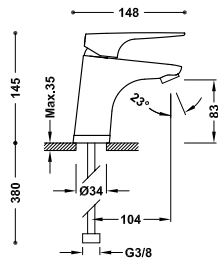

Grifo monomando para lavabo
Latiguillos de alimentación flexibles G3/8.

21810303

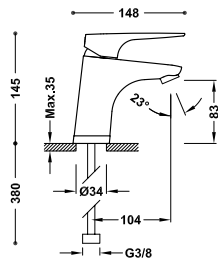

Grifo monomando para lavabo con Tres-Duo
Latiguillos de alimentación flexibles G3/8.

21810301

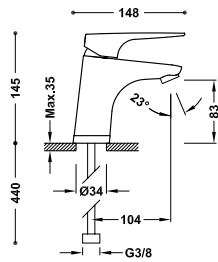

Grifo monomando ecoeficiente para lavabo
Latiguillos de alimentación flexibles G3/8.

21810401

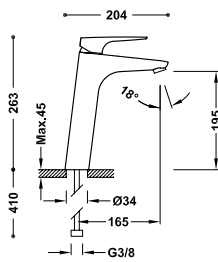

Grifo monomando alto para lavabo
Latiguillos de alimentación flexibles G3/8.

21820303

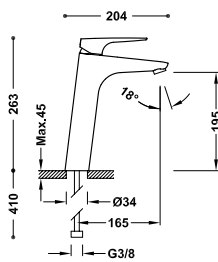

Grifo monomando alto para lavabo con Tres-Duo
Latiguillos de alimentación flexibles G3/8.

21820301



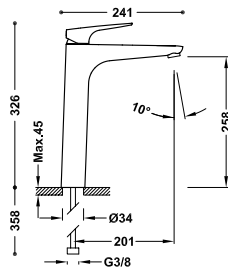

Grifo monomando XXL para lavabo
Latiguillos de alimentación flexibles G3/8.

21880301

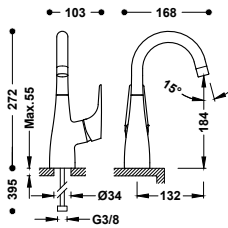

Grifo monomando con maneta lateral para lavabo
Latiguillos de alimentación flexibles G3/8.

21830802

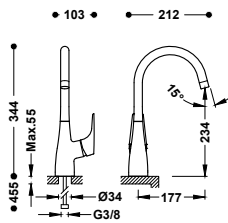

Grifo monomando alto con maneta lateral para lavabo
Latiguillos de alimentación flexibles G3/8.

21830801

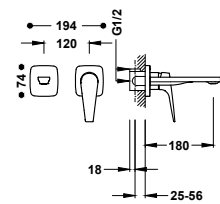

Grifo monomando empotrado para lavabo
Cuerpo empotrado indivisible con amortiguadores acústicos. Junta antihumedad. Caño de 180 mm.

21830003

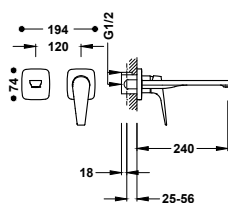

Grifo monomando empotrado para lavabo
Cuerpo empotrado indivisible con amortiguadores acústicos. Junta antihumedad. Caño de 240 mm.

21830004



GRIFOS PARA BIDÉ

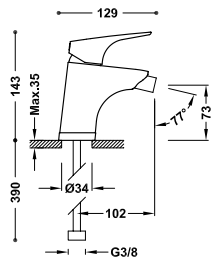

Grifo monomando para bidé
Latiguillos de alimentación flexibles G3/8.

21812001

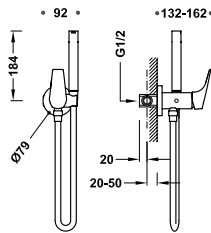

Grifo monomando empotrado con ducha para inodoro
Con agua fría o caliente. Ducha de mano con racor limitador a 5 l/min. y sistema antigoteo. Soporte fijo para la ducha de mano instalable a derecha o izquierda. Flexo satinado.

21712301



GRIFOS MURALES

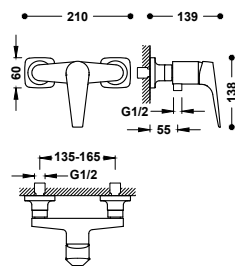

Grifo monomando mural para ducha
Sin complementos.

21826701

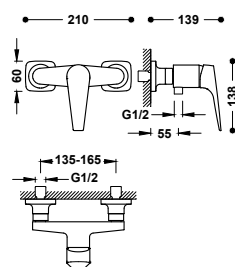

Grifo monomando mural para ducha
Ducha de mano anticalcárea 120x120 mm. (3 tipos de chorro). Soporte orientable para ducha de mano. Flexo metálico.

21816701



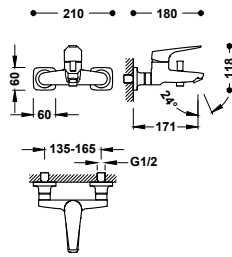

Grifo monomando mural para bañera y ducha
Sin complementos.

21827001

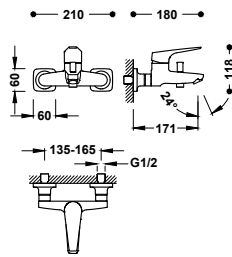

Grifo monomando mural para bañera y ducha
Ducha de mano anticalcárea 120x120 mm. (3 tipos de chorro). Soporte orientable para ducha de mano. Flexo metálico.

21817001

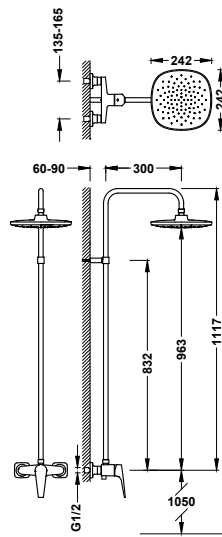

Conjunto de grifo monomando mural de 1 vía para ducha
· Rociador de ducha orientable: 242x242 mm.

21899501



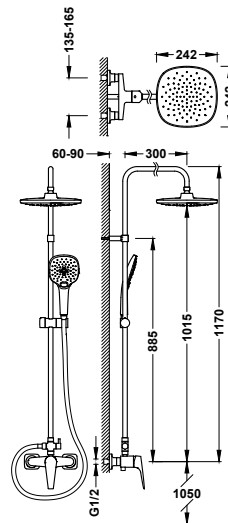

Conjunto de grifo monomando mural de 2 vías para ducha

21819101

- Con inversor integrado en la barra de ducha.
- Rociador de ducha orientable: 242x242 mm.
- Soporte deslizante y orientable para ducha de mano.
- Ducha de mano anticalcárea 120x120 mm. (3 tipos de chorro).
- Flexo metálico.



29903504

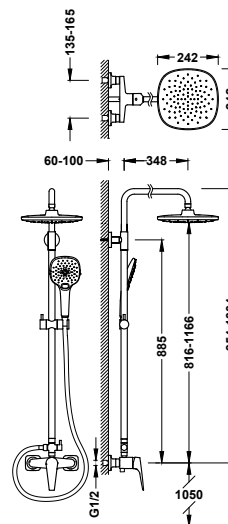

Conjunto de grifo monomando mural de 2 vías para ducha

21831221

- Con inversor integrado en la barra de ducha.
- Barra de ducha telescópica.
- Rociador de ducha orientable: 242x242 mm.
- Soporte deslizante y orientable para ducha de mano.
- Ducha de mano anticalcárea 120x120 mm. (3 tipos de chorro).
- Flexo metálico.



29903504



GRIFOS EMPOTRADOS RAPID-BOX

Pieza vista para caja empotrada de 1 vía Rapid-box

21827810

Sólo parte vista. Incluye placa embellecedora, mando, casquillo y tornillo de fijación oculto. **Caja empotrada no incluida.**

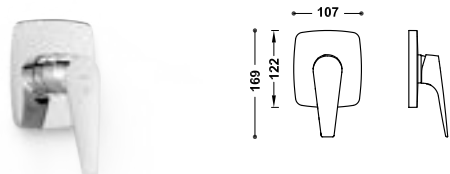

Caja empotrada de 1 vía Rapid-box con grifo monomando para ducha

20827810



Pieza vista para caja empotrada de 2 vías Rapid-box

21828110

Sólo parte vista. Incluye placa embellecedora, mando, volante distribuidor y tornillo de fijación oculto. **Caja empotrada no incluida.**

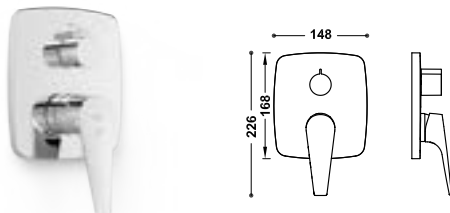

Caja empotrada de 2 vías Rapid-box con grifo monomando para ducha y bañera

20828110



Kit de grifo monomando empotrado de 2 vías Rapid-box para ducha

21828004

- Cuerpo empotrado incluido.
- Distribuidor cerámico de 2 vías.
- Brazo a pared con rociador de ducha orientable: 242x242 mm.
- Soporte para ducha de mano con toma de agua a pared.
- Ducha de mano anticalcárea 120x120 mm. (3 tipos de chorro).
- Flexo metálico.

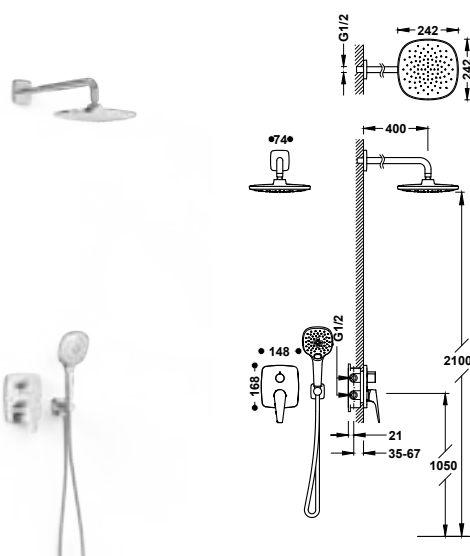

29903508

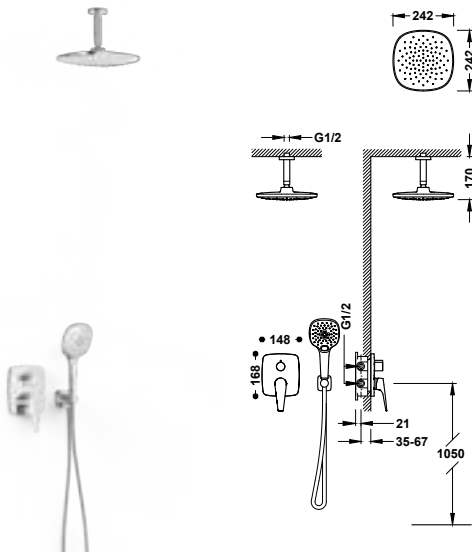

Kit de grifo monomando empotrado de 2 vías Rapid-box para ducha

21828003

- Cuerpo empotrado incluido.
- Distribuidor cerámico de 2 vías.
- Brazo a techo con rociador de ducha orientable: 242x242 mm.
- Soporte para ducha de mano con toma de agua a pared.
- Ducha de mano anticalcárea 120x120 mm. (3 tipos de chorro).
- Flexo metálico.



29903508

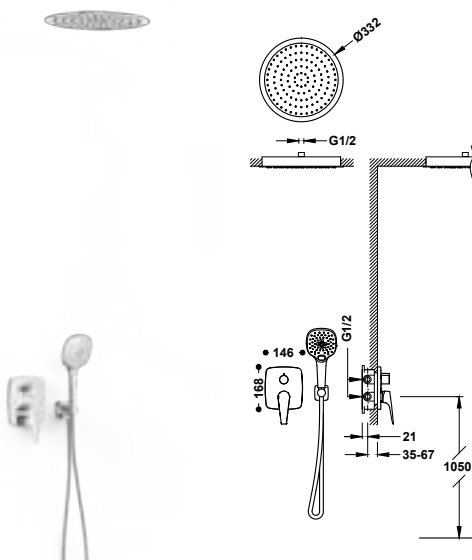

Kit de grifo monomando empotrado de 2 vías Rapid-box para ducha

21828005

- Cuerpo empotrado incluido.
- Distribuidor cerámico de 2 vías.
- Rociador empotrado a techo de latón: Ø 332 mm.
- Soporte para ducha de mano con toma de agua a pared.
- Ducha de mano anticalcárea 120x120 mm. (3 tipos de chorro).
- Flexo metálico.



29903508

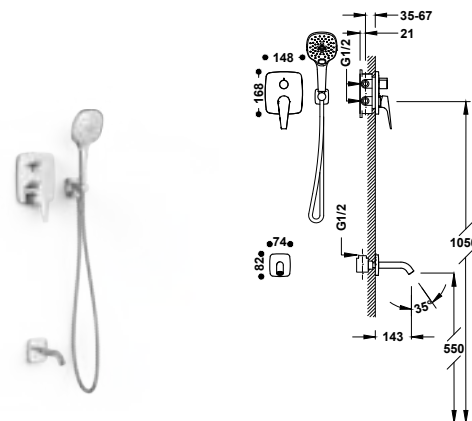

Kit de grifo monomando empotrado de 2 vías Rapid-box para bañera y ducha

21828006

- Cuerpo empotrado incluido.
- Distribuidor cerámico de 2 vías.
- Caño fijo de bañera a pared.
- Soporte para ducha de mano con toma de agua a pared.
- Ducha de mano anticalcárea 120x120 mm. (3 tipos de chorro).
- Flexo metálico.



29903508



GRIFOS TERMOSTÁTICOS MURALES

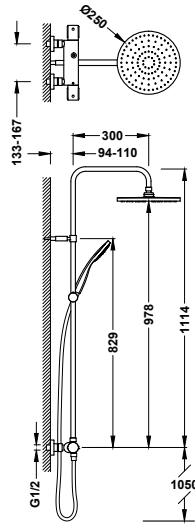

Conjunto de grifo termostático mural Over-wall de 2 vías para ducha

19039301

- Con inversor integrado en el regulador de caudal.
- Volante redondo de ABS.
- Rociador de ducha orientable: Ø 250 mm.
- Soporte deslizante y orientable para ducha de mano.
- Ducha de mano anticalcárea: Ø 100 mm.
- Flexo metálico.

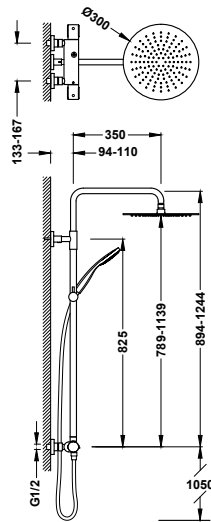

Conjunto de grifo termostático mural Over-wall de 2 vías para ducha

19038701

- Con inversor integrado en el regulador de caudal.
- Volante redondo de ABS.
- Barra de ducha telescópica.
- Rociador de ducha orientable de acero inoxidable: Ø 300 mm.
- Soporte deslizante y orientable para ducha de mano.
- Ducha de mano anticalcárea.
- Flexo metálico.



GRIFOS TERMOSTÁTICOS EMPOTRADOS

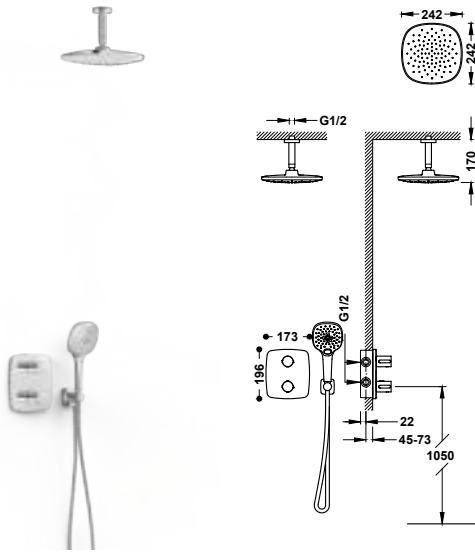

Kit de grifo termostático empotrado de 2 vías Therm-box para ducha

21725003

- Cuerpo empotrado incluido.
- Volante redondo de ABS con control de temperatura. Distribuidor cerámico de 2 vías.
- Brazo a techo con rociador de ducha orientable: 242x242 mm.
- Soporte para ducha de mano con toma de agua a pared.
- Ducha de mano anticalcárea 120x120 mm. (3 tipos de chorro).
- Flexo metálico.

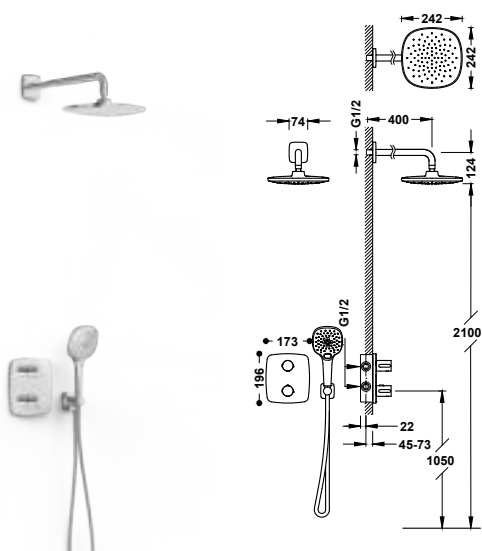

Kit de grifo termostático empotrado de 2 vías Therm-box para ducha

21725004

- Cuerpo empotrado incluido.
- Volante redondo de ABS con control de temperatura. Distribuidor cerámico de 2 vías.
- Brazo a pared con rociador de ducha orientable: 242x242 mm.
- Soporte para ducha de mano con toma de agua a pared.
- Ducha de mano anticalcárea 120x120 mm. (3 tipos de chorro).
- Flexo metálico.



CANIGÓ

Tres ha otorgado a la serie Canigó unas características que fomentan el ahorro de agua y de energía. La trayectoria inclinada de la maneta y la robustez de los cuerpos se integra con los ángulos redondeados de sus contornos, dotando de personalidad y diferenciación a toda la serie.

Acabados disponibles:



CR







GRIFOS PARA LAVABO

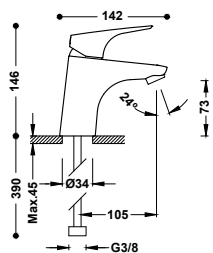

Grifo monomando para lavabo
Latiguillos de alimentación flexibles G3/8.

21710303

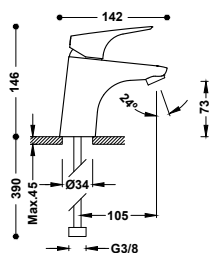

Grifo monomando para lavabo con Tres-Duo
Latiguillos de alimentación flexibles G3/8.

21710301

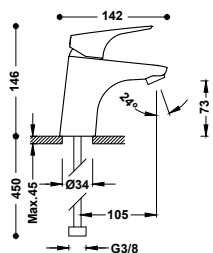

Grifo monomando ecoeficiente para lavabo
Latiguillos de alimentación flexibles G3/8.

21710401

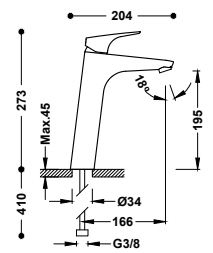

Grifo monomando alto para lavabo
Latiguillos de alimentación flexibles G3/8.

21720303

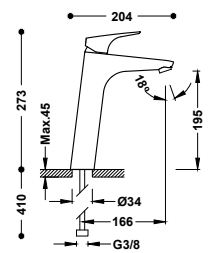

Grifo monomando alto para lavabo con Tres-Duo
Latiguillos de alimentación flexibles G3/8.

21720301





Grifo monomando empotrado para lavabo 21730001
 Cuerpo empotrado indivisible con amortiguadores acústicos. Junta antihumedad. Caño de 180 mm.

29902801

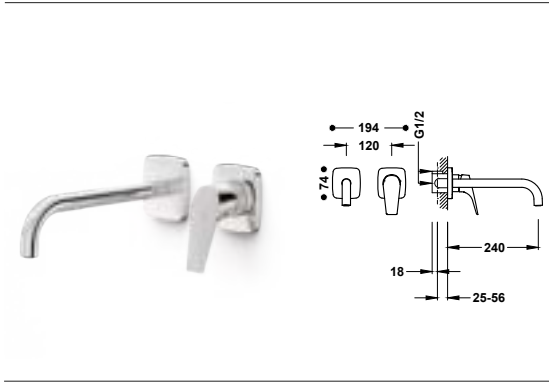

Grifo monomando empotrado para lavabo 21730002
 Cuerpo empotrado indivisible con amortiguadores acústicos. Junta antihumedad. Caño de 240 mm.

29902801

GRIFOS PARA BIDÉ

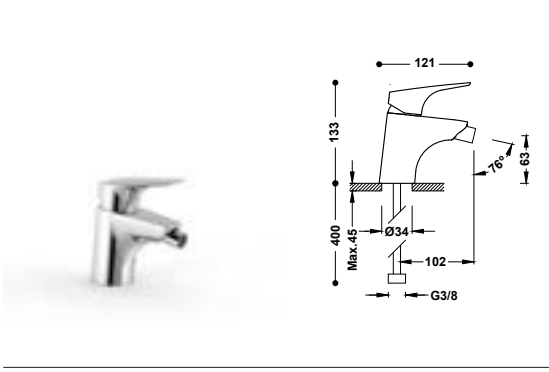

Grifo monomando para bidé 21712001
 Latiguillos de alimentación flexibles G3/8.

29903504

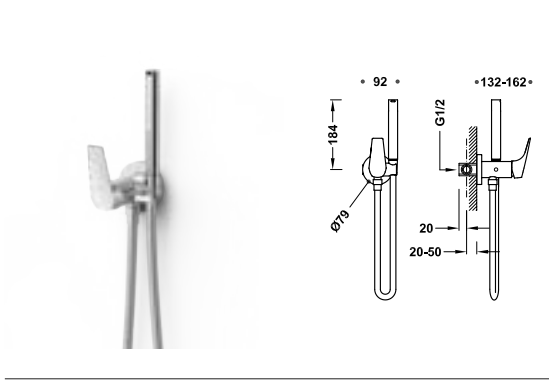

Grifo monomando empotrado con ducha para inodoro 21712301
 Con agua fría o caliente. Ducha de mano con racor limitador a 5 l/min. y sistema antigoteo. Soporte fijo para la ducha de mano instalable a derecha o izquierda. Flexo satinado.

9134591

GRIFOS MURALES

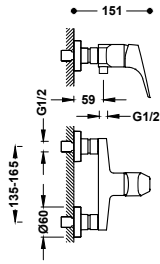

Grifo monomando mural para ducha
Sin complementos.

21726701

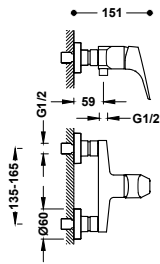

Grifo monomando mural para ducha
Ducha de mano anticalcárea 120x120 mm. (3 tipos de chorro). Soporte orientable para ducha de mano. Flexo metálico.

21716701

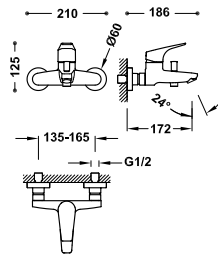

Grifo monomando mural para bañera y ducha
Sin complementos.

21727001

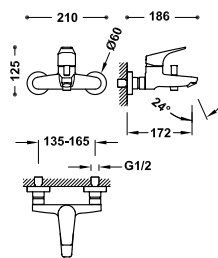

Grifo monomando mural para bañera y ducha
Ducha de mano anticalcárea 120x120 mm. (3 tipos de chorro). Soporte orientable para ducha de mano. Flexo metálico.

21717001



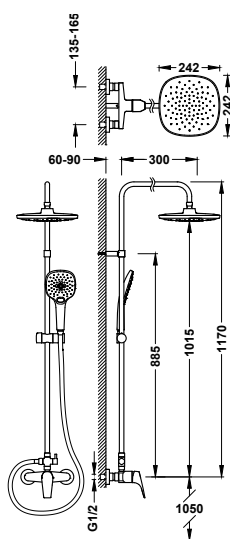

Conjunto de grifo monomando mural de 2 vías para ducha

21719101

- Con inversor integrado en la barra de ducha.
- Rociador de ducha orientable: 242x242 mm.
- Soporte deslizante y orientable para ducha de mano.
- Ducha de mano anticálcarea 120x120 mm. (3 tipos de chorro).
- Flexo metálico.

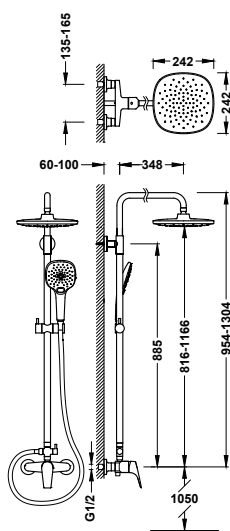

Conjunto de grifo monomando mural de 2 vías para ducha

21731221

- Con inversor integrado en la barra de ducha.
- Barra de ducha telescópica.
- Rociador de ducha orientable: 242x242 mm.
- Soporte deslizante y orientable para ducha de mano.
- Ducha de mano anticálcarea 120x120 mm. (3 tipos de chorro).
- Flexo metálico.



GRIFOS EMPOTRADOS RAPID-BOX

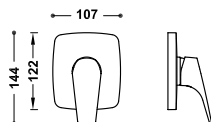

Pieza vista para caja empotrada de 1 vía Rapid-box

21727810

Sólo parte vista. Incluye placa embellecedora, mando, casquillo y tornillo de fijación oculto. **Caja empotrada no incluida.**



Caja empotrada de 1 vía Rapid-box con grifo monomando para ducha

20827810



Pieza vista para caja empotrada de 2 vías Rapid-box

21728110

Sólo parte vista. Incluye placa embellecedora, mando, volante distribuidor y tornillo de fijación oculto. Caja empotrada no incluida.

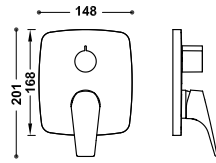

Caja empotrada de 2 vías Rapid-box con grifo monomando para ducha y bañera

20828110



Kit de grifo monomando empotrado de 2 vías Rapid-box para ducha

21728004

- Cuerpo empotrado incluido.
- Distribuidor cerámico de 2 vías.
- Brazo a pared con rociador de ducha orientable: 242x242 mm.
- Soporte para ducha de mano con toma de agua a pared.
- Ducha de mano anticalcárea 120x120 mm. (3 tipos de chorro).
- Flexo metálico.

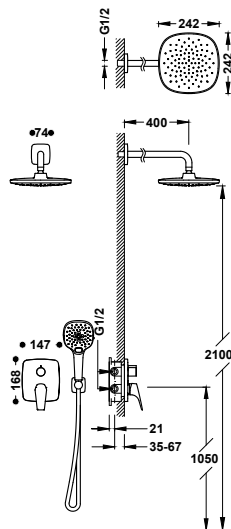

Kit de grifo monomando empotrado de 2 vías Rapid-box para ducha

21728003

- Cuerpo empotrado incluido.
- Distribuidor cerámico de 2 vías.
- Brazo a techo con rociador de ducha orientable: 242x242 mm.
- Soporte para ducha de mano con toma de agua a pared.
- Ducha de mano anticalcárea 120x120 mm. (3 tipos de chorro).
- Flexo metálico.

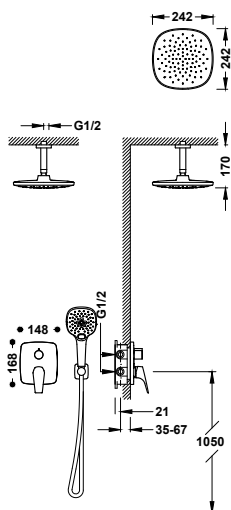

GRIFOS EMPOTRADOS

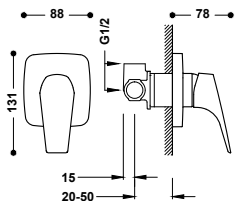

Grifo monomando empotrado de 1 vía para ducha
Cuerpo empotrado incluido.

21717701

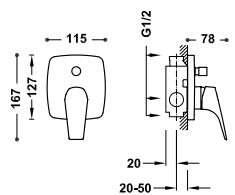

Grifo monomando empotrado de 2 vías para bañera y ducha
Cuerpo empotrado incluido. Inversor de 2 vías.

21718001



GRIFOS TERMOSTÁTICOS MURALES

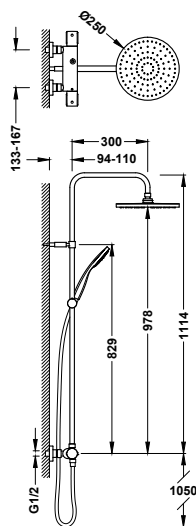

Conjunto de grifo termostático mural Over-wall de 2 vías para ducha

19039301

- Con inversor integrado en el regulador de caudal.
- Volante redondo de ABS.
- Rociador de ducha orientable: Ø 250 mm.
- Soporte deslizante y orientable para ducha de mano.
- Ducha de mano anticalcárea: Ø 100 mm.
- Flexo metálico.



OVER WALL



29916831XX

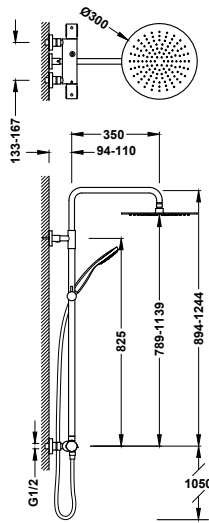

Conjunto de grifo termostático mural Over-wall de 2 vías para ducha

19038701

- Con inversor integrado en el regulador de caudal.
- Volante redondo de ABS.
- Barra de ducha telescópica.
- Rociador de ducha orientable de acero inoxidable: Ø 300 mm.
- Soporte deslizante y orientable para ducha de mano.
- Ducha de mano anticalcárea.
- Flexo metálico.



GRIFOS TERMOSTÁTICOS EMPOTRADOS

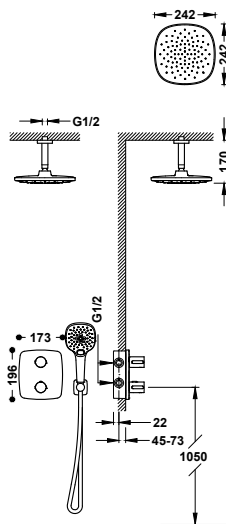

Kit de grifo termostático empotrado de 2 vías Therm-box para ducha

21725003

- Cuerpo empotrado incluido.
- Volante redondo de ABS con control de temperatura. Distribuidor cerámico de 2 vías.
- Brazo a techo con rociador de ducha orientable: 242x242 mm.
- Soporte para ducha de mano con toma de agua a pared.
- Ducha de mano anticalcárea 120x120 mm. (3 tipos de chorro).
- Flexo metálico.

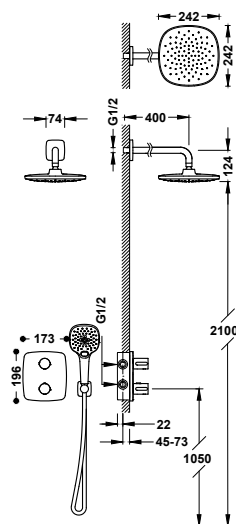

Kit de grifo termostático empotrado de 2 vías Therm-box para ducha

21725004

- Cuerpo empotrado incluido.
- Volante redondo de ABS con control de temperatura. Distribuidor cerámico de 2 vías.
- Brazo a pared con rociador de ducha orientable: 242x242 mm.
- Soporte para ducha de mano con toma de agua a pared.
- Ducha de mano anticalcárea 120x120 mm. (3 tipos de chorro).
- Flexo metálico.



BASE PLUS

La serie Base Plus se caracteriza por sus líneas simples y adaptables a cualquier ambiente. Su aspecto minimalista, así como un mando ergonómico y un cuerpo con líneas sinuosas, agradables y claras, permite equipar el baño con los elementos esenciales.

Acabados disponibles:



CR



NM







GRIFOS PARA LAVABO

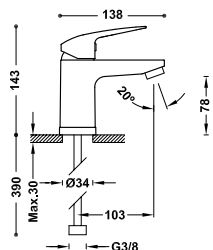

Grifo monomando para lavabo
Latiguillos de alimentación flexibles G3/8.

■ 21610303

■ 21610303NM

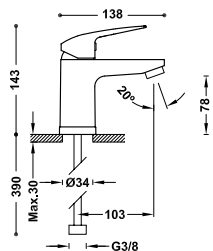

Grifo monomando para lavabo con Tres-Duo
Latiguillos de alimentación flexibles G3/8.

■ 21610310

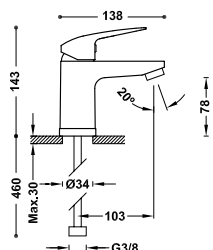

Grifo monomando ecoeficiente para lavabo
Latiguillos de alimentación flexibles G3/8.

■ 21610410

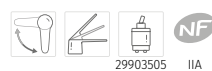

GRIFOS PARA BIDÉ

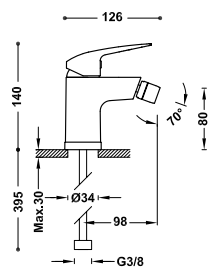

Grifo monomando para bidé
Latiguillos de alimentación flexibles G3/8.

■ 21612010

■ 21612010NM



GRIFOS MURALES

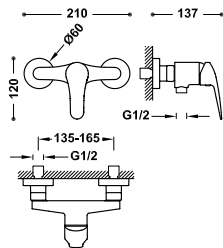

Grifo monomando mural para ducha
Sin complementos.

21626710

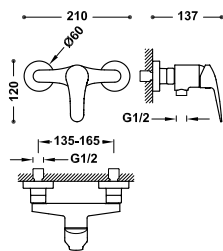

Grifo monomando mural para ducha
Ducha de mano anticalcárea. Soporte orientable para ducha de mano.
Flexo metálico.

21616710

21616710NM

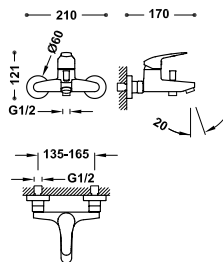

Grifo monomando mural para bañera y ducha
Sin complementos.

21627010

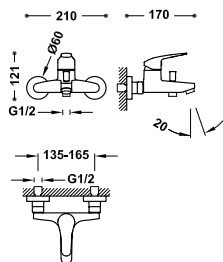

Grifo monomando mural para bañera y ducha
Ducha de mano anticalcárea. Soporte orientable para ducha de mano.
Flexo metálico.

21617010

21617010NM



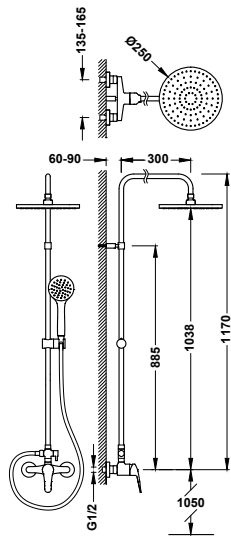

Conjunto de grifo monomando mural de 2 vías para ducha

■ 21619110

- Con inversor integrado en la barra de ducha.
- Rociador de ducha orientable: Ø 250 mm.
- Soporte deslizante y orientable para ducha de mano.
- Ducha de mano anticalcárea.
- Flexo metálico.



29903504

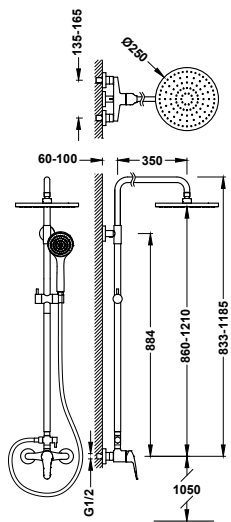

Conjunto de grifo monomando mural de 2 vías para ducha

■ 21631221

- Con inversor integrado en la barra de ducha.
- Rociador de ducha orientable: Ø 250 mm.
- Barra de ducha telescópica.
- Soporte deslizante y orientable para ducha de mano.
- Ducha de mano anticalcárea.
- Flexo metálico.



29903504



GRIFOS EMPOTRADOS RAPID-BOX

Pieza vista para caja empotrada de 1 vía Rapid-box

21627810

Sólo parte vista. Incluye placa embellecedora, mando, casquillo y tornillo de fijación oculto. Caja empotrada no incluida.

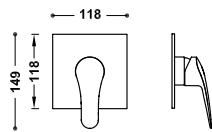

Caja empotrada de 1 vía Rapid-box con grifo monomando para ducha

20827810



Pieza vista para caja empotrada de 2 vías Rapid-box

21628110

Sólo parte vista. Incluye placa embellecedora, mando, volante distribuidor y tornillo de fijación oculto. Caja empotrada no incluida.

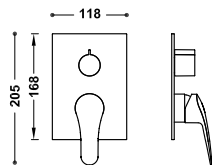

Caja empotrada de 2 vías Rapid-box con grifo monomando para ducha y bañera

20828110



Kit de grifo monomando empotrado de 2 vías Rapid-box para ducha

21628004

- Cuerpo empotrado incluido.
- Distribuidor cerámico de 2 vías.
- Brazo a pared con rociador de ducha orientable y de acero inoxidable: Ø 250 mm.
- Soporte para ducha de mano con toma de agua a pared.
- Ducha de mano anticalcárea: Ø 100 mm.
- Flexo metálico.

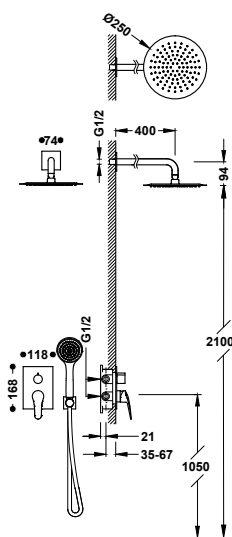

29903508

GRIFOS EMPOTRADOS

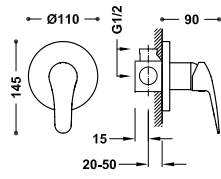

Grifo monomando empotrado de 1 vía para ducha
Cuerpo empotrado incluido.

21617701

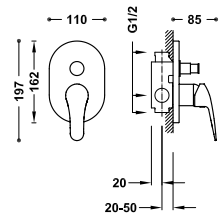

Grifo monomando empotrado de 2 vías para bañera y ducha
Cuerpo empotrado incluido. Inversor de 2 vías.

21618001



GRIFOS TERMOSTÁTICOS MURALES

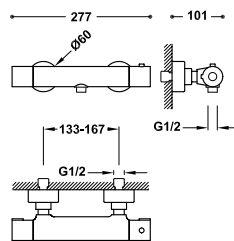

Grifo termostático mural para ducha
Sin complementos.

21616401

21616401NM

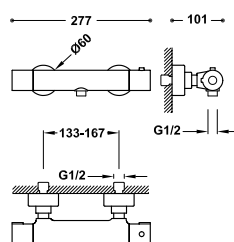

Grifo termostático mural para ducha
Ducha de mano anticalcárea: Ø 100 mm. Soporte orientable para ducha de mano. Flexo metálico.

21616409

21616409NM



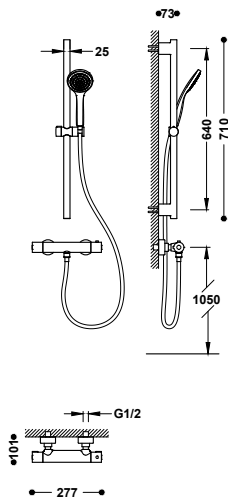

Kit de grifo termostático mural para ducha

- Barra de ducha: long. 640 mm.
- Soporte deslizante y orientable para ducha de mano.
- Ducha de mano anticalcárea: Ø 100 mm.
- Flexo metálico.

21619601

21619601NM

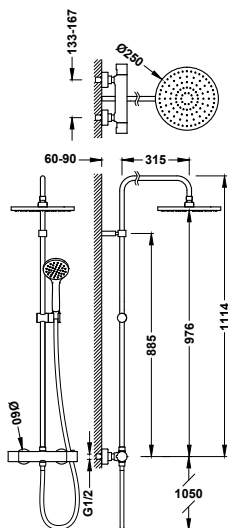

Conjunto de grifo termostático mural de 2 vías para ducha

- Con inversor integrado en el regulador de caudal.
- Rociador de ducha orientable: Ø 250 mm.
- Soporte deslizante y orientable para ducha de mano.
- Ducha de mano anticalcárea: Ø 100 mm.
- Flexo metálico.

21639301

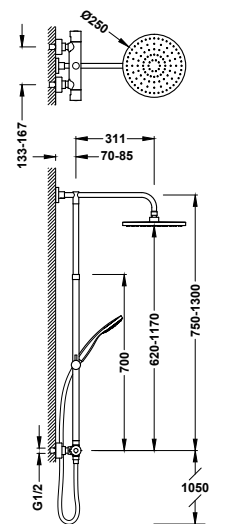

Conjunto de grifo termostático mural de 2 vías para ducha

- Con inversor integrado en el regulador de caudal.
- Barra de ducha de longitud variable hasta su fijación.
- Rociador de ducha orientable: Ø 250 mm.
- Soporte deslizante y orientable para ducha de mano.
- Ducha de mano anticalcárea: Ø 100 mm.
- Flexo satinado.

21639302NM



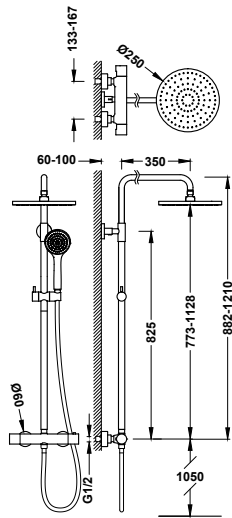

Conjunto de grifo termostático mural de 2 vías para ducha

21639521

- Con inversor integrado en el regulador de caudal.
- Barra de ducha telescópica.
- Rociador de ducha orientable: Ø 250 mm.
- Soporte deslizante y orientable para ducha de mano.
- Ducha de mano anticalcárea: Ø 100 mm.
- Flexo metálico.

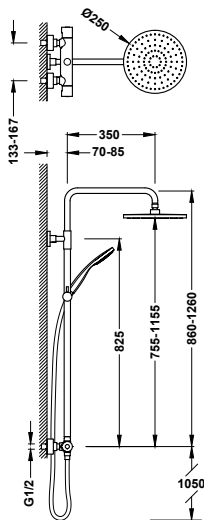

Conjunto de grifo termostático mural de 2 vías para ducha

21639502NM

- Con inversor integrado en el regulador de caudal.
- Barra de ducha telescópica.
- Rociador de ducha orientable: Ø 250 mm.
- Soporte deslizante y orientable para ducha de mano.
- Ducha de mano anticalcárea: Ø 100 mm.
- Flexo satinado.



GRIFOS TERMOSTÁTICOS EMPOTRADOS

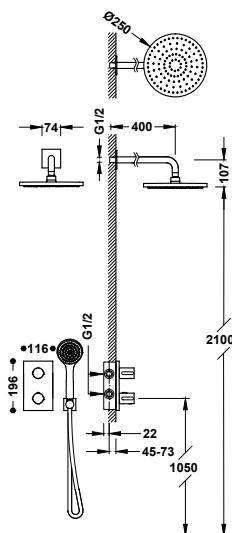

Kit de grifo termostático empotrado de 2 vías Therm-box para ducha

21625004

- Cuerpo empotrado incluido.
- Volante redondo de ABS con control de temperatura. Distribuidor cerámico de 2 vías.
- Brazo a pared con rociador de ducha orientable: Ø 250 mm.
- Soporte para ducha de mano con toma de agua a pared.
- Ducha de mano anticalcárea.
- Flexo metálico.



BASE

Con la serie Base se puede equipar el baño con lo esencial ya que cada grifo de esta serie cumple una función y ha sido diseñado para combinar la eficiencia y seguridad con la simpleza de su funcionalidad. Base es básicamente simple. Básicamente única.

Acabados disponibles:



CR







GRIFOS PARA LAVABO

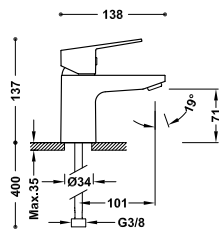

Grifo monomando para lavabo

Latiguillos de alimentación flexibles G3/8.

21510303

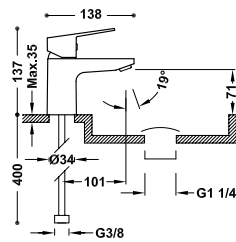

Grifo monomando para lavabo con válvula desagüe Click-Clack

Latiguillos de alimentación flexibles G3/8.

21510303D

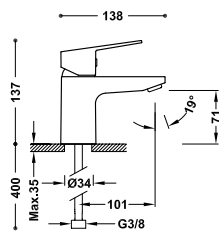
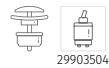

Grifo monomando para lavabo con Tres-Duo

Latiguillos de alimentación flexibles G3/8.

21510310

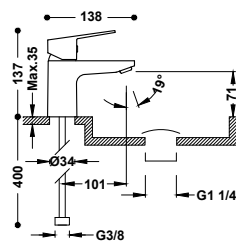

Grifo monomando para lavabo con Tres-Duo y válvula desagüe Click-Clack

Latiguillos de alimentación flexibles G3/8.

21510310D

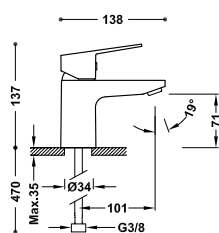

Grifo monomando ecoeficiente para lavabo

Latiguillos de alimentación flexibles G3/8.

21510410



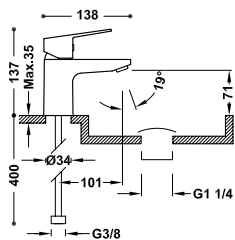

Grifo monomando ecoeficiente para lavabo con válvula desagüe Click-Clack

Latiguillos de alimentación flexibles G3/8.

21510410D



GRIFOS PARA BIDÉ

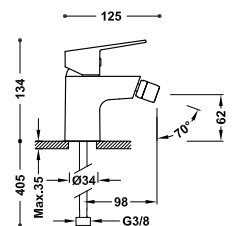

Grifo monomando para bidé

Latiguillos de alimentación flexibles G3/8.

21512010

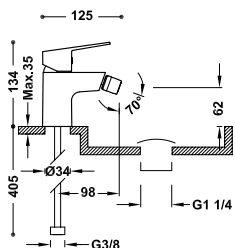

Grifo monomando para bidé con válvula desagüe Click-Clack

Latiguillos de alimentación flexibles G3/8.

21512010D



GRIFOS MURALES

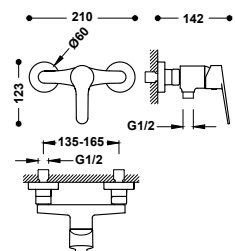

Grifo monomando mural para ducha

Sin complementos.

21526710

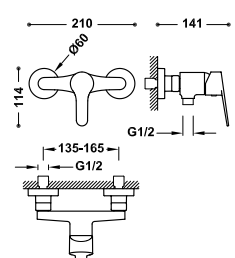

Grifo monomando mural para ducha

Ducha de mano anticálcarea. Soporte articulado para ducha de mano. Flexo metálico.

21516710



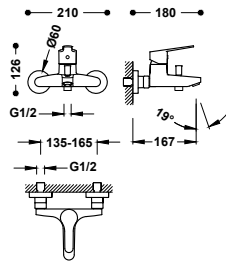

Grifo monomando mural para bañera y ducha
Sin complementos.

21527010

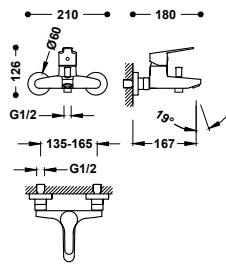

Grifo monomando mural para bañera y ducha
Ducha de mano anticalcárea. Soporte articulado para ducha de mano. Flexo metálico.

21517010



GRIFOS EMPOTRADOS RAPID-BOX

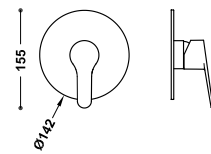

Pieza vista para caja empotrada de 1 vía Rapid-box

Sólo parte vista. Incluye placa embellecedora, mando, casquillo y tornillo de fijación oculto. Caja empotrada no incluida.

21527810



Caja empotrada de 1 vía Rapid-box con grifo monomando para ducha

20827810

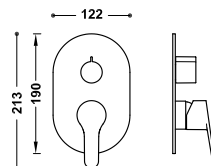

Pieza vista para caja empotrada de 2 vías Rapid-box

Sólo parte vista. Incluye placa embellecedora, mando, volante distribuidor y tornillo de fijación oculto. Caja empotrada no incluida.

21528110



Caja empotrada de 2 vías Rapid-box con grifo monomando para ducha y bañera

20828110



GRIFOS EMPOTRADOS

Grifo monomando empotrado de 1 vía para ducha
Cuerpo empotrado incluido.

21517701

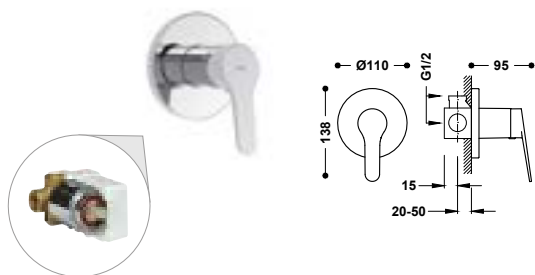

Grifo monomando empotrado de 2 vías para bañera y ducha
Cuerpo empotrado incluido. Inversor de 2 vías.

21518001

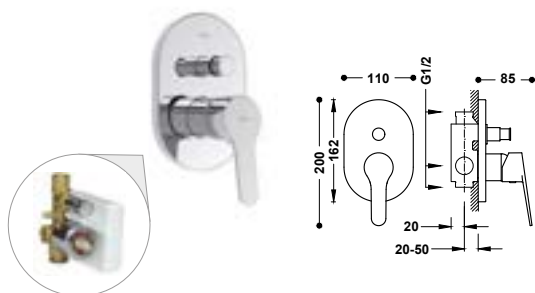

Kit de grifo monomando empotrado de 2 vías para ducha

21599002

- Cuerpo empotrado incluido.
- Inversor de 2 vías.
- Brazo a pared con rociador de ducha orientable: Ø 250 mm.
- Soporte para ducha de mano con toma de agua a pared.
- Ducha de mano anticalcárea.
- Flexo metálico.

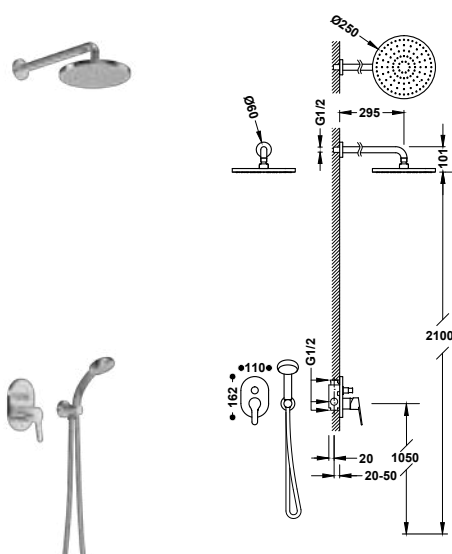

GRIFOS PARA VARIOS USOS

Grifo de 1 agua para lavabo
Con latiguillo de alimentación flexible G3/8.

06250301

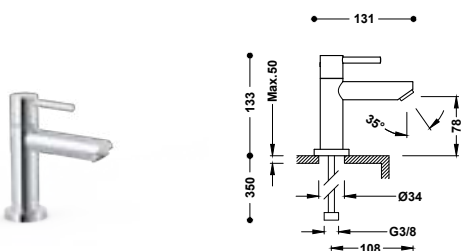

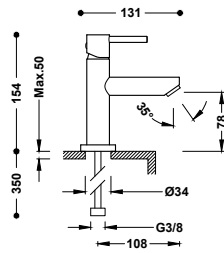

Grifo monomando para lavabo
Latiguillos de alimentación flexibles G3/8.

06260301

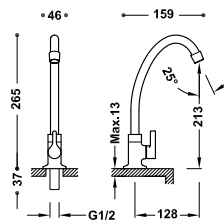

Grifo de 1 agua con maneta lateral para office o lavadero
Con conexión roscada macho de G1/2.

21530601

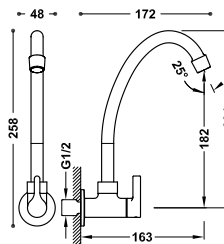

Grifo mural de 1 agua para office o lavadero
Con conexión roscada macho de G1/2.

21550601

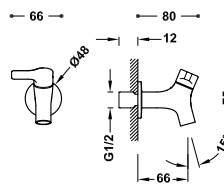

Grifo mural de 1 agua para office o lavadero
Con conexión roscada macho de G1/2. Caño de 66 mm.

21552001

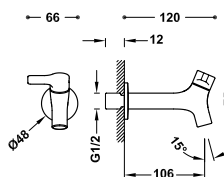

Grifo mural de 1 agua para office o lavadero
Con conexión roscada macho de G1/2. Caño de 106 mm.

21552002

ESE-23

La serie bimando Ese-23 es la alternativa asequible para la grifería básica. Los volantes retro con indicadores de agua caliente o fría y sus cuerpos condensados caracterizan una serie con las piezas principales para una vivienda.

Acabados disponibles:



CR





GRIFOS PARA LAVABO

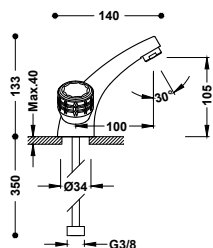

Grifo bimando para lavabo
Latiguillos de alimentación flexibles G3/8.

■ 123103



9134284

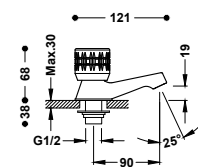

Grifo de 1 agua para lavabo
Conexión roscada macho de G1/2. Con índice azul.

❄️ ■ 123100F
☀️ ■ 123100C



9134284

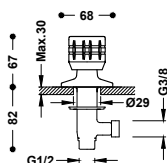

Grifo lateral sin caño para lavabo

❄️ ■ 123510F
☀️ ■ 123510C



9134285

GRIFOS PARA BIDÉ

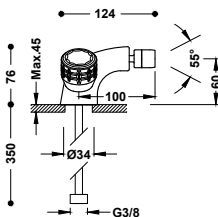

Grifo bimando para bidé
Latiguillos de alimentación flexibles G3/8.

■ 123120



9134284

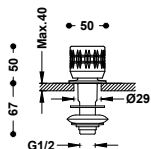

Grifo lateral sin caño para bidé
Conexión roscada macho de G1/2.

❄️ ■ 123125F
☀️ ■ 123125C



9134284

GRIFOS MURALES

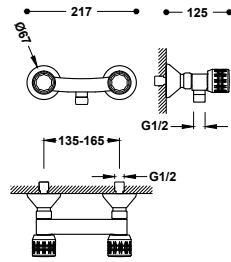

Grifo bimando mural para ducha

■ 123167

Ducha de mano anticalcárea. Soporte orientable para ducha de mano. Flexo metálico reforzado.

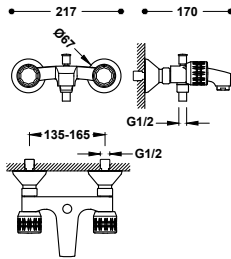

Grifo bimando mural para bañera y ducha

■ 123170

Ducha de mano anticalcárea. Soporte orientable para ducha de mano. Flexo metálico reforzado.



GRIFOS PARA VARIOS USOS

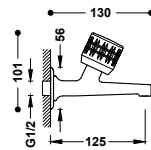

Grifo mural de 1 agua para office o lavadero

❄ ■ 123520F
☀ ■ 123520C

Conexión roscada macho de G1/2.

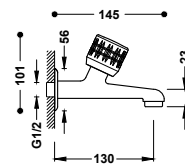

Grifo mural de 1 agua para office o lavadero

❄ ■ 02352001F
☀ ■ 02352001C

Conexión roscada macho de G1/2.

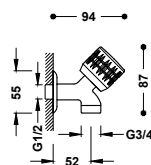

Grifo mural de 1 agua para lavadora

❄ ■ 123500F
☀ ■ 123500C

Conexión roscada macho de G1/2.



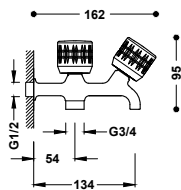

Grifo mural doble de 1 agua para lavadora

Salida 1: Conexión roscada macho: 3/4". Salida 2: a lavadero.

123515

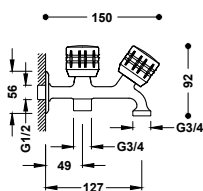

Grifo mural doble de 1 agua para lavadora

Salida 1 y 2: Conexión roscada macho: 3/4".

02351501



LLAVES DE PASO

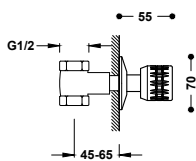

Llave de paso empotrada 1/2"

Conexión roscada hembra: 1/2".

123155F
123155C

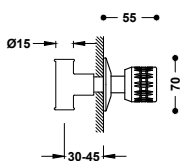

Llave de paso empotrada Ø 15 mm

Conexión soldada hembra: Ø 15 mm.

123511F
123511C

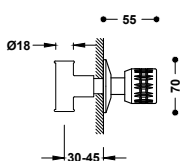

Llave de paso empotrada Ø 18 mm

Conexión soldada hembra: Ø 18 mm.

123512F
123512C



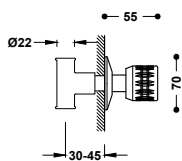

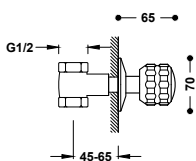

Llave de paso empotrada Ø 22 mm
Conexión soldada hembra: Ø 22 mm.

-   123513F
-   123513C





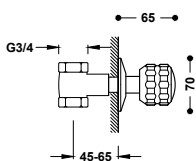

Llave de paso empotrada 1/2"
Conexión roscada hembra: 1/2".

-   13315510F
-   13315510C



Llave de paso empotrada 3/4"
Conexión roscada hembra: 3/4".

-   13315710F
-   13315710C

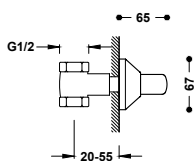

Llave de paso empotrada con regulación oculta 1/2"
Conexión roscada hembra: 1/2".

-  133516

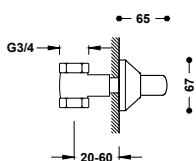

Llave de paso empotrada con regulación oculta 3/4"
Conexión roscada hembra: 3/4".

-  133517



ESPACIO DE DUCHA





ELECTRÓNICOS

Shower Technology 228

TERMOSTÁTICOS

Empotrados B-system 242

Empotrados Therm-box 252

Murales Over-wall 272

MONOMANDOS

Empotrados 3V 290

Empotrados Rapid-box 298

Empotrados 322

Murales 336

Borde de bañera 346

SHOWER TECHNOLOGY

Equipar la ducha o bañera con Shower technology da mucha más satisfacción. Tres ha mejorado su innovación electrónica para tener un control absoluto de la ducha. La ducha está al servicio del usuario ya que integra nuevas capacidades para aumentar su seguridad, el ahorro de agua y la comodidad para ducharse cuando todo esté listo.

Acabados disponibles:



CR



NM



OM



OPM





Shower technology

La ducha electrónica al siguiente nivel



- Ⓐ Pantalla de información
- Ⓑ Selector de temperatura
- Ⓒ Control de caudal
- Ⓓ Encendido, apagado y pausa
- Ⓔ Control de salida del agua

De 2 a 4 salidas de agua distintas

El control digital está adaptado para cada conjunto de ducha, según la cantidad de vías de salida de agua que se deseen. De esa forma, con solo tocar la pantalla, se activa la salida deseada, sea el rociador, la ducha, los jets o la cascada. Las versiones de 3 y 4 salidas permiten utilizar dos salidas de agua a la vez en un único uso.



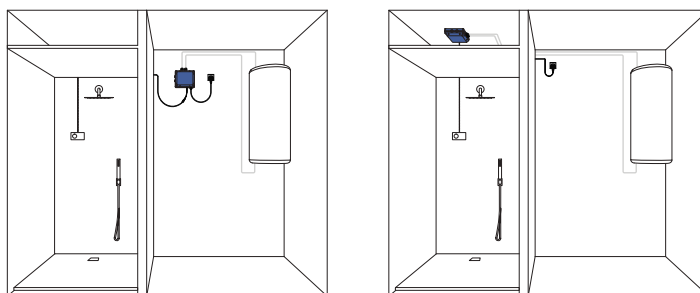
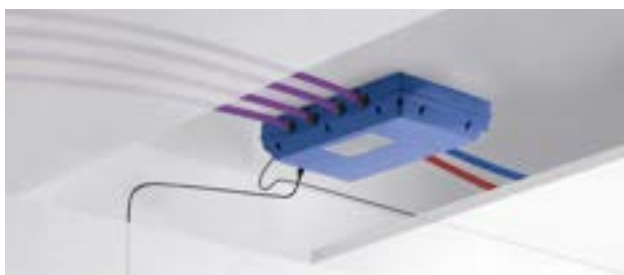

Instalación en el mínimo espacio

La centralita termostática electrónica se puede instalar hasta un máximo de 10 metros de distancia de la pantalla de control.

Tiene las mejores juntas antihumedad

Sistema empotrado totalmente estanco y antihumedades con juntas Schlüter.

Pantalla hermética

La pantalla de control es totalmente hermética, con iluminación en los botones en funcionamiento y con acabado en blanco o en negro.

Temperatura precisa

La temperatura se encuentra en 38°C cuando se abre inicialmente. Su límite es 46°C como máximo. El nivel de temperatura seleccionada se indica numéricamente y en escala de colores.

Prepara tu ducha para que esté perfecta cuando entres

El grifo se parará cuando llegue a la temperatura programada y la ducha estará preparada para que entres cuando quieras.

Permite la desinfección de la legionela

Incluye un programa para prevenir la legionela (5 minutos a 60°C) o directamente para desinfectar (10 minutos a 60°C).



COMPLETA TU DUCHA ELECTRÓNICA



+

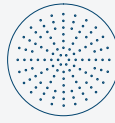

2 vías (492 862 99 - 492 882 99)

3 vías (492 863 98 - 492 883 98)

3 vías (492 863 99 - 492 883 99)

4 vías (492 864 99 - 492 884 99)

Se recomienda la instalación de complementos de ducha de Tres para garantizar su buen funcionamiento.

PANTALLA DE CONTROL

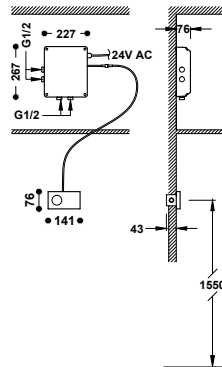

Control termostático electrónico empotrado de 2 vías Shower Technology Blue Edition

49286299

49288299

- Control electrónico incluido con juntas antihumedad Schlüter.
- Centralita termostática electrónica incluida (2 vías).
- Temperatura mínima disponible inferior a los 25°C.
- Sistema puesta a punto: Preparación de la temperatura deseada.
- Con programas antilegionela.

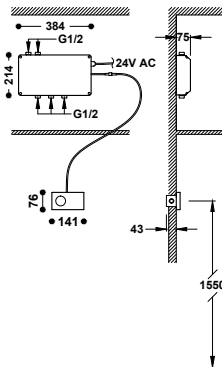

Control termostático electrónico empotrado de 3 vías Shower Technology Blue Edition

49286398

49288398

- Control electrónico incluido con juntas antihumedad Schlüter.
- Centralita termostática electrónica incluida (3 vías).
- Temperatura mínima disponible inferior a los 25°C.
- Sistema puesta a punto: Preparación de la temperatura deseada.
- Con programas antilegionela.



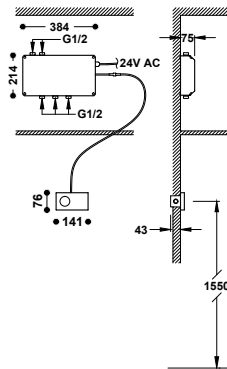

**Control termostático electrónico empotrado de 3 vías
Shower Technology Blue Edition**

- Control electrónico incluido con juntas antihumedad Schlüter.
- Centralita termostática electrónica incluida (3 vías).
- Temperatura mínima disponible inferior a los 25°C.
- Sistema puesta a punto: Preparación de la temperatura deseada.
- Con programas antilegionela.

- 49286399
- 49288399

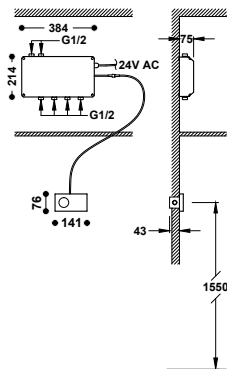

**Control termostático electrónico empotrado de 4 vías
Shower Technology Blue Edition**

- Control electrónico incluido con juntas antihumedad Schlüter.
- Centralita termostática electrónica incluida (4 vías).
- Temperatura mínima disponible inferior a los 25°C.
- Sistema puesta a punto: Preparación de la temperatura deseada.
- Con programas antilegionela.

- 49286499
- 49288499

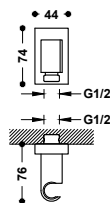

Soporte fijo con toma de agua para ducha de mano y flexo
Con toma de agua a pared. Válvula antirretorno. Material: Latón.

- 20718201
- 20718201NM
- 20718201BM
- 20718201AC
- 20718201OR
- 20718201OM
- 20718201OPM



KITS DE 2 VÍAS

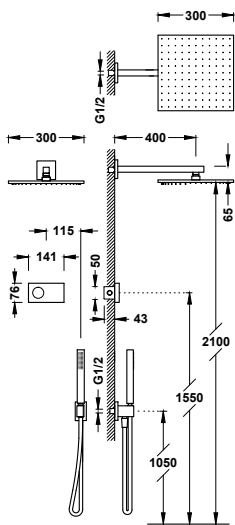

**Kit de grifo termostático electrónico empotrado de 2 vías
Shower Technology Blue Edition para ducha**

- Control electrónico incluido con juntas antihumedad Schlüter.
- Centralita termostática electrónica incluida (2 vías).
- Brazo a pared con rociador de ducha orientable y de acero inoxidable: 300x300 mm.
- Soporte para ducha de mano con toma de agua a pared.
- Ducha de mano anticalcárea de latón.
- Flexo satinado.

- 09286563
- 09286563OM
- 09286563OPM



- 09288563NM

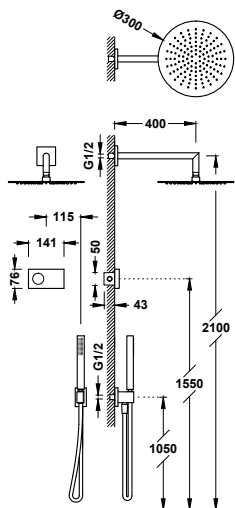

**Kit de grifo termostático electrónico empotrado de 2 vías
Shower Technology Blue Edition para ducha**

- Control electrónico incluido con juntas antihumedad Schlüter.
- Centralita termostática electrónica incluida (2 vías).
- Brazo a pared con rociador de ducha orientable y de acero inoxidable: Ø 300 mm.
- Soporte para ducha de mano con toma de agua a pared.
- Ducha de mano anticalcárea de latón.
- Flexo satinado.

- 09286558
- 09286558OM
- 09286558OPM



- 09288558NM

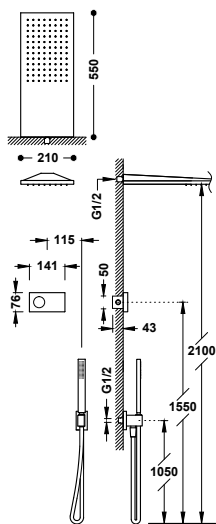
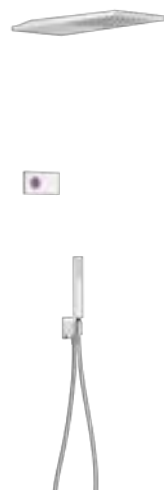

**Kit de grifo termostático electrónico empotrado de 2 vías
Shower Technology Blue Edition para ducha**

- Control electrónico incluido con juntas antihumedad Schlüter.
- Centralita termostática electrónica incluida de 2 vías.
- Rociador de ducha a pared de acero inoxidable: 210x550 mm.
- Soporte para ducha de mano con toma de agua a pared.
- Ducha de mano anticalcárea de latón.
- Flexo satinado.

- 09286551
- 09286551OM
- 09286551OPM



- 09288551NM



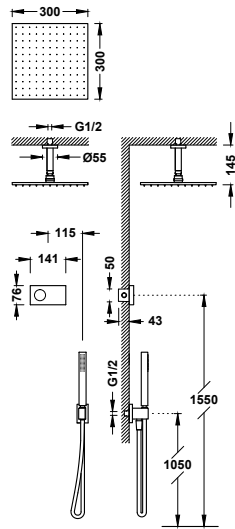

**Kit de grifo termostático electrónico empotrado de 2 vías
Shower Technology Blue Edition para ducha**

- Control electrónico incluido con juntas antihumedad Schlüter.
- Centralita termostática electrónica incluida (2 vías).
- Brazo a techo con rociador de ducha orientable y de acero inoxidable: 300x300 mm.
- Soporte para ducha de mano con toma de agua a pared.
- Ducha de mano anticalcárea de latón.
- Flexo satinado.

- 09286564
- 09286564OM
- 09286564OPM

N
N



- 09288564NM

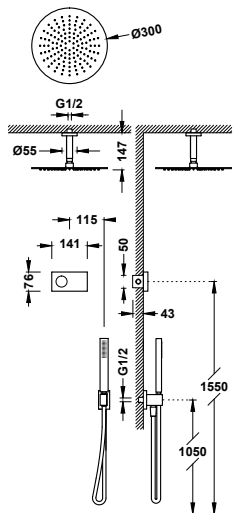

**Kit de grifo termostático electrónico empotrado de 2 vías
Shower Technology Blue Edition para ducha**

- Control electrónico incluido con juntas antihumedad Schlüter.
- Centralita termostática electrónica incluida (2 vías).
- Brazo a techo con rociador de ducha orientable y de acero inoxidable: Ø 300 mm.
- Soporte para ducha de mano con toma de agua a pared.
- Ducha de mano anticalcárea de latón.
- Flexo satinado.

- 09286567
- 09286567OM
- 09286567OPM

N
N



- 09288567NM

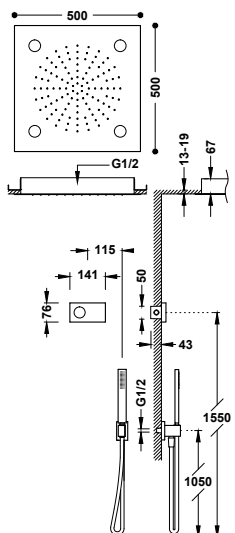

Kit de grifo termostático electrónico empotrado de 2 vías Shower Technology Blue Edition con Cromoterapia para ducha

- Control electrónico incluido con juntas antihumedad Schlüter.
- Centralita termostática electrónica incluida (2 vías).
- Rociador de ducha empotrado a techo con Cromoterapia de acero inoxidable: 500x500 mm
- Soporte para ducha de mano con toma de agua a pared.
- Ducha de mano anticalcárea de latón.
- Flexo satinado.

- 09286562



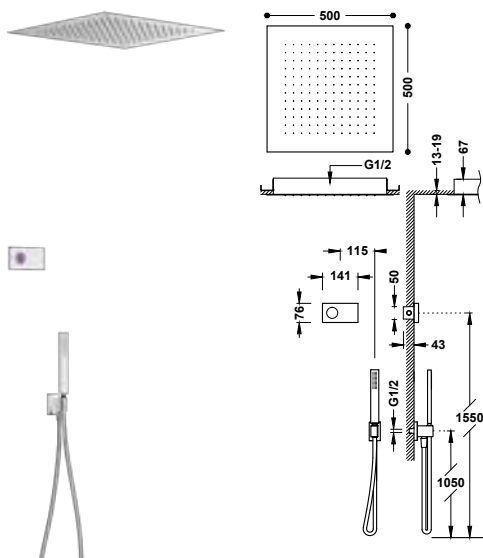

**Kit de grifo termostático electrónico empotrado de 2 vías
Shower Technology Blue Edition para ducha**

- Control electrónico incluido con juntas antihumedad Schlüter.
- Centralita termostática electrónica incluida (2 vías).
- Rociador de ducha empotrado a techo de acero inoxidable: 500x500 mm.
- Soporte para ducha de mano con toma de agua a pared.
- Ducha de mano anticalcárea de latón.
- Flexo satinado.

09286561



09288561NM

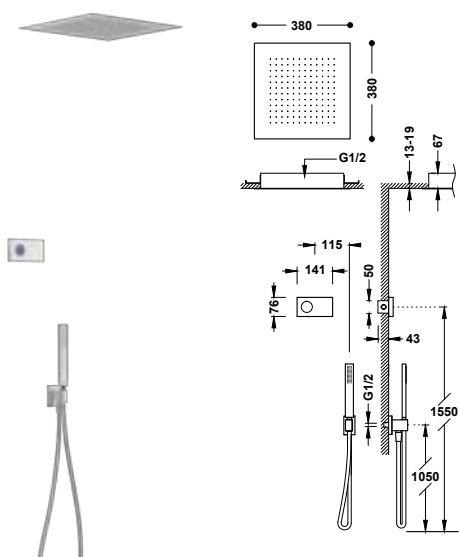

**Kit de grifo termostático electrónico empotrado de 2 vías
Shower Technology Blue Edition para ducha**

- Control electrónico incluido con juntas antihumedad Schlüter.
- Centralita termostática electrónica incluida (2 vías).
- Rociador de ducha empotrado a techo de acero inoxidable: 380x380 mm.
- Soporte para ducha de mano con toma de agua a pared.
- Ducha de mano anticalcárea de latón.
- Flexo satinado.

09286552



09288552NM

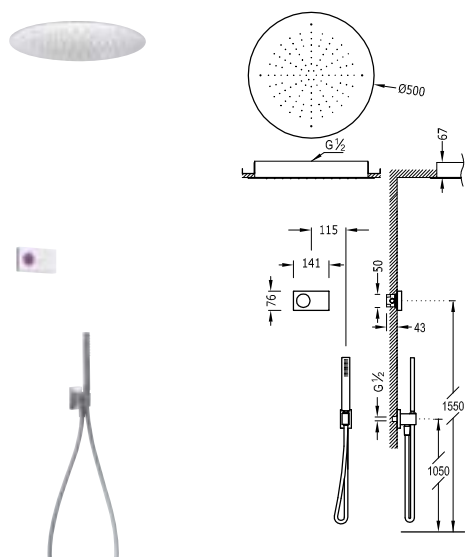

**Kit de grifo termostático electrónico empotrado de 2 vías
Shower Technology Blue Edition para ducha**

- Control electrónico incluido con juntas antihumedad Schlüter.
- Centralita termostática electrónica incluida (2 vías).
- Rociador de ducha empotrado a techo de acero inoxidable: Ø 500 mm.
- Soporte para ducha de mano con toma de agua a pared.
- Ducha de mano anticalcárea de latón.
- Flexo satinado.

09286557



09288557NM



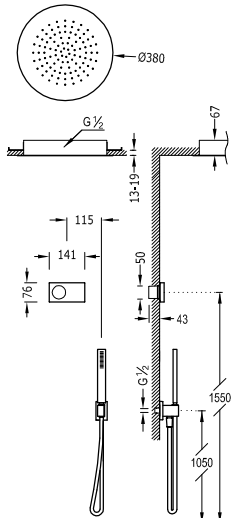

**Kit de grifo termostático electrónico empotrado de 2 vías
Shower Technology Blue Edition para ducha**

- Control electrónico incluido con juntas antihumedad Schlüter.
- Centralita termostática electrónica incluida (2 vías).
- Rociador de ducha empotrado a techo de acero inoxidable: Ø 380 mm.
- Soporte para ducha de mano con toma de agua a pared.
- Ducha de mano anticalcárea de latón.
- Flexo satinado.

09286555



09288555NM

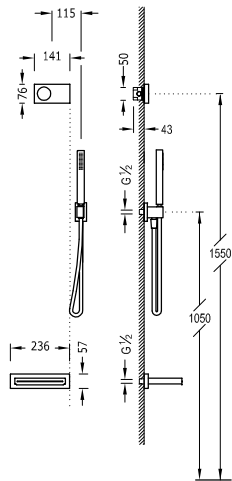

**Kit de grifo termostático electrónico empotrado de 2 vías
Shower Technology Blue Edition para bañera y ducha**

- Control electrónico incluido con juntas antihumedad Schlüter.
- Centralita termostática electrónica incluida (2 vías).
- Caño fijo de pared con salida en cascada.
- Soporte para ducha de mano con toma de agua a pared.
- Ducha de mano anticalcárea de latón.
- Flexo satinado.

09286556



09288556NM



KITS DE 3 VÍAS

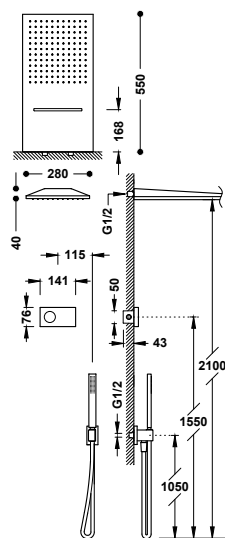

Kit de grifo termostático electrónico empotrado de 3 vías Shower Technology Blue Edition para ducha

- Control electrónico incluido con juntas antihumedad Schlüter.
- Centralita termostática electrónica incluida (3 vías).
- Rociador de ducha a pared de acero inoxidable con 2 tipos de chorro (lluvia/cascada). 280x550 mm. **IMPORTANTE:** Montar un desagüe de >50 l/min.
- Soporte para ducha de mano con toma de agua a pared.
- Ducha de mano anticalcárea de latón.
- Flexo satinado.

- 09286308
- 09286308OM
- 09286308OPM
- 09288308NM

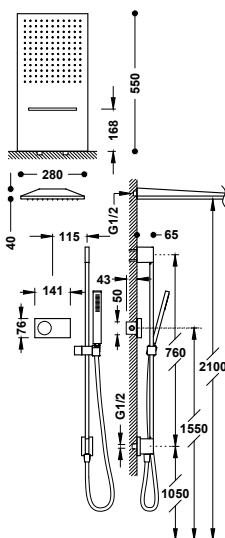

Kit de grifo termostático electrónico empotrado de 3 vías Shower Technology Blue Edition para ducha

- Control electrónico incluido con juntas antihumedad Schlüter.
- Centralita termostática electrónica incluida (3 vías).
- Rociador de ducha a pared de acero inoxidable con 2 tipos de chorro (lluvia/cascada). 280x550 mm. **IMPORTANTE:** Montar un desagüe de >50 l/min.
- Barra deslizante para ducha con toma de agua a pared.
- Ducha de mano anticalcárea de latón.
- Flexo satinado.

- 09286307

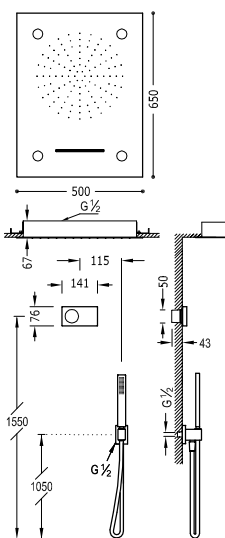

Kit de grifo termostático electrónico empotrado de 3 vías Shower Technology Blue Edition con Cromoterapia para ducha

- Control electrónico incluido con juntas antihumedad Schlüter.
- Centralita termostática electrónica incluida (3 vías).
- Rociador de ducha empotrado a techo con Cromoterapia de acero inoxidable con 2 tipos de chorro (lluvia/cascada). 500x650 mm. **IMPORTANTE:** Montar un desagüe de >50 l/min.
- Soporte para ducha de mano con toma de agua a pared.
- Ducha de mano anticalcárea de latón.
- Flexo satinado.

- 09286302



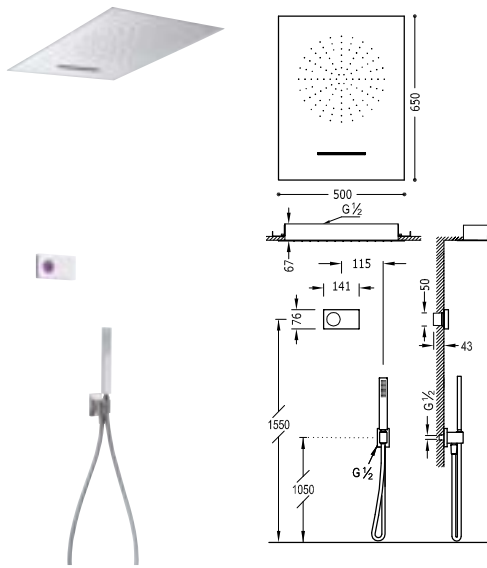

**Kit de grifo termostático electrónico empotrado de 3 vías
Shower Technology Blue Edition para ducha**

09286304



- Control electrónico incluido con juntas antihumedad Schlüter.
- Centralita termostática electrónica incluida (3 vías).
- Rociador de ducha empotrado a techo de acero inoxidable con 2 tipos de chorro (lluvia/cascada). 500x650 mm. IMPORTANTE: Montar un desagüe de >50 l/min.
- Soporte para ducha de mano con toma de agua a pared.
- Ducha de mano anticalcárea de latón.
- Flexo satinado.

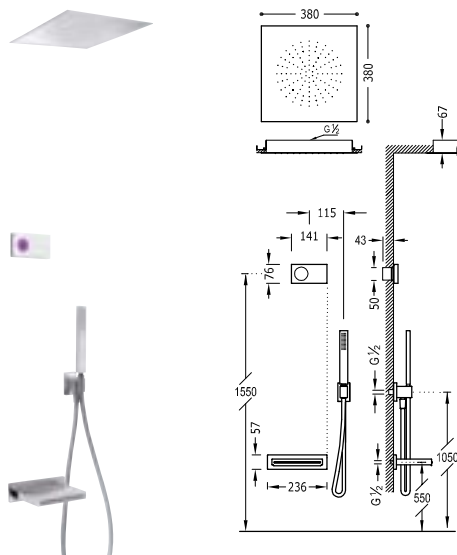

**Kit de grifo termostático electrónico empotrado de 3 vías
Shower Technology Blue Edition para bañera y ducha**

09286315



09288315NM



- Control electrónico incluido con juntas antihumedad Schlüter.
- Centralita termostática electrónica incluida (3 vías).
- Rociador de ducha empotrado a techo de acero inoxidable: 380x380 mm. IMPORTANTE: Montar un desagüe de >50 l/min.
- Caño fijo de pared con salida en cascada.
- Soporte para ducha de mano con toma de agua a pared.
- Ducha de mano anticalcárea de latón.
- Flexo satinado.



KITS DE 4 VÍAS

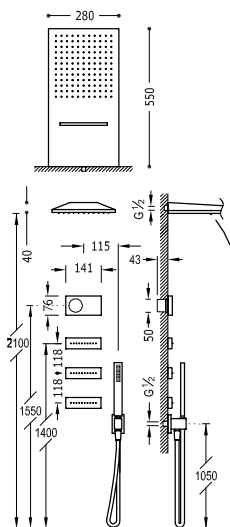

Kit de grifo termostático electrónico empotrado de 4 vías Shower Technology Blue Edition para ducha

- Control electrónico incluido con juntas antihumedad Schlüter.
- Centralita termostática electrónica incluida (4 vías).
- Rociador de ducha a pared de acero inoxidable con 2 tipos de chorro (lluvia/cascada). 280x550 mm. IMPORTANTE: Montar un desagüe de >50 l/min.
- 3 jets empotrados de hidromasaje de latón.
- Soporte para ducha de mano con toma de agua a pared.
- Ducha de mano anticalcárea de latón.
- Flexo satinado.

09286408



09288408NM

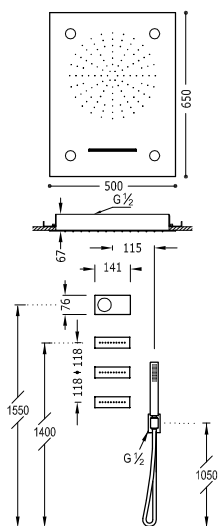

Kit de grifo termostático electrónico empotrado de 4 vías Shower Technology Blue Edition con Cromoterapia para ducha

- Control electrónico incluido con juntas antihumedad Schlüter.
- Centralita termostática electrónica incluida (4 vías).
- Rociador de ducha empotrado a techo con Cromoterapia de acero inoxidable con 2 tipos de chorro (lluvia/cascada). 500x650 mm. IMPORTANTE: Montar un desagüe de >50 l/min.
- 3 jets empotrados de hidromasaje de latón.
- Soporte para ducha de mano con toma de agua a pared.
- Ducha de mano anticalcárea de latón.
- Flexo satinado.

09286402

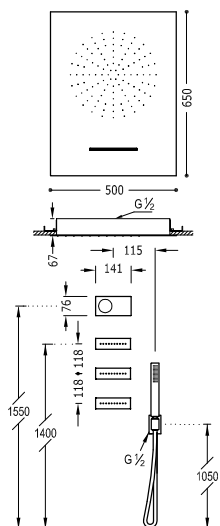

Kit de grifo termostático electrónico empotrado de 4 vías Shower Technology Blue Edition para ducha

- Control electrónico incluido con juntas antihumedad Schlüter.
- Centralita termostática electrónica incluida (4 vías).
- Rociador de ducha empotrado a techo de acero inoxidable con 2 tipos de chorro (lluvia/cascada). 500x650 mm. IMPORTANTE: Montar un desagüe de >50 l/min.
- 3 jets empotrados de hidromasaje de latón.
- Soporte para ducha de mano con toma de agua a pared.
- Ducha de mano anticalcárea de latón.
- Flexo satinado.

09286404



09288404NM



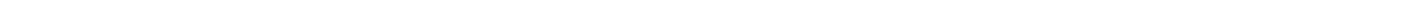



B-SYSTEM

La colección de termostáticas empotradas B-system se caracteriza por su diseño refinado de líneas sobrias con el cuerpo ligeramente separado de la pared para dar una sensación de flotabilidad. La caja empotrada interior permite una instalación más limpia y simple. B-system es elegancia y confort en la ducha.

Acabados disponibles:



CR



NM



AC



OR



OM



OP



OPM



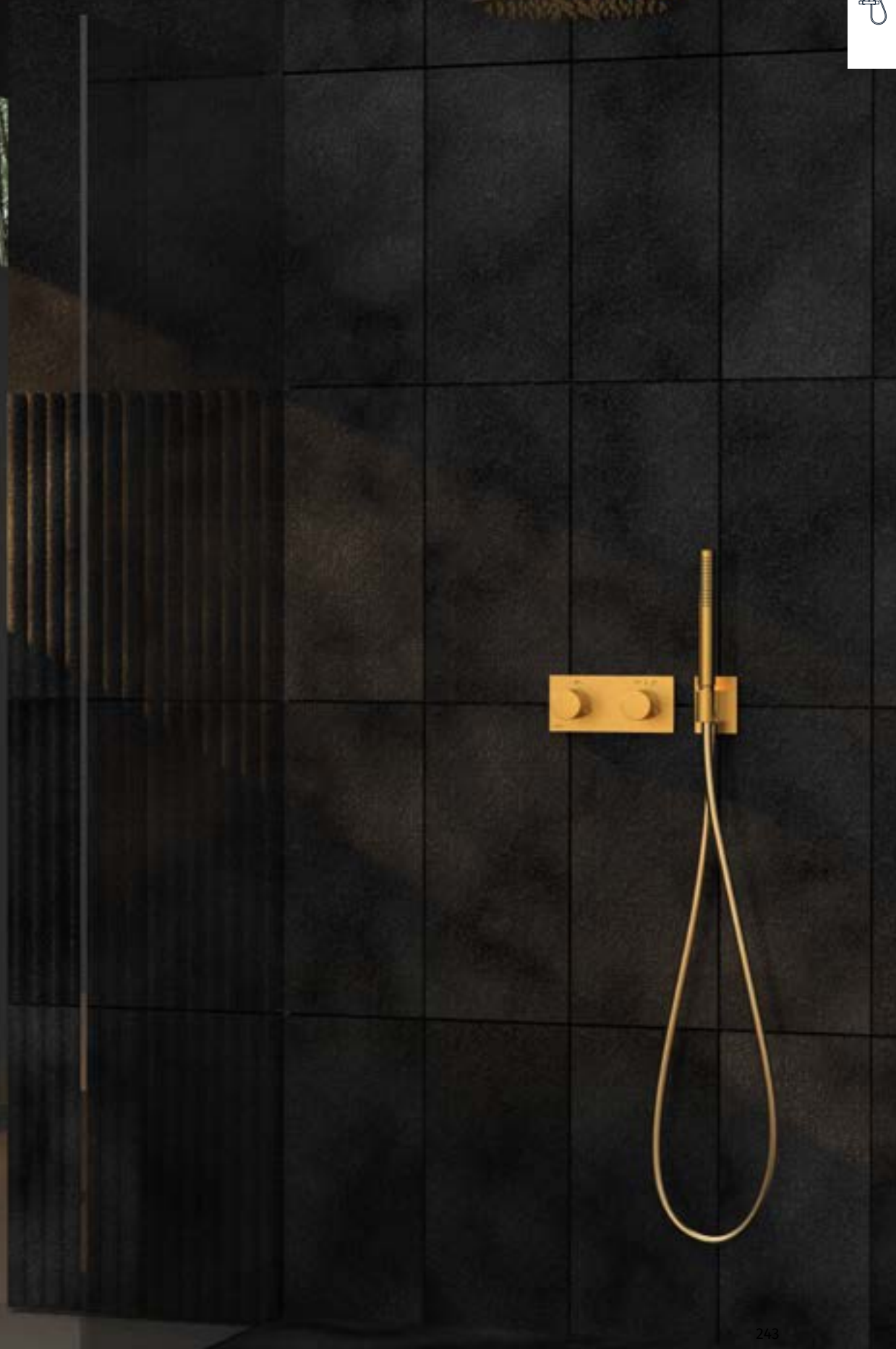

B-system

Diseñado para el placer del agua

La caja empotrada está incluida en cada pieza vista (no se suministra por separado).

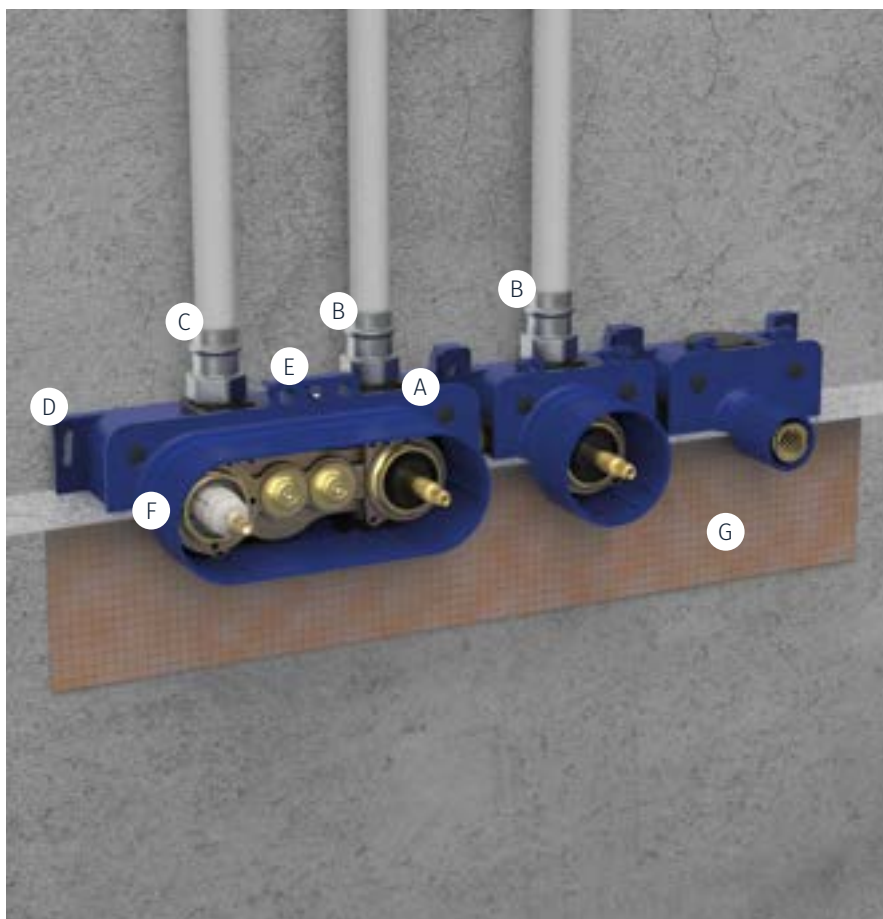

- Ⓐ Amortiguadores acústicos
- Ⓑ Salida de agua G1/2"
- Ⓒ Entrada de agua G1/2"
- Ⓓ Soportes para instalación delantera
- Ⓔ Soportes para instalación trasera
- Ⓕ Marcas de profundidad y ranuras de corte
- Ⓖ Junta de impermeabilización Schlüter®

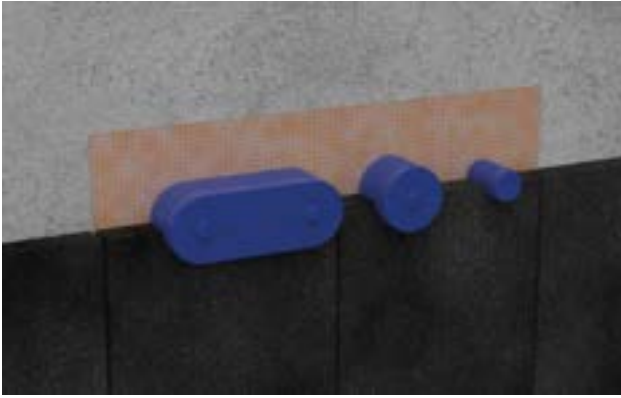

CAJA EMPOTRADA

Instalación versátil

La caja empotrada permite instalarse por delante o por detrás de la pared, tanto en paredes de obra como paredes ligeras de cartón y yeso (tipo Pladur).

Aislamiento del cuerpo

La caja aísla la transmisión de temperatura del cuerpo de latón hacia la pared. Asimismo, al ser estanca, evita que en caso de fuga el agua se filtre por la pared. La junta impermeable evita las humedades.

Bajo nivel de ruido

Los amortiguadores evitan la transmisión del ruido del grifo a la pared y a la tuberías.

Cartucho Tres Therm 77®

El cartucho garantiza un caudal de agua constante a la temperatura deseada de ± 1 grado ante variaciones de presión y/o temperatura. Concebido para la desinfección de la legionela.



PARTE VISTA

Mayor espacio en la ducha

Las piezas vistas tienen poca profundidad, permitiendo ganar más espacio útil dentro de la ducha.

Diseño ligero y refinado

El florón está ligeramente separado de la pared para dar una sensación de flotabilidad y adaptarse fácilmente a paredes irregulares. El diseño acurado aporta refinamiento y perfección en la composición del espacio de ducha.

Control preciso de la temperatura

El botón de seguridad restringe la temperatura a 38°C para evitar quemaduras. Si se desea aumentar la temperatura del agua basta con presionar el botón y girar el volante.

De 2 a 4 salidas de agua

Con un sencillo giro del distribuidor se puede escoger la salida de agua deseada.



GRIFOS TERMOSTÁTICOS EMPOTRADOS

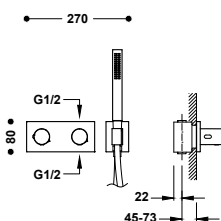

Grifo termostático empotrado de 2 vías B-system

- Cuerpo empotrado termostático de instalación horizontal incluido.
- Regulador de caudal y distribuidor cerámico de 2 vías.
- Volante redondo.
- Soporte para ducha de mano con toma de agua a pared.
- Ducha móvil anticalcárea de latón.
- Flexo satinado.

- 30735201
- 30735201NM
- 30735201AC
- 30735201OR
- 30735201OM
- 30735201OP
- 30735201OPM

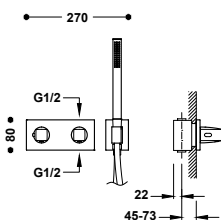

Grifo termostático empotrado de 2 vías B-system

- Cuerpo empotrado termostático de instalación horizontal incluido.
- Regulador de caudal y distribuidor cerámico de 2 vías.
- Volante cuadrado-redondo.
- Soporte para ducha de mano con toma de agua a pared.
- Ducha móvil anticalcárea de latón.
- Flexo satinado.

- 30725201
- 30725201NM
- 30725201AC
- 30725201OR
- 30725201OM
- 30725201OP
- 30725201OPM

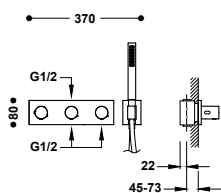

Grifo termostático empotrado de 3 vías B-system

- Cuerpo empotrado termostático de instalación horizontal incluido.
- Regulador de caudal y distribuidor de 3 vías.
- Volante redondo.
- Soporte para ducha de mano con toma de agua a pared.
- Ducha móvil anticalcárea de latón.
- Flexo satinado.

- 30735301
- 30735301NM
- 30735301AC
- 30735301OR
- 30735301OM
- 30735301OP
- 30735301OPM

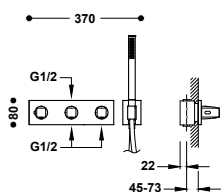

Grifo termostático empotrado de 3 vías B-system

- Cuerpo empotrado termostático de instalación horizontal incluido.
- Regulador de caudal y distribuidor de 3 vías.
- Volante cuadrado-redondo.
- Soporte para ducha de mano con toma de agua a pared.
- Ducha móvil anticalcárea de latón.
- Flexo satinado.

- 30725301
- 30725301NM
- 30725301AC
- 30725301OR
- 30725301OM
- 30725301OP
- 30725301OPM



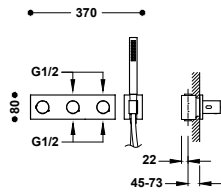

Grifo termostático empotrado de 4 vías B-system

- Cuerpo empotrado termostático de instalación horizontal incluido.
- Regulador de caudal y distribuidor de 4 vías.
- Volante redondo.
- Soporte para ducha de mano con toma de agua a pared.
- Ducha móvil anticalcárea de latón.
- Flexo satinado.

- 30735401
- 30735401NM
- 30735401AC
- 30735401OR
- 30735401OM
- 30735401OP
- 30735401OPM

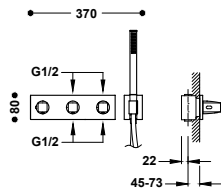

Grifo termostático empotrado de 4 vías B-system

- Cuerpo empotrado termostático de instalación horizontal incluido.
- Regulador de caudal y distribuidor de 4 vías.
- Volante cuadrado-redondo.
- Soporte para ducha de mano con toma de agua a pared.
- Ducha móvil anticalcárea de latón.
- Flexo satinado.

- 30725401
- 30725401NM
- 30725401AC
- 30725401OR
- 30725401OM
- 30725401OP
- 30725401OPM



KITS DE 2 VÍAS

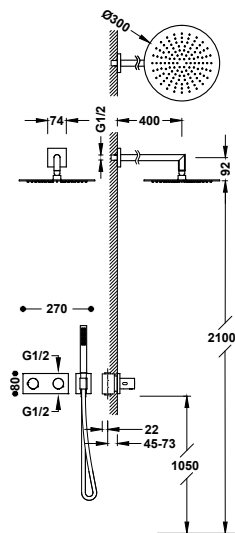

Kit de grifo termostático empotrado de 2 vías B-system para ducha

- Cuerpo empotrado termostático de instalación horizontal incluido.
- Regulador de caudal y distribuidor cerámico de 2 vías.
- Volante redondo.
- Brazo a pared con rociador de ducha orientable y de acero inoxidable: Ø 300 mm.
- Soporte para ducha de mano con toma de agua a pared.
- Ducha de mano anticalcárea de latón.
- Flexo satinado.

- 30735204
- 30735204NM
- 30735204AC
- 30735204OR
- 30735204OM
- 30735204OP
- 30735204OPM



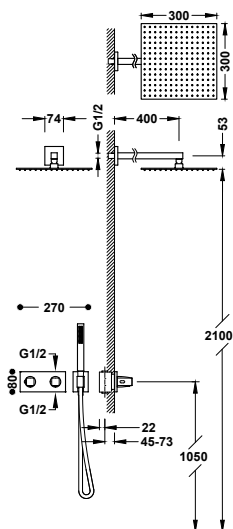

Kit de grifo termostático empotrado de 2 vías B-system para ducha

- Cuerpo empotrado termostático de instalación horizontal incluido.
- Regulador de caudal y distribuidor cerámico de 2 vías.
- Volante cuadrado-redondo.
- Brazo a pared con rociador de ducha orientable y de acero inoxidable: 300x300 mm.
- Soporte para ducha de mano con toma de agua a pared.
- Ducha de mano anticalcárea de latón.
- Flexo satinado.

- 30725204
- 30725204NM
- 30725204AC
- 30725204OR
- 30725204OM
- 30725204OP
- 30725204OPM



29926828

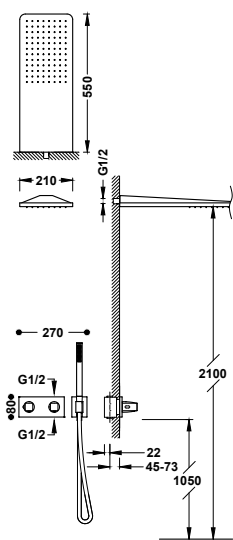

Kit de grifo termostático empotrado de 2 vías B-system para ducha

- Cuerpo empotrado termostático de instalación horizontal incluido.
- Regulador de caudal y distribuidor cerámico de 2 vías.
- Volante cuadrado-redondo.
- Rociador de ducha a pared de acero inoxidable: 210x550 mm.
- Soporte para ducha de mano con toma de agua a pared.
- Ducha de mano anticalcárea de latón.
- Flexo satinado.

- 30725205
- 30725205NM
- 30725205AC
- 30725205OR
- 30725205OM
- 30725205OP
- 30725205OPM



29926828

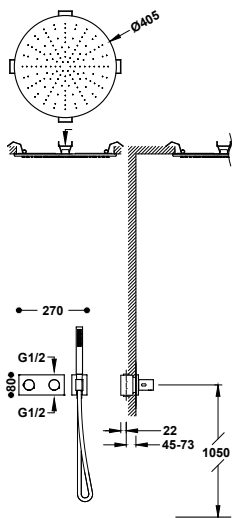

Kit de grifo termostático empotrado de 2 vías B-system para ducha

- Cuerpo empotrado termostático de instalación horizontal incluido.
- Regulador de caudal y distribuidor cerámico de 2 vías.
- Volante redondo.
- Rociador de ducha empotrado a techo de acero inoxidable: Ø 405 mm.
- Soporte para ducha de mano con toma de agua a pared.
- Ducha de mano anticalcárea de latón.
- Flexo satinado.

- 30735206
- 30735206NM
- 30735206AC
- 30735206OR
- 30735206OM
- 30735206OP
- 30735206OPM



29926828

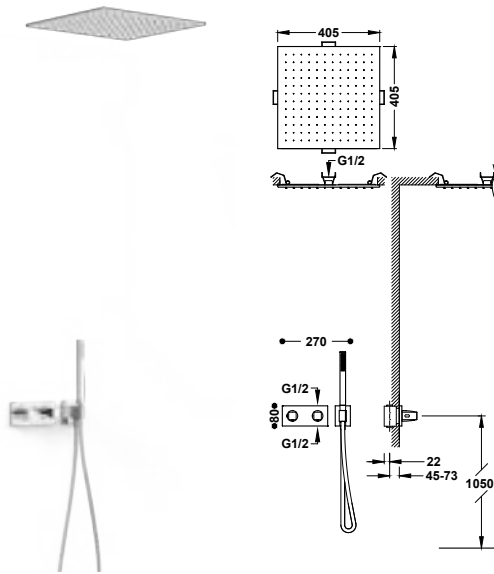

Kit de grifo termostático empotrado de 2 vías B-system para ducha

- Cuerpo empotrado termostático de instalación horizontal incluido.
- Regulador de caudal y distribuidor cerámico de 2 vías.
- Volante cuadrado-redondo.
- Rociador de ducha empotrado a techo de acero inoxidable: 405x405 mm.
- Soporte para ducha de mano con toma de agua a pared.
- Ducha de mano anticalcárea de latón.
- Flexo satinado.

- 30725206
- 30725206NM
- 30725206AC
- 30725206OR
- 30725206OM
- 30725206OP
- 30725206OPM



Kit de grifo termostático empotrado de 2 vías B-system para bañera y ducha

- Cuerpo empotrado termostático de instalación horizontal incluido.
- Regulador de caudal y distribuidor cerámico de 2 vías.
- Volante cuadrado-redondo.
- Caño fijo de pared con salida en cascada.
- Soporte para ducha de mano con toma de agua a pared.
- Ducha de mano anticalcárea de latón.
- Flexo satinado.

- 30725207
- 30725207NM
- 30725207AC
- 30725207OR
- 30725207OM
- 30725207OP
- 30725207OPM

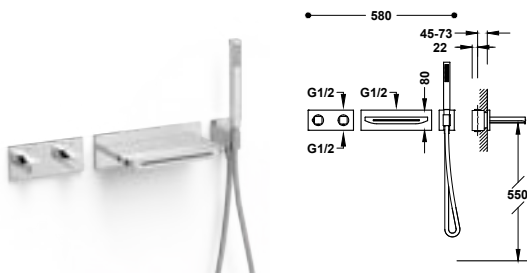

KITS DE 3 VÍAS

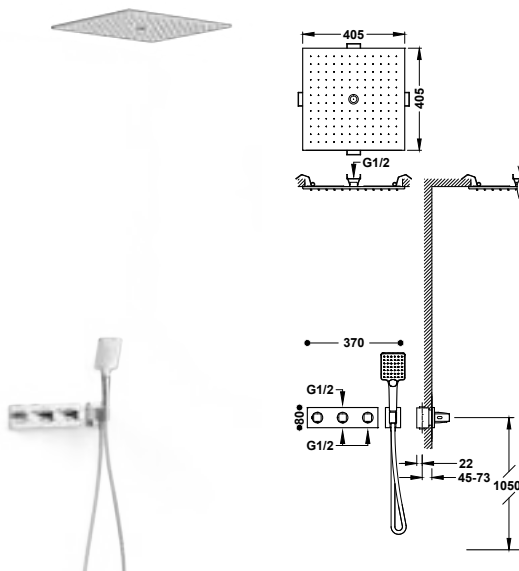

Kit de grifo termostático empotrado de 3 vías B-system para ducha

- Cuerpo empotrado termostático de instalación horizontal incluido.
- Regulador de caudal y distribuidor de 3 vías.
- Volante cuadrado-redondo.
- Rociador de ducha empotrado a techo de acero inoxidable con 2 tipos de chorro (lluvia/free flow). 405x405 mm.
- Soporte para ducha de mano con toma de agua a pared.
- Ducha de mano anticalcárea: 96x110 mm. (3 tipos de chorro).
- Flexo satinado.

- 30725306
- 30725306NM
- 30725306AC
- 30725306OR
- 30725306OM
- 30725306OP
- 30725306OPM



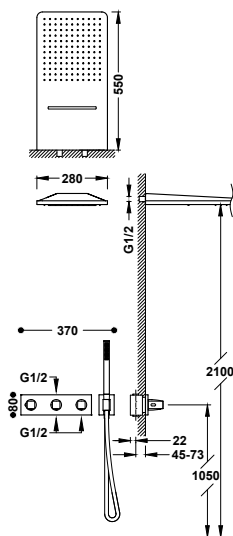

Kit de grifo termostático empotrado de 3 vías B-system para ducha

- Cuerpo empotrado termostático de instalación horizontal incluido.
- Regulador de caudal y distribuidor de 3 vías.
- Volante cuadrado-redondo.
- Rociador de ducha a pared de acero inoxidable con 2 tipos de chorro (lluvia/cascada). 280x550 mm. IMPORTANTE: Montar un desagüe de >50 l/min.
- Soporte para ducha de mano con toma de agua a pared.
- Ducha de mano anticalcárea de latón.
- Flexo satinado.

- 30725305
- 30725305NM
- 30725305AC
- 30725305OR
- 30725305OM
- 30725305OP
- 30725305OPM



KITS DE 4 VÍAS

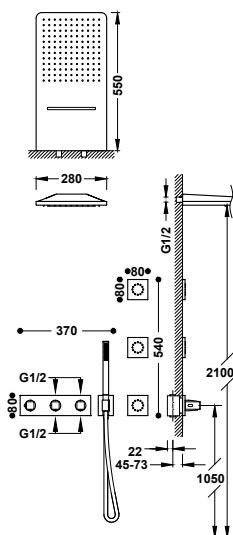

Kit de grifo termostático empotrado de 4 vías B-system para ducha

- Cuerpo empotrado termostático de instalación horizontal incluido.
- Regulador de caudal y distribuidor de 4 vías.
- Volante cuadrado-redondo.
- Rociador de ducha a pared de acero inoxidable con 2 tipos de chorro (lluvia/cascada). 280x550 mm. IMPORTANTE: Montar un desagüe de >50 l/min.
- 3 jets empotrados de hidromasaje.
- Soporte para ducha de mano con toma de agua a pared.
- Ducha de mano anticalcárea de latón.
- Flexo satinado.

- 30725405
- 30725405NM
- 30725405AC
- 30725405OR
- 30725405OM
- 30725405OP
- 30725405OPM

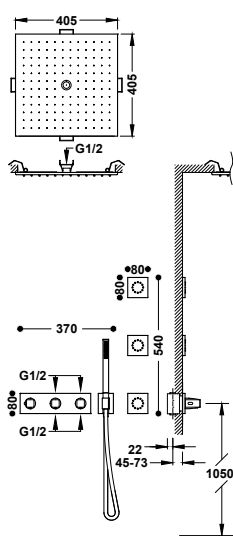

Kit de grifo termostático empotrado de 4 vías B-system para ducha

- Cuerpo empotrado termostático de instalación horizontal incluido.
- Regulador de caudal y distribuidor de 4 vías.
- Volante cuadrado-redondo.
- Rociador de ducha empotrado a techo de acero inoxidable con 2 tipos de chorro (lluvia/free flow). 405x405 mm.
- 3 jets empotrados de hidromasaje.
- Soporte para ducha de mano con toma de agua a pared.
- Ducha de mano anticalcárea de latón.
- Flexo satinado.

- 30725406
- 30725406NM
- 30725406AC
- 30725406OR
- 30725406OM
- 30725406OP
- 30725406OPM







THERM-BOX

Therm-box es el sistema empotrado de Tres para los grifos termostáticos de ducha. Control total de la temperatura con un diseño compacto. Se puede adquirir la caja empotrada y la parte vista por separado; de esta manera, la planificación de la obra se simplifica y se gana en eficacia.

Acabados disponibles:

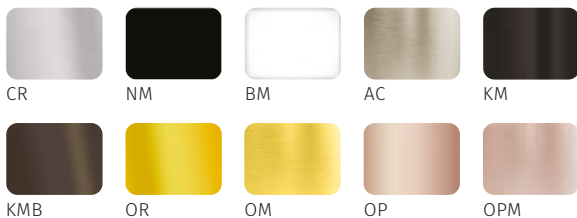



Therm-box

Un único cuerpo empotrado para los grifos termostáticos de ducha de Tres

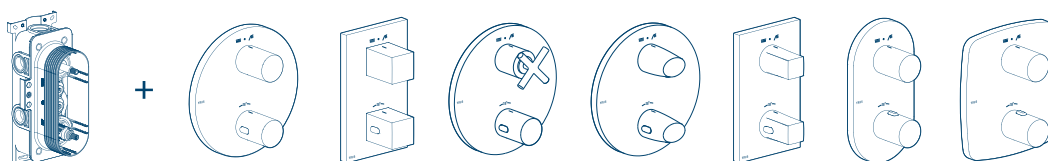

Compra e instala por separado

Puedes instalar la caja Therm-box y, posteriormente, adquirir la parte vista para instalarla cuando esté todo listo. De esta manera, la planificación de la obra se simplifica y se gana en eficacia.

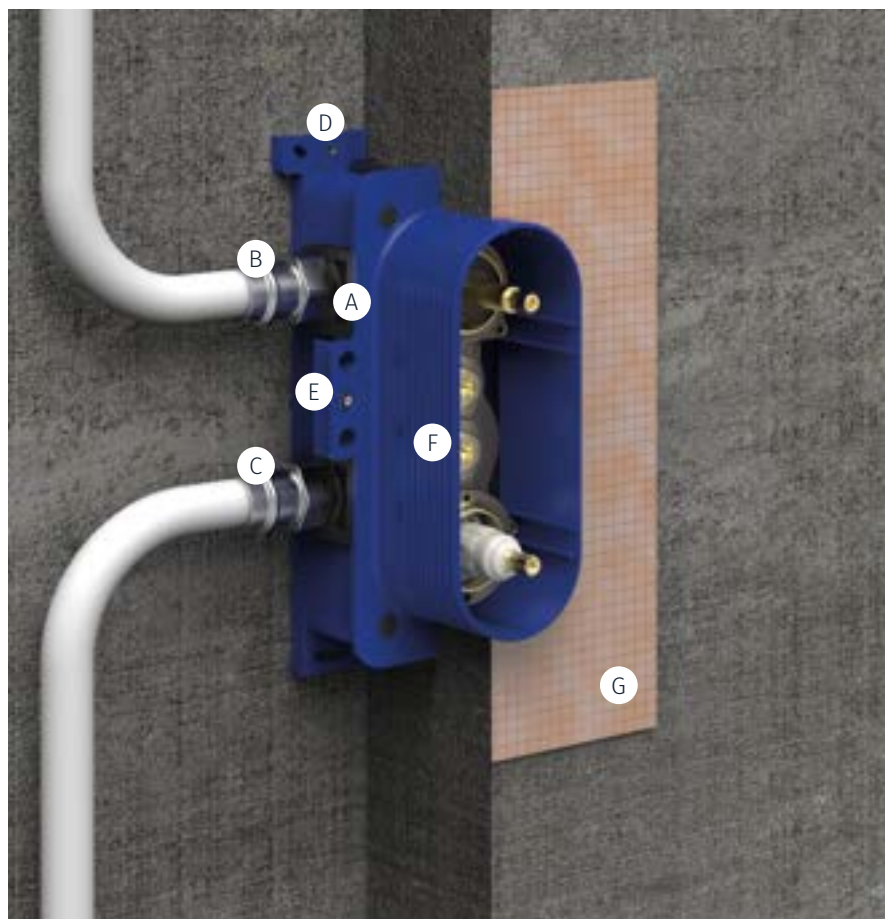

- Ⓐ Amortiguadores acústicos
- Ⓑ Salida de agua G1/2"
- Ⓒ Entrada de agua G1/2"
- Ⓓ Soportes para instalación delantera
- Ⓔ Soportes para instalación trasera
- Ⓕ Marcas de profundidad y ranuras de corte
- Ⓖ Junta de impermeabilización Schlüter®

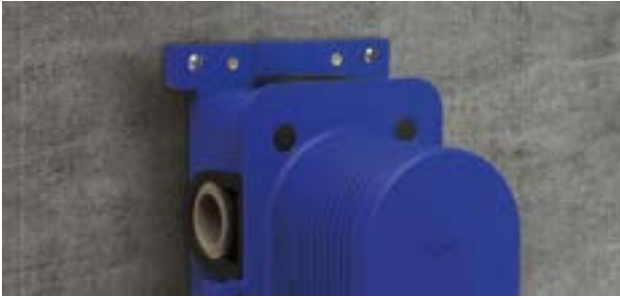

CAJA EMPOTRADA

Instalación versátil

La caja empotrada Therm-box permite instalarse por delante o por detrás de la pared, tanto en paredes de obra como paredes ligeras de cartón y yeso (tipo Pladur).

Aislamiento del cuerpo

La caja Therm-box aísla la transmisión de temperatura del cuerpo de latón hacia la pared. Asimismo, al ser estanca, evita que en caso de fuga el agua se filtre por la pared. La junta impermeable evita las humedades.

Bajo nivel de ruido

Los amortiguadores evitan la transmisión del ruido del grifo a la pared y a la tuberías.



PARTE VISTA

Mayor espacio en la ducha

Las piezas vistas tienen poca profundidad, permitiendo ganar más espacio útil dentro de la ducha.

Diseños adaptables

Las piezas vistas están disponibles en varios acabados y distintos diseños que combinan con las colecciones de Tres.

Control preciso de la temperatura

El botón de seguridad restringe la temperatura a 38°C para evitar quemaduras. Si se desea aumentar la temperatura del agua basta con presionar el botón y girar el volante.

2 salidas de agua

Con un sencillo giro del distribuidor se puede cambiar entre las 2 salidas de agua disponibles.

CAJA EMPOTRADA

Caja empotrada de 2 vías Therm-box con grifo termostático para ducha y bañera

20785001

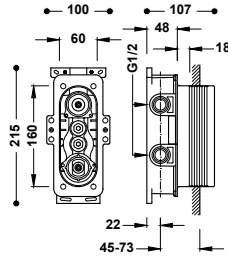

Cuerpo empotrado con amortiguadores acústicos. Caja de empotrar de ABS. Junta antihumedad. Distribuidor cerámico de 2 vías.



PIEZAS VISTAS DE 2 VÍAS

Pieza vista para caja empotrada de 2 vías Therm-box

Sólo parte vista. Volante en cruz. Incluye placa embellecedora, mando y volante distribuidor. Completar con la caja empotrada Therm-box ref.: 20785001.

28325001

- 28325001NM
- 28325001AC
- 28325001OM
- 28325001OPM

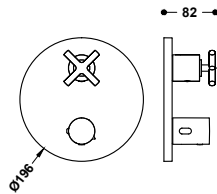

Pieza vista para caja empotrada de 2 vías Therm-box

Sólo parte vista. Volante cuadrado. Incluye placa embellecedora, mando y volante distribuidor. Completar con la caja empotrada Therm-box ref.: 20785001.

00625001

- 00625001NM
- 00625001BM
- 00625001AC
- 00625001OR
- 00625001OM

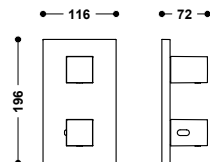

Pieza vista para caja empotrada de 2 vías Therm-box

Sólo parte vista. Volante redondo. Incluye placa embellecedora, mando y volante distribuidor. Completar con la caja empotrada Therm-box ref.: 20785001.

26225001

- 26225001NM
- 26225001BM
- 26225001AC
- 26225001KM
- 26225001KMB
- 26225001OR
- 26225001OM
- 26225001OP
- 26225001OPM

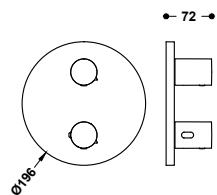

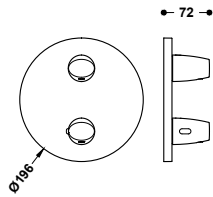

Pieza vista para caja empotrada de 2 vías Therm-box

Sólo parte vista. Volante ovalado. Incluye placa embellecedora, mando y volante distribuidor. Completar con la caja empotrada Therm-box ref.: 20785001.





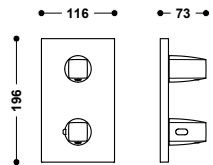





-  28125001
-  28125001NM
-  28125001AC

THERM
BOX



Pieza vista para caja empotrada de 2 vías Therm-box

Sólo parte vista. Volante cuadrado-redondo. Incluye placa embellecedora, mando y volante distribuidor. Completar con la caja empotrada Therm-box ref.: 20785001.

-  21125001
-  21125001NM
-  21125001BM
-  21125001AC
-  21125001KM
-  21125001KMB
-  21125001OR
-  21125001OM
-  21125001OP
-  21125001OPM

THERM
BOX

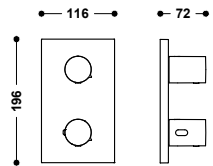

Pieza vista para caja empotrada de 2 vías Therm-box

Sólo parte vista. Volante redondo. Incluye placa embellecedora, mando y volante distribuidor. Completar con la caja empotrada Therm-box ref.: 20785001.

-  06225001

THERM
BOX

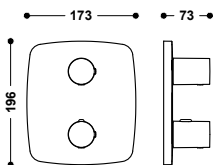

Pieza vista para caja empotrada de 2 vías Therm-box

Sólo parte vista. Volante redondo de ABS. Incluye placa embellecedora, mando y volante distribuidor. Completar con la caja empotrada Therm-box ref.: 20785001.

-  21725001

THERM
BOX

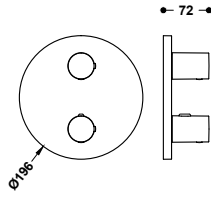

Pieza vista para caja empotrada de 2 vías Therm-box

Sólo parte vista. Volante redondo de ABS. Incluye placa embellecedora, mando y volante distribuidor. Completar con la caja empotrada Therm-box ref.: 20785001.

20425001

THERM
BOX

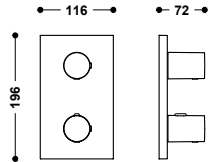

Pieza vista para caja empotrada de 2 vías Therm-box

Sólo parte vista. Volante redondo de ABS. Incluye placa embellecedora, mando y volante distribuidor. Completar con la caja empotrada Therm-box ref.: 20785001.

21625001

21625001NM

THERM
BOX

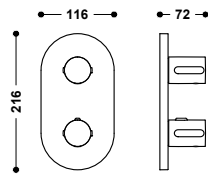

Pieza vista para caja empotrada de 2 vías Therm-box

Sólo parte vista. Volante redondo de ABS. Incluye placa embellecedora, mando y volante distribuidor. Completar con la caja empotrada Therm-box ref.: 20785001.

21525001

THERM
BOX

KITS TERMOSTÁTICOS DE 2 VÍAS

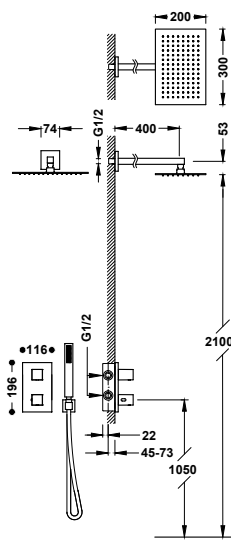

Kit de grifo termostático empotrado de 2 vías Therm-box para ducha

- Cuerpo empotrado incluido.
- Volante cuadrado con control de temperatura. Distribuidor cerámico de 2 vías.
- Brazo a pared con rociador de ducha orientable y de acero inoxidable: 300x200 mm.
- Soporte para ducha de mano con toma de agua a pared.
- Ducha de mano anticalcárea de latón.
- Flexo satinado.

- 20225054
- 20225054NM
- 20225054BM
- 20225054AC
- 20225054OR
- 20225054OM



29926828

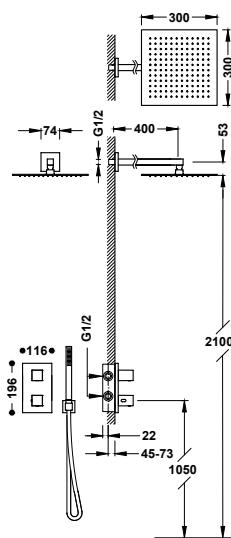

Kit de grifo termostático empotrado de 2 vías Therm-box para ducha

- Cuerpo empotrado incluido.
- Volante cuadrado con control de temperatura. Distribuidor cerámico de 2 vías.
- Brazo a pared con rociador de ducha orientable y de acero inoxidable: 300x300 mm.
- Soporte para ducha de mano con toma de agua a pared.
- Ducha de mano anticalcárea de latón.
- Flexo satinado.

- 00625004
- 00625004NM
- 00625004BM
- 00625004AC
- 00625004OR
- 00625004OM



29926828

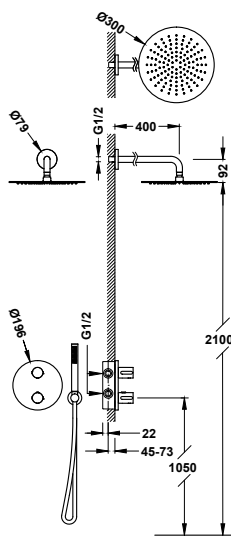

Kit de grifo termostático empotrado de 2 vías Therm-box para ducha

- Cuerpo empotrado incluido.
- Volante redondo con control de temperatura. Distribuidor cerámico de 2 vías.
- Brazo a pared con rociador de ducha orientable y de acero inoxidable: Ø 300 mm.
- Soporte para ducha de mano con toma de agua a pared.
- Ducha de mano anticalcárea de latón.
- Flexo satinado.

- 26225004
- 26225004NM
- 26225004BM
- 26225004AC
- 26225004KM
- 26225004KMB
- 26225004OR
- 26225004OM
- 26225004OP
- 26225004OPM



29926828

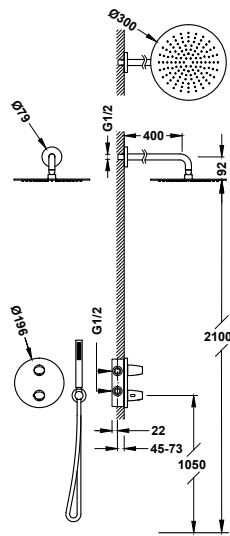

Kit de grifo termostático empotrado de 2 vías Therm-box para ducha

- Cuerpo empotrado incluido.
- Volante ovalado con control de temperatura. Distribuidor cerámico de 2 vías.
- Brazo a pared con rociador de ducha orientable y de acero inoxidable: Ø 300 mm.
- Soporte para ducha de mano con toma de agua a pared.
- Ducha de mano anticalcárea de latón.
- Flexo satinado.

28125004

28125004NM

28125004AC



29926828

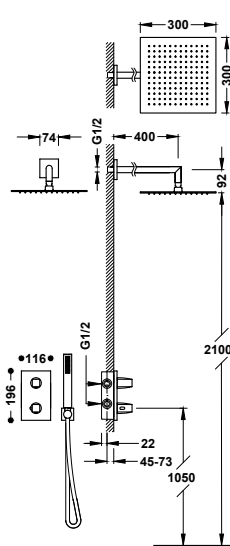

Kit de grifo termostático empotrado de 2 vías Therm-box para ducha

- Cuerpo empotrado incluido.
- Volante cuadrado-redondo con control de temperatura. Distribuidor cerámico de 2 vías.
- Brazo a pared con rociador de ducha orientable y de acero inoxidable: 300x300 mm.
- Soporte para ducha de mano con toma de agua a pared.
- Ducha de mano anticalcárea de latón.
- Flexo satinado.

21125004

21125004NM

21125004BM

21125004AC

21125004KM

21125004KMB

21125004OR

21125004OM

21125004OP

21125004OPM



29926828

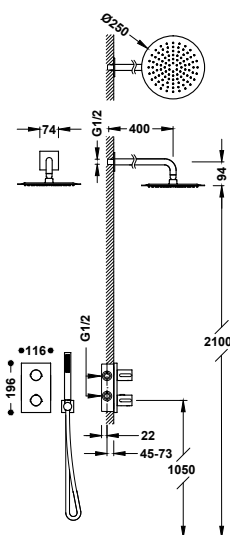

Kit de grifo termostático empotrado de 2 vías Therm-box para ducha

- Cuerpo empotrado incluido.
- Volante redondo con control de temperatura. Distribuidor cerámico de 2 vías.
- Brazo a pared con rociador de ducha orientable y de acero inoxidable: Ø 250 mm.
- Soporte para ducha de mano con toma de agua a pared.
- Ducha de mano anticalcárea de latón.
- Flexo satinado.

06225004



29926828

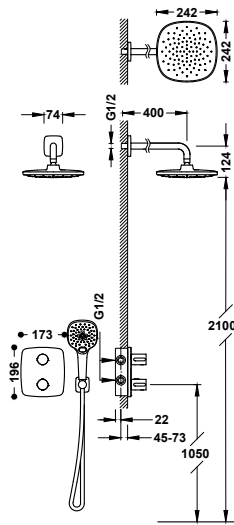

Kit de grifo termostático empotrado de 2 vías Therm-box para ducha

21725004

- Cuerpo empotrado incluido.
- Volante redondo de ABS con control de temperatura. Distribuidor cerámico de 2 vías.
- Brazo a pared con rociador de ducha orientable: 242x242 mm.
- Soporte para ducha de mano con toma de agua a pared.
- Ducha de mano anticalcárea 120x120 mm. (3 tipos de chorro).
- Flexo metálico.

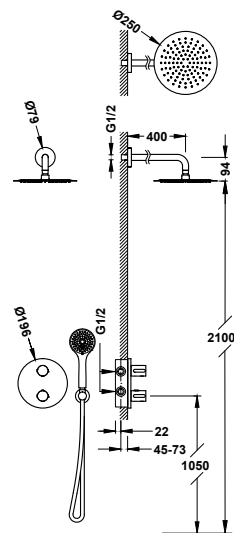

Kit de grifo termostático empotrado de 2 vías Therm-box para ducha

20425004

- Cuerpo empotrado incluido.
- Volante redondo de ABS con control de temperatura. Distribuidor cerámico de 2 vías.
- Brazo a pared con rociador de ducha orientable y de acero inoxidable: Ø 250 mm.
- Soporte para ducha de mano con toma de agua a pared.
- Ducha de mano anticalcárea: Ø 100 mm. (3 tipos de chorro).
- Flexo satinado.

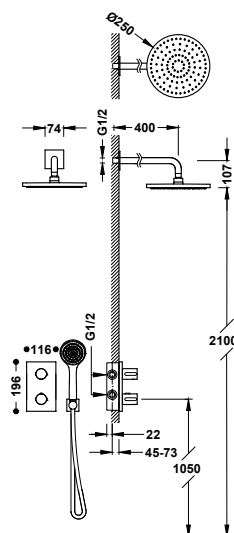

Kit de grifo termostático empotrado de 2 vías Therm-box para ducha

21625004

- Cuerpo empotrado incluido.
- Volante redondo de ABS con control de temperatura. Distribuidor cerámico de 2 vías.
- Brazo a pared con rociador de ducha orientable: Ø 250 mm.
- Soporte para ducha de mano con toma de agua a pared.
- Ducha de mano anticalcárea.
- Flexo metálico.



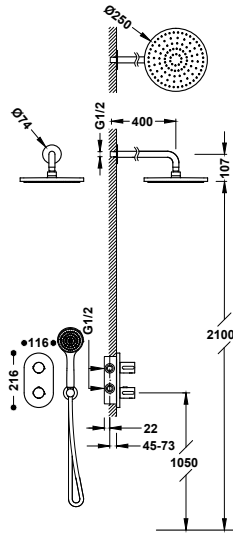

Kit de grifo termostático empotrado de 2 vías Therm-box para ducha

- Cuerpo empotrado incluido.
- Volante redondo de ABS con control de temperatura. Distribuidor cerámico de 2 vías.
- Brazo a pared con rociador de ducha orientable: Ø 250 mm.
- Soporte para ducha de mano con toma de agua a pared.
- Ducha de mano anticalcárea.
- Flexo metálico.

21525004

21525004NM

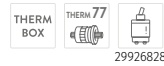

29926828

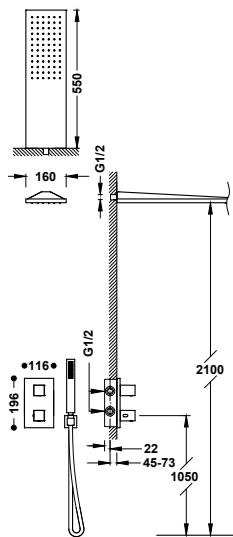

Kit de grifo termostático empotrado de 2 vías Therm-box para ducha

- Cuerpo empotrado incluido.
- Volante cuadrado con control de temperatura. Distribuidor cerámico de 2 vías.
- Rociador de ducha a pared de acero inoxidable: 160x550 mm.
- Soporte para ducha de mano con toma de agua a pared.
- Ducha de mano anticalcárea de latón.
- Flexo satinado.

20225055

20225055NM

20225055BM

20225055AC

20225055OR

20225055OM



29926828

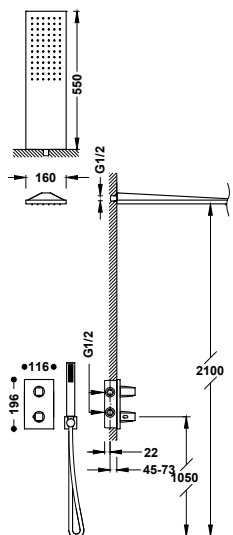

Kit de grifo termostático empotrado de 2 vías Therm-box para ducha

- Cuerpo empotrado incluido.
- Volante cuadrado-redondo con control de temperatura. Distribuidor cerámico de 2 vías.
- Rociador de ducha a pared de acero inoxidable: 160x550 mm.
- Soporte para ducha de mano con toma de agua a pared.
- Ducha de mano anticalcárea de latón.
- Flexo satinado.

21125005

21125005NM

21125005BM

21125005AC

21125005KM

21125005KMB

21125005OR

21125005OM

21125005OP

21125005OPM



29926828

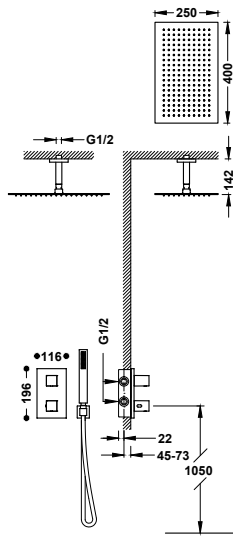

Kit de grifo termostático empotrado de 2 vías Therm-box para ducha

- Cuerpo empotrado incluido.
- Volante cuadrado con control de temperatura. Distribuidor cerámico de 2 vías.
- Brazo a techo con rociador de ducha orientable y de acero inoxidable: 400x250 mm.
- Soporte para ducha de mano con toma de agua a pared.
- Ducha de mano anticalcárea de latón.
- Flexo satinado.

- 20225053
- 20225053NM
- 20225053BM
- 20225053AC
- 20225053OR
- 20225053OM



29926828

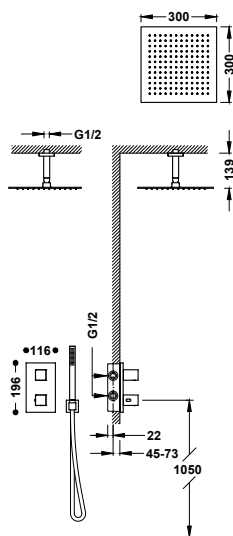

Kit de grifo termostático empotrado de 2 vías Therm-box para ducha

- Cuerpo empotrado incluido.
- Volante cuadrado con control de temperatura. Distribuidor cerámico de 2 vías.
- Brazo a techo con rociador de ducha orientable y de acero inoxidable: 300x300 mm.
- Soporte para ducha de mano con toma de agua a pared.
- Ducha de mano anticalcárea de latón.
- Flexo satinado.

- 00625003
- 00625003NM
- 00625003BM
- 00625003AC
- 00625003OR
- 00625003OM



29926828

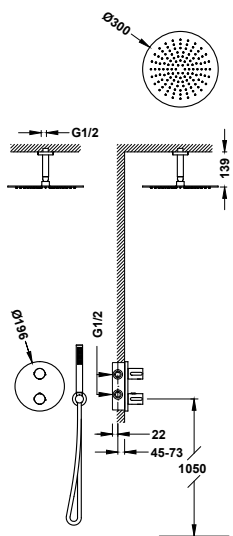

Kit de grifo termostático empotrado de 2 vías Therm-box para ducha

- Cuerpo empotrado incluido.
- Volante redondo con control de temperatura. Distribuidor cerámico de 2 vías.
- Brazo a techo con rociador de ducha orientable y de acero inoxidable: Ø 300 mm.
- Soporte para ducha de mano con toma de agua a pared.
- Ducha de mano anticalcárea de latón.
- Flexo satinado.

- 26225003
- 26225003NM
- 26225003BM
- 26225003AC
- 26225003KM
- 26225003KMB
- 26225003OR
- 26225003OM
- 26225003OP
- 26225003OPM



29926828

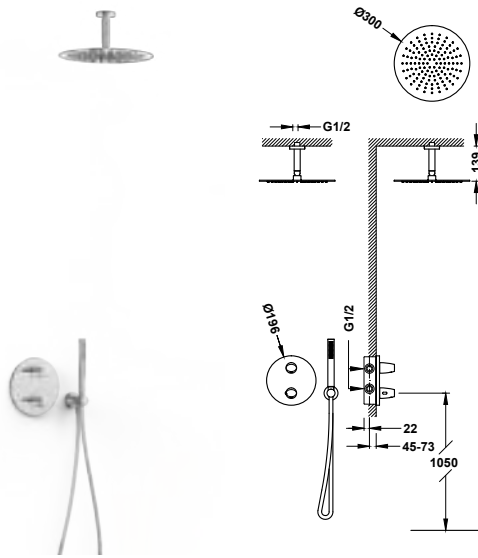

Kit de grifo termostático empotrado de 2 vías Therm-box para ducha

- Cuerpo empotrado incluido.
- Volante ovalado con control de temperatura. Distribuidor cerámico de 2 vías.
- Brazo a techo con rociador de ducha orientable y de acero inoxidable: Ø 300 mm.
- Soporte para ducha de mano con toma de agua a pared.
- Ducha de mano anticalcárea de latón.
- Flexo satinado.

28125003

- 28125003NM
- 28125003AC

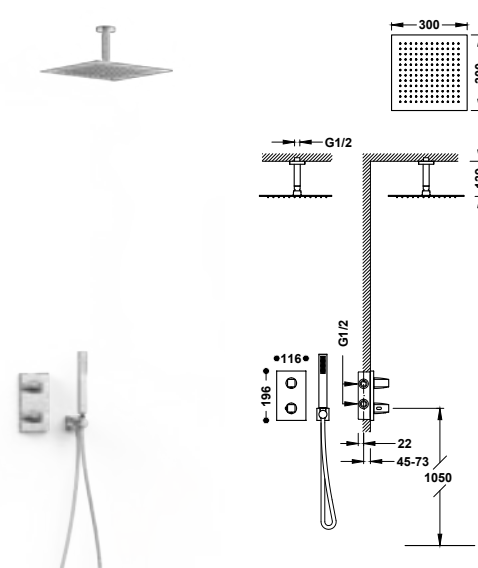

Kit de grifo termostático empotrado de 2 vías Therm-box para ducha

- Cuerpo empotrado incluido.
- Volante cuadrado-redondo con control de temperatura. Distribuidor cerámico de 2 vías.
- Brazo a techo con rociador de ducha orientable y de acero inoxidable: 300x300 mm.
- Soporte para ducha de mano con toma de agua a pared.
- Ducha de mano anticalcárea de latón.
- Flexo satinado.

21125003

- 21125003NM
- 21125003BM
- 21125003AC
- 21125003KM
- 21125003KMB
- 21125003OR
- 21125003OM
- 21125003OP
- 21125003OPM

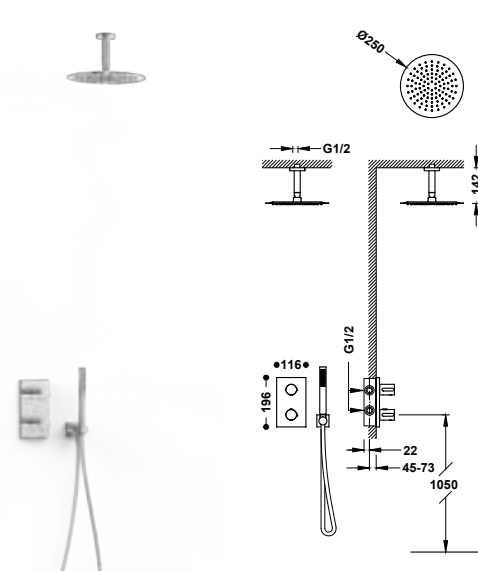

Kit de grifo termostático empotrado de 2 vías Therm-box para ducha

- Cuerpo empotrado incluido.
- Volante redondo con control de temperatura. Distribuidor cerámico de 2 vías.
- Brazo a techo con rociador de ducha orientable y de acero inoxidable: Ø 250 mm.
- Soporte para ducha de mano con toma de agua a pared.
- Ducha de mano anticalcárea de latón.
- Flexo satinado.

06225003



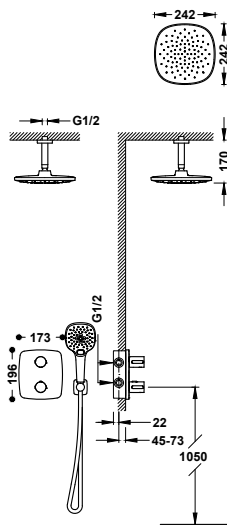

Kit de grifo termostático empotrado de 2 vías Therm-box para ducha

21725003

- Cuerpo empotrado incluido.
- Volante redondo de ABS con control de temperatura. Distribuidor cerámico de 2 vías.
- Brazo a techo con rociador de ducha orientable: 242x242 mm.
- Soporte para ducha de mano con toma de agua a pared.
- Ducha de mano anticalcárea 120x120 mm. (3 tipos de chorro).
- Flexo metálico.

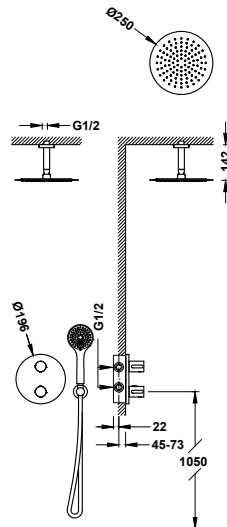

Kit de grifo termostático empotrado de 2 vías Therm-box para ducha

20425003

- Cuerpo empotrado incluido.
- Volante redondo de ABS con control de temperatura. Distribuidor cerámico de 2 vías.
- Brazo a techo con rociador de ducha orientable y de acero inoxidable: Ø 250 mm.
- Soporte para ducha de mano con toma de agua a pared.
- Ducha de mano anticalcárea: Ø 100 mm. (3 tipos de chorro).
- Flexo satinado.

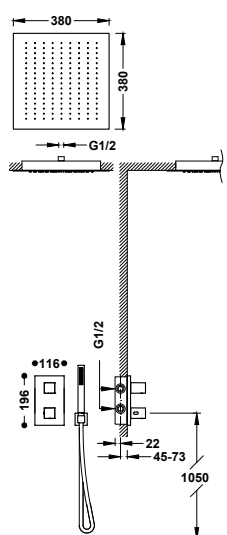

Kit de grifo termostático empotrado de 2 vías Therm-box para ducha

00625005

- Cuerpo empotrado incluido.
- Volante cuadrado con control de temperatura. Distribuidor cerámico de 2 vías.
- Rociador de ducha empotrado a techo de acero inoxidable: 380x380 mm.
- Soporte para ducha de mano con toma de agua a pared.
- Ducha de mano anticalcárea de latón.
- Flexo satinado.





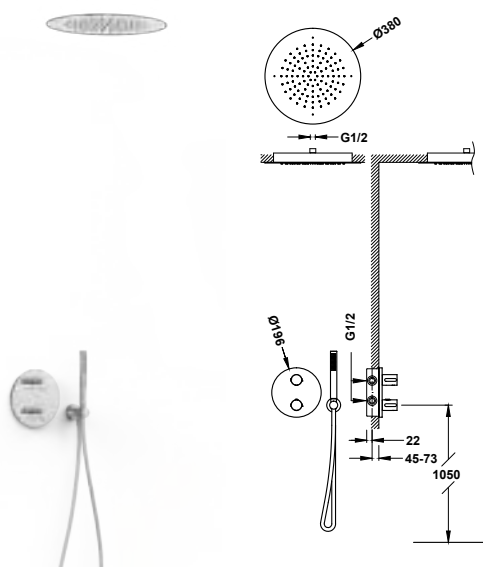





- 00625005NM
- 00625005BM
- 00625005AC
- 00625005OR
- 00625005OM





Kit de grifo termostático empotrado de 2 vías Therm-box para ducha

- Cuerpo empotrado incluido.
- Volante redondo con control de temperatura. Distribuidor cerámico de 2 vías.
- Rociador de ducha empotrado a techo de acero inoxidable: Ø 380 mm.
- Soporte para ducha de mano con toma de agua a pared.
- Ducha de mano anticalcárea de latón.
- Flexo satinado.

-  26225005
-  26225005NM
-  26225005BM
-  26225005AC
-  26225005KM
-  26225005KMB
-  26225005OR
-  26225005OM
-  26225005OP
-  26225005OPM

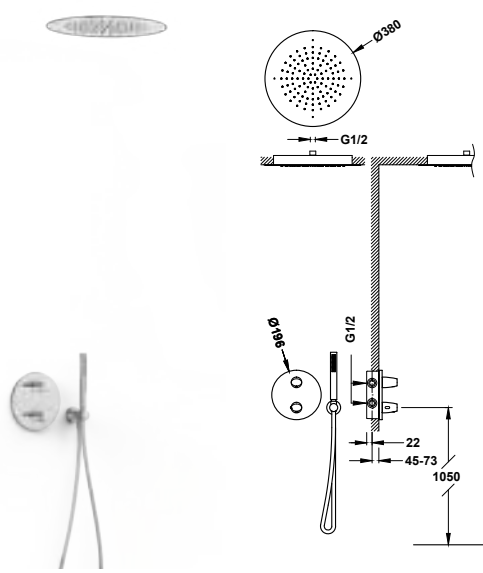

Kit de grifo termostático empotrado de 2 vías Therm-box para ducha





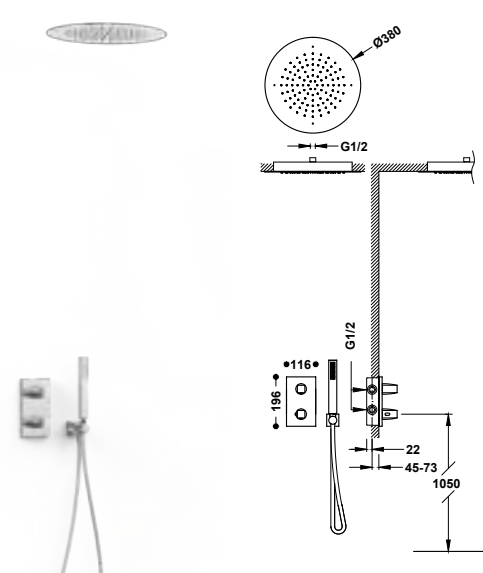





- Cuerpo empotrado incluido.
- Volante ovalado con control de temperatura. Distribuidor cerámico de 2 vías.
- Rociador de ducha empotrado a techo de acero inoxidable: Ø 380 mm.
- Soporte para ducha de mano con toma de agua a pared.
- Ducha de mano anticalcárea de latón.
- Flexo satinado.

-  28125005
-  28125005NM
-  28125005AC



Kit de grifo termostático empotrado de 2 vías Therm-box para ducha

- Cuerpo empotrado incluido.
- Volante cuadrado-redondo con control de temperatura. Distribuidor cerámico de 2 vías.
- Rociador de ducha empotrado a techo de acero inoxidable: Ø 380 mm.
- Soporte para ducha de mano con toma de agua a pared.
- Ducha de mano anticalcárea de latón.
- Flexo satinado.

-  21125006
-  21125006NM
-  21125006BM
-  21125006AC
-  21125006KM
-  21125006KMB
-  21125006OR
-  21125006OM
-  21125006OP
-  21125006OPM



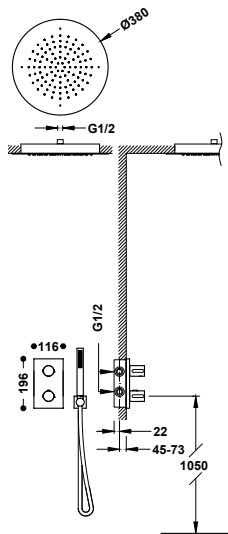

Kit de grifo termostático empotrado de 2 vías Therm-box para ducha

06225005

- Cuerpo empotrado incluido.
- Volante redondo con control de temperatura. Distribuidor cerámico de 2 vías.
- Rociador empotrado a techo de acero inoxidable: Ø 380 mm.
- Soporte para ducha de mano con toma de agua a pared.
- Ducha de mano anticalcárea de latón.
- Flexo satinado.



29926828

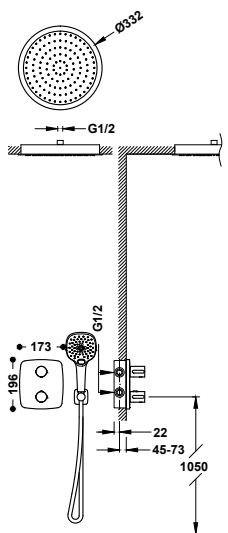

Kit de grifo termostático empotrado de 2 vías Therm-box para ducha

21725005

- Cuerpo empotrado incluido.
- Volante redondo de ABS con control de temperatura. Distribuidor cerámico de 2 vías.
- Rociador empotrado a techo de latón: Ø 332 mm.
- Soporte para ducha de mano con toma de agua a pared.
- Ducha de mano anticalcárea 120x120 mm. (3 tipos de chorro).
- Flexo metálico.

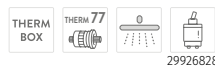

29926828

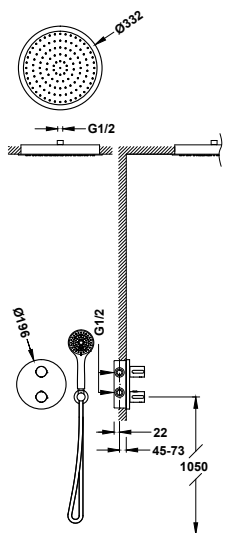

Kit de grifo termostático empotrado de 2 vías Therm-box para ducha

20425005

- Cuerpo empotrado incluido.
- Volante redondo de ABS con control de temperatura. Distribuidor cerámico de 2 vías.
- Rociador empotrado a techo de latón: Ø 332 mm.
- Soporte para ducha de mano con toma de agua a pared.
- Ducha de mano anticalcárea: Ø 100 mm. (3 tipos de chorro).
- Flexo satinado.

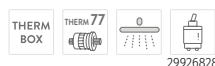

29926828

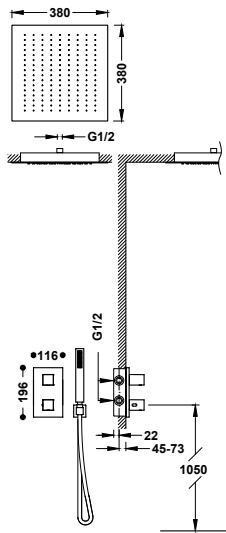

Kit de grifo termostático empotrado de 2 vías Therm-box para ducha

- Cuerpo empotrado incluido.
- Volante cuadrado con control de temperatura. Distribuidor cerámico de 2 vías.
- Rociador de ducha empotrado a techo de acero inoxidable: 380x380 mm.
- Soporte para ducha de mano con toma de agua a pared.
- Ducha de mano anticalcárea de latón.
- Flexo satinado.

- 20225056
- 20225056NM
- 20225056BM
- 20225056AC
- 20225056OR
- 20225056OM



29926828



Kit de grifo termostático empotrado de 2 vías Therm-box para bañera y ducha

- Cuerpo empotrado incluido.
- Volante cuadrado con control de temperatura. Distribuidor cerámico de 2 vías.
- Caño fijo de bañera a pared.
- Soporte para ducha de mano con toma de agua a pared.
- Ducha de mano anticalcárea de latón.
- Flexo satinado.

- 00625006
- 00625006NM
- 00625006BM
- 00625006AC
- 00625006OR
- 00625006OM

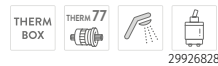
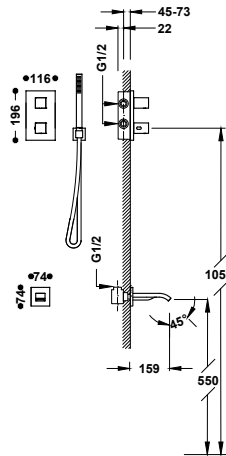

29926828



Kit de grifo termostático empotrado de 2 vías Therm-box para bañera y ducha

- Cuerpo empotrado incluido.
- Volante redondo con control de temperatura. Distribuidor cerámico de 2 vías.
- Caño fijo de bañera a pared.
- Soporte para ducha de mano con toma de agua a pared.
- Ducha de mano anticalcárea de latón.
- Flexo satinado.

- 26225006
- 26225006NM
- 26225006BM
- 26225006AC
- 26225006KM
- 26225006KMB
- 26225006OR
- 26225006OM
- 26225006OP
- 26225006OPM

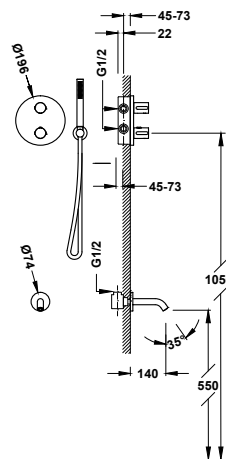

29926828



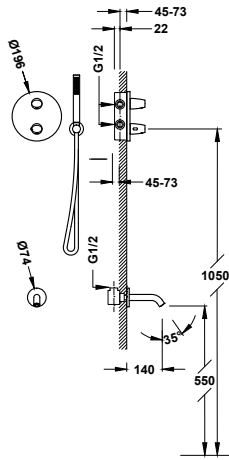

Kit de grifo termostático empotrado de 2 vías Therm-box para bañera y ducha

- Cuerpo empotrado incluido.
- Volante ovalado con control de temperatura. Distribuidor cerámico de 2 vías.
- Caño fijo de bañera a pared.
- Soporte para ducha de mano con toma de agua a pared.
- Ducha de mano anticalcárea de latón.
- Flexo satinado.

28125006

28125006NM

28125006AC

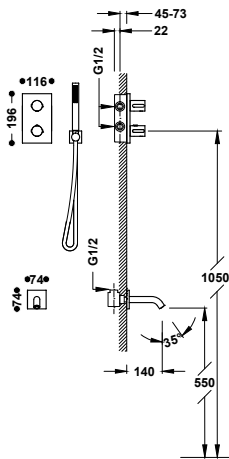

Kit de grifo termostático empotrado de 2 vías Therm-box para bañera y ducha

- Cuerpo empotrado incluido.
- Volante redondo con control de temperatura. Distribuidor cerámico de 2 vías.
- Caño fijo de bañera a pared.
- Soporte para ducha de mano con toma de agua a pared.
- Ducha de mano anticalcárea de latón.
- Flexo satinado.

06225006

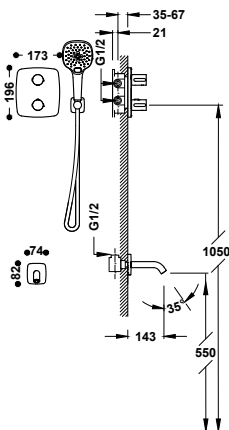

Kit de grifo termostático empotrado de 2 vías Therm-box para bañera y ducha

- Cuerpo empotrado incluido.
- Volante redondo de ABS con control de temperatura. Distribuidor cerámico de 2 vías.
- Caño fijo de bañera a pared.
- Soporte para ducha de mano con toma de agua a pared.
- Ducha de mano anticalcárea 120x120 mm. (3 tipos de chorro).
- Flexo metálico.

21725006



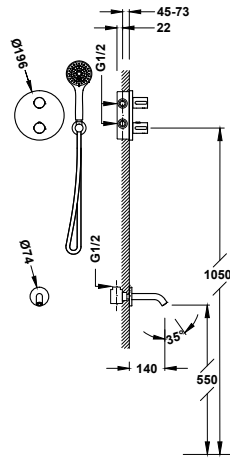

Kit de grifo termostático empotrado de 2 vías Therm-box para bañera y ducha

20425006

- Cuerpo empotrado incluido.
- Volante redondo de ABS con control de temperatura. Distribuidor cerámico de 2 vías.
- Caño fijo de bañera a pared.
- Soporte para ducha de mano con toma de agua a pared.
- Ducha de mano anticalcárea: Ø 100 mm. (3 tipos de chorro).
- Flexo satinado.

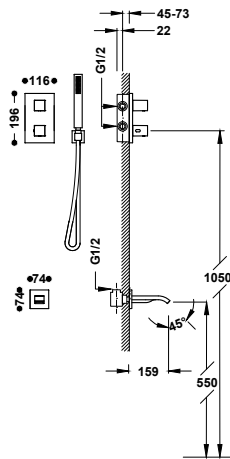

Kit de grifo termostático empotrado de 2 vías Therm-box para bañera y ducha

20225057

- Cuerpo empotrado incluido.
- Volante cuadrado con control de temperatura. Distribuidor cerámico de 2 vías.
- Caño fijo de bañera a pared.
- Soporte para ducha de mano con toma de agua a pared.
- Ducha de mano anticalcárea de latón.
- Flexo satinado.

- 20225057NM
- 20225057BM
- 20225057AC
- 20225057OR
- 20225057OM

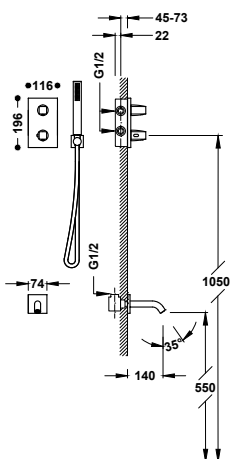

Kit de grifo termostático empotrado de 2 vías Therm-box para bañera y ducha

21125007

- Cuerpo empotrado incluido.
- Volante cuadrado-redondo con control de temperatura. Distribuidor cerámico de 2 vías.
- Caño fijo de bañera a pared.
- Soporte para ducha de mano con toma de agua a pared.
- Ducha de mano anticalcárea de latón.
- Flexo satinado.

- 21125007NM
- 21125007BM
- 21125007AC
- 21125007KM
- 21125007KMB
- 21125007OR
- 21125007OM
- 21125007OP
- 21125007OPM







OVER-WALL

La colección de termostáticas Over-wall agrupa todos los grifos termostáticos murales de Tres. Con diseños distintos que se adaptan a todos los ambientes, consiguen un control preciso de la temperatura y todas las prestaciones para una ducha agradable. Los conjuntos termostáticos Over-wall son la solución para actualizar tu ducha sin grandes reformas y con la mejor tecnología.

Acabados disponibles:



CR



NM



BM



AC



KMB



































OM









OPM





Referencia	Página	Acabados disponibles			Flexo	Rociador	Material de fabricación	Caudal (l/min)	Ducha de mano	Material de fabricación	Número de funciones	Caudal (l/min)
 19039306	284		✓		 1,5 m	300x200		12	-		1	9,5
 19039305	285		✓		 1,5 m	Ø300		12	-		1	9,5
 19038705	285		✓	✓	 1,5 m	Ø300		12	Ø110		3	8,5 2 8,5
 19038702	285		✓	✓	 1,5 m	300x300		12	96x110		3	8,5 2 8,5
 19039302	286		✓	✓	 1,5 m	Ø300		12	-		1	9,5
 19039307	286		✓	✓	 1,5 m	300x300		12	-		1	9,5



Referencia	Página	Acabados disponibles			Flexo	Rociador	Material de fabricación	Caudal (l/min)	Ducha de mano	Material de fabricación	Número de funciones	Caudal (l/min)
 19039301	286				1,7 - 2 m	Ø250		12	Ø100		1	16
 19038701	287			✓	1,5 m	Ø300		12	Ø100		1	16
 19038501	287				1,7 - 2 m	Ø250		12	Ø100		1	16
 19019601	287				1,7 - 2 m				Ø100		3	14 14 10
 21619601	288				1,7 - 2 m				Ø100		1	16
 19031202 19031205	289		✓	✓	1,7 m	Ø300 300x300		12	-		1	9,5

DESIGNED BY YOU

Tu grifo termostático Over-wall diseñado por ti y para ti. Un grifo personalizado para crear tu ducha perfecta.

Entra en la web para configurar tu grifo Over-wall

Pasos para configurar tu conjunto Over-wall

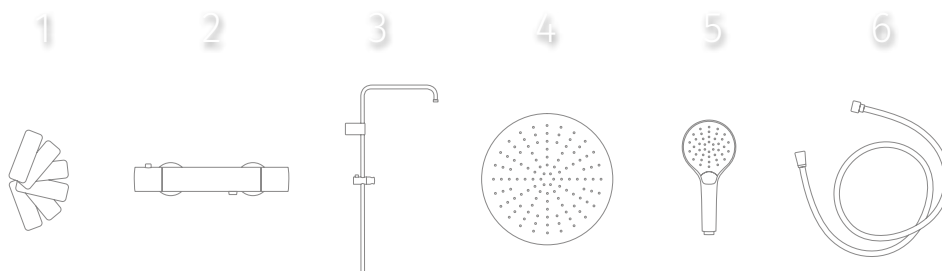

1 ACABADO

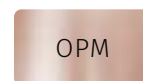
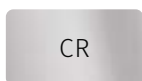

2 GRIFO TERMOSTÁTICO (PÁGINA 278)



19016906

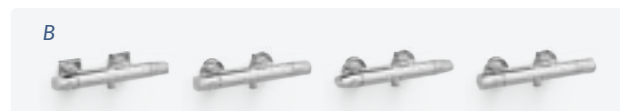

19016905

19016904

19016903

19016902

3 BARRA DE DUCHA (PÁGINA 279)



03463502

03463501

03464501

03463506

03463505



03463502

03463501

03464501

4 ROCIADOR (PÁGINA 372)

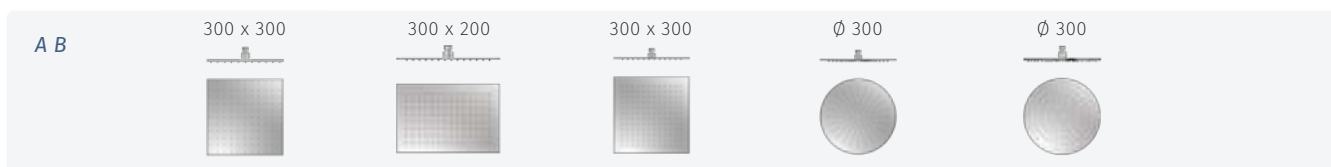

A B

300 x 300

300 x 200

300 x 300

Ø 300

Ø 300

13413830

134315007

134315012

134315010

13413730

5 DUCHA DE MANO (PÁGINA 381)

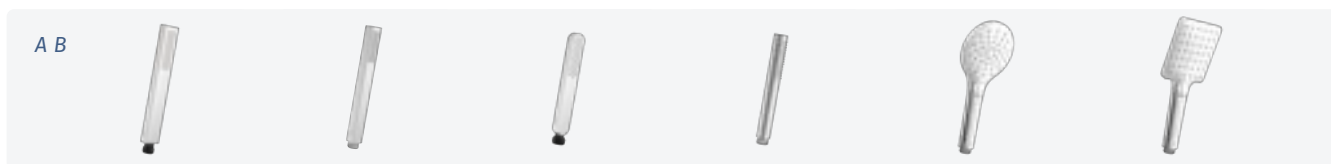

A B

20263901

00663901

03463901

03411601

29963112

29963113

6 FLEJO (PÁGINA 387)

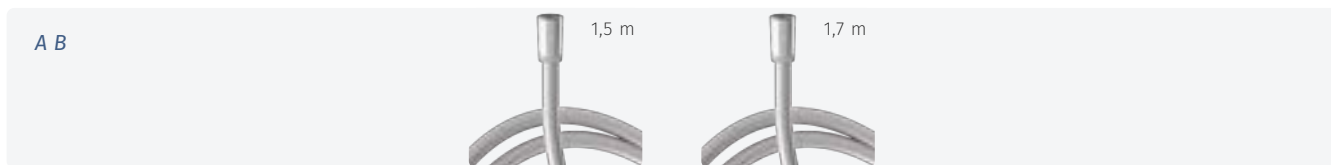

A B

1,5 m

1,7 m

913460915

9134609

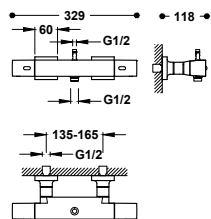

Grifo termostático mural de 2 vías Over-wall con conexión para barra de ducha

A completar con el resto de elementos de ducha. Inversor integrado en el regulador de caudal. Volante cuadrado.



29916836XX

- 19016906
- 19016906NM
- 19016906BM
- 19016906AC
- 19016906OM

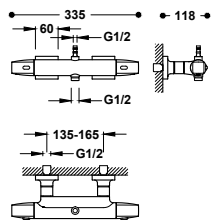

Grifo termostático mural de 2 vías Over-wall con conexión para barra de ducha

A completar con el resto de elementos de ducha. Inversor integrado en el regulador de caudal. Volante cuadrado-redondo.



29916835XX

- 19016905
- 19016905NM
- 19016905BM
- 19016905AC
- 19016905KMB
- 19016905OM
- 19016905OPM

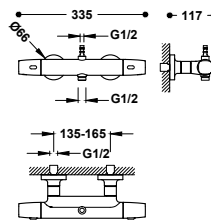

Grifo termostático mural de 2 vías Over-wall con conexión para barra de ducha

A completar con el resto de elementos de ducha. Inversor integrado en el regulador de caudal. Volante con bordes redondeados.



29916834XX

- 19016904
- 19016904NM
- 19016904BM
- 19016904AC
- 19016904KMB
- 19016904OM
- 19016904OPM

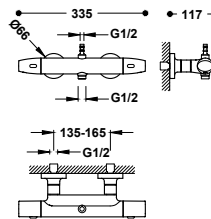

Grifo termostático mural de 2 vías Over-wall con conexión para barra de ducha

A completar con el resto de elementos de ducha. Inversor integrado en el regulador de caudal. Volante ovalado.



29916833XX

- 19016903
- 19016903NM
- 19016903BM
- 19016903AC
- 19016903KMB
- 19016903OM
- 19016903OPM

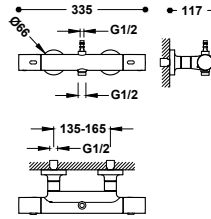

Grifo termostático mural de 2 vías Over-wall con conexión para barra de ducha

A completar con el resto de elementos de ducha. Inversor integrado en el regulador de caudal. Volante redondo.



29916832XX

- 19016902
- 19016902NM
- 19016902BM
- 19016902AC
- 19016902KMB
- 19016902OM
- 19016902OPM



Grifo termostático mural de 2 vías Over-wall con conexión para barra de ducha

A completar con el resto de elementos de ducha. Inversor integrado en el regulador de caudal. Volante redondo de ABS.

19016901

19016901NM

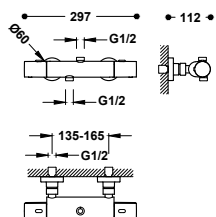

Barra de ducha adaptable a grifo termostático mural con conexión compatible

A completar con el resto de elementos de ducha.

03463502

- 03463502NM
- 03463502BM
- 03463502AC
- 03463502KMB
- 03463502OM
- 03463502OPM

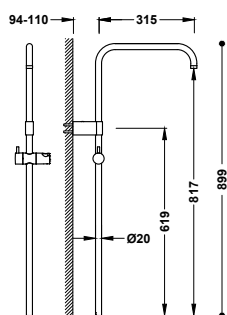

Barra de ducha larga adaptable a grifo termostático mural con conexión compatible

A completar con el resto de elementos de ducha.

03463501

- 03463501NM
- 03463501BM
- 03463501AC
- 03463501KMB
- 03463501OM
- 03463501OPM

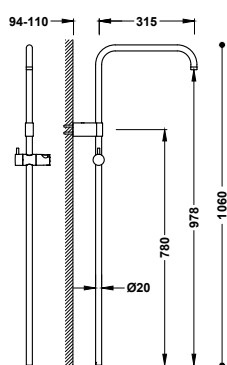

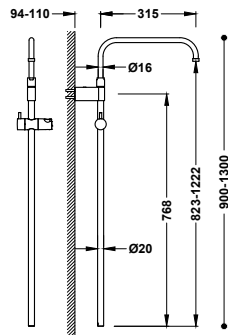

Barra de ducha telescópica adaptable a grifo termostático mural con conexión compatible

A completar con el resto de elementos de ducha.

03464501

- 03464501NM
- 03464501BM
- 03464501AC
- 03464501KMB
- 03464501OM
- 03464501OPM

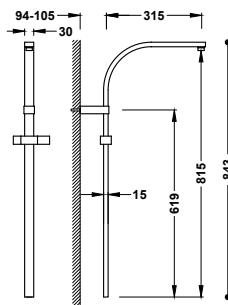

Barra de ducha adaptable a grifo termostático mural con conexión compatible

A completar con el resto de elementos de ducha.

03463506

- 03463506NM
- 03463506BM
- 03463506AC
- 03463506KMB
- 03463506OM
- 03463506OPM

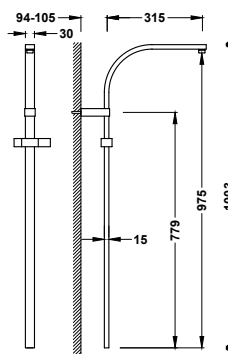

Barra de ducha larga adaptable a grifo termostático mural con conexión compatible

A completar con el resto de elementos de ducha.

03463505

- 03463505NM
- 03463505BM
- 03463505AC
- 03463505KMB
- 03463505OM
- 03463505OPM

GRIFOS TERMOSTÁTICOS PARA DUCHA

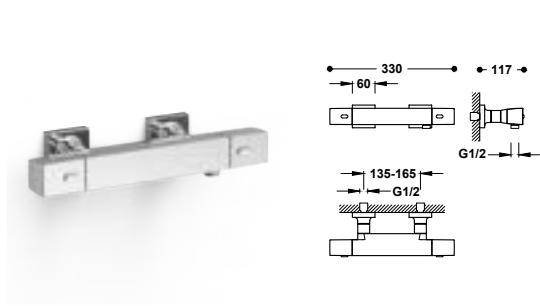

Grifo termostático mural Over-wall para ducha
Sin complementos. Volante cuadrado.

- 19016406
- 19016406NM
- 19016406BM
- 19016406AC
- 19016406OM



29916836XX

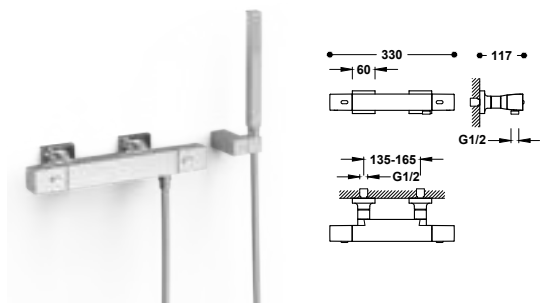

Grifo termostático mural Over-wall para ducha
Ducha de mano anticalcárea de latón. Soporte orientable para ducha de mano. Flexo satinado. Volante cuadrado.

- 19016469
- 19016469NM
- 19016469BM
- 19016469AC
- 19016469OM



29916836XX

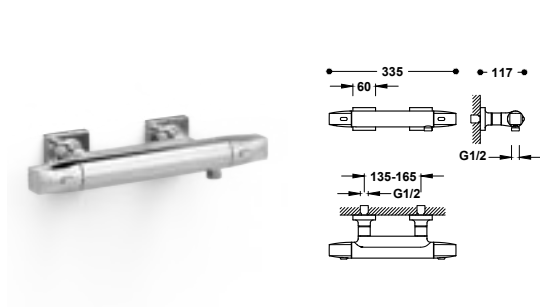

Grifo termostático mural Over-wall para ducha
Sin complementos. Volante cuadrado-redondo.

- 19016405
- 19016405NM
- 19016405BM
- 19016405AC
- 19016405KMB
- 19016405OM
- 19016405OPM



29916835XX

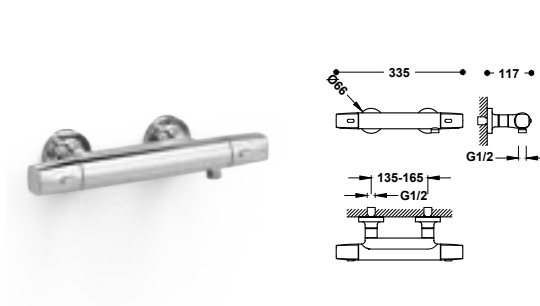

Grifo termostático mural Over-wall para ducha
Sin complementos. Volante con bordes redondeados.

- 19016404
- 19016404NM
- 19016404BM
- 19016404AC
- 19016404KMB
- 19016404OM
- 19016404OPM



29916834XX

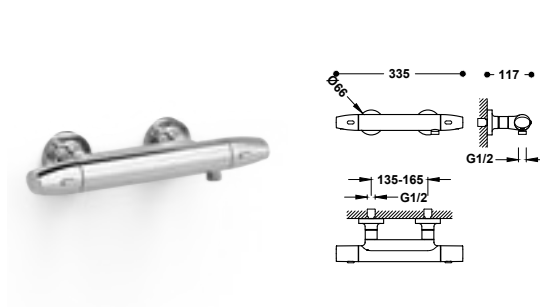

Grifo termostático mural Over-wall para ducha
Sin complementos. Volante ovalado.

- 19016403
- 19016403NM
- 19016403BM
- 19016403AC
- 19016403KMB
- 19016403OM
- 19016403OPM



29916833XX

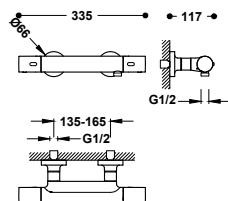

Grifo termostático mural Over-wall para ducha

Sin complementos. Volante redondo.

19016402

- 19016402NM
- 19016402BM
- 19016402AC
- 19016402KMB
- 19016402OM
- 19016402OPM



29916832XX

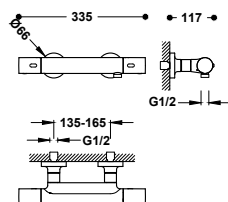

Grifo termostático mural Over-wall para ducha

Ducha de mano anticalcárea de latón. Soporte orientable para ducha de mano. Flexo satinado. Volante redondo.

19016429

- 19016429NM
- 19016429BM
- 19016429AC
- 19016429KMB
- 19016429OM
- 19016429OPM



29916832XX

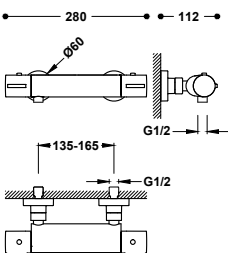

Grifo termostático mural para ducha

Sin complementos. Volante redondo de ABS.

21716401



29916803 IA

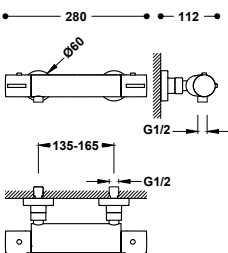

Grifo termostático mural para ducha

Ducha de mano anticalcárea 120x120 mm. (3 tipos de chorro). Soporte orientable para ducha de mano. Flexo metálico. Volante redondo de ABS.

21716409



29916803

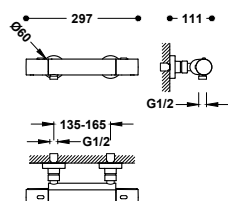

Grifo termostático mural Over-wall para ducha

Sin complementos. Volante redondo de ABS.

19016401

19016401NM



29916831XX

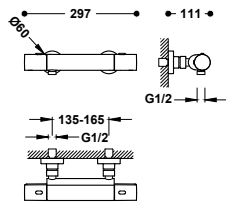

Grifo termostático mural Over-wall para ducha

Ducha de mano anticalcárea: Ø 100 mm. Soporte orientable para ducha de mano. Flexo metálico. Volante redondo de ABS.

19016419

19016419NM



GRIFOS TERMOSTÁTICOS PARA BAÑERA

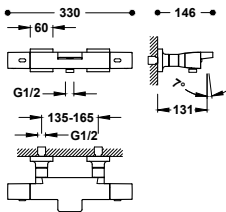

Grifo termostático mural Over-wall para bañera y ducha

Sin complementos. Inversor integrado en el regulador de caudal. Volante cuadrado.

19017406

19017406NM

19017406AC

19017406BM

19017406OM

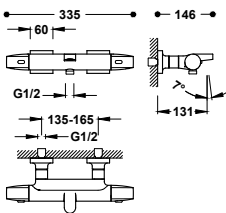

Grifo termostático mural Over-wall para bañera y ducha

Sin complementos. Inversor integrado en el regulador de caudal. Volante cuadrado-redondo.

19017405

19017405NM

19017405BM

19017405AC

19017405KMB

19017405OM

19017405OPM

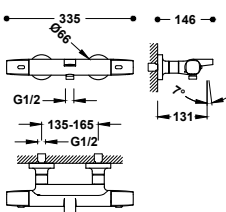

Grifo termostático mural Over-wall para bañera y ducha

Sin complementos. Inversor integrado en el regulador de caudal. Volante con bordes redondeados.

19017404

19017404NM

19017404BM

19017404AC

19017404KMB

19017404OM

19017404OPM

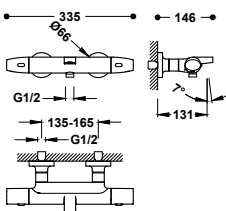

Grifo termostático mural Over-wall para bañera y ducha

Sin complementos. Inversor integrado en el regulador de caudal. Volante ovalado.

19017403

19017403NM

19017403BM

19017403AC

19017403KMB

19017403OM

19017403OPM



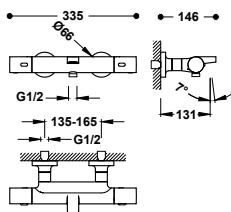

Grifo termostático mural Over-wall para bañera y ducha
Sin complementos. Inversor integrado en el regulador de caudal. Volante redondo.

- 19017402
- 19017402NM
- 19017402BM
- 19017402AC
- 19017402KMB
- 19017402OM
- 19017402OPM

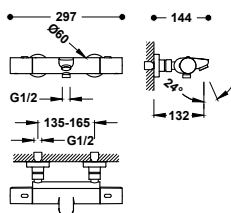

Grifo termostático mural Over-wall para bañera y ducha
Sin complementos. Inversor integrado en el regulador de caudal. Volante redondo de ABS.

- 19017401
- 19017401NM



CONJUNTOS TERMOSTÁTICOS PARA DUCHA

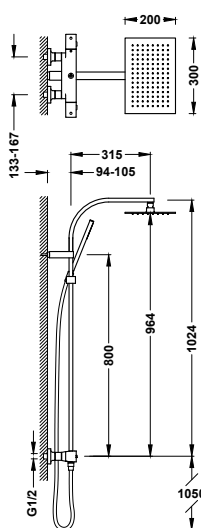

Conjunto de grifo termostático mural Over-wall de 2 vías para ducha

- Con inversor integrado en el regulador de caudal.
- Volante cuadrado.
- Rociador de ducha orientable de acero inoxidable: 300x200 mm.
- Soporte deslizante y orientable para ducha de mano.
- Ducha de mano anticalcárea de latón.
- Flexo satinado.

- 19039306
- 19039306NM
- 19039306BM
- 19039306AC
- 19039306OM



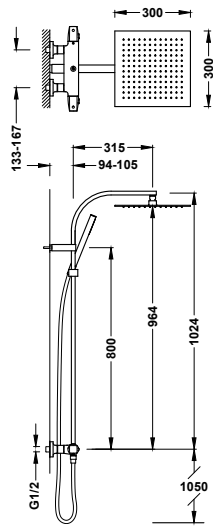

Conjunto de grifo termostático mural Over-wall de 2 vías para ducha

- Con inversor integrado en el regulador de caudal.
- Volante cuadrado-redondo.
- Rociador de ducha orientable de acero inoxidable: 300x300 mm.
- Soporte deslizante y orientable para ducha de mano.
- Ducha de mano anticalcárea de latón.
- Flexo satinado.

- 19039305
- 19039305NM
- 19039305BM
- 19039305AC
- 19039305KMB
- 19039305OM
- 19039305OPM



29916835XX

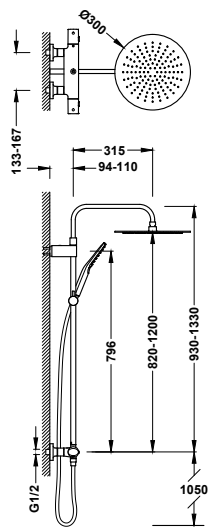

Conjunto de grifo termostático mural Over-wall de 2 vías para ducha

- Con inversor integrado en el regulador de caudal.
- Volante ovalado.
- Barra de ducha telescópica.
- Rociador de ducha orientable de acero inoxidable: Ø 300 mm.
- Soporte deslizante y orientable para ducha de mano.
- Ducha de mano anticalcárea: Ø 110 mm. (3 tipos de chorro).
- Flexo satinado.

- 19038705
- 19038705NM
- 19038705BM
- 19038705AC
- 19038705KMB
- 19038705OM
- 19038705OPM



29916833XX

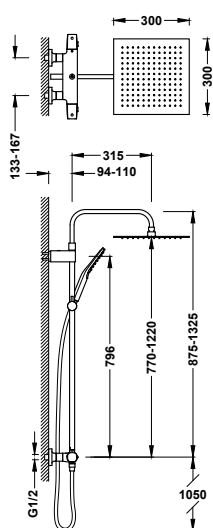

Conjunto de grifo termostático mural Over-wall de 2 vías para ducha

- Con inversor integrado en el regulador de caudal.
- Volante con bordes redondeados.
- Barra de ducha telescópica.
- Rociador de ducha orientable de acero inoxidable: 300x300 mm.
- Soporte deslizante y orientable para ducha de mano.
- Ducha de mano anticalcárea: 96x110 mm. (3 tipos de chorro).
- Flexo satinado.

- 19038702
- 19038702NM
- 19038702BM
- 19038702AC
- 19038702KMB
- 19038702OM
- 19038702OPM



29916834XX

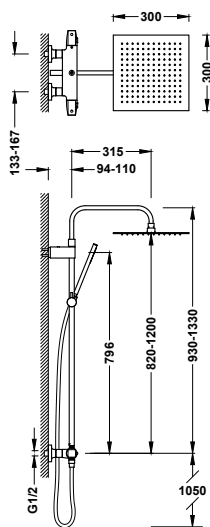

Conjunto de grifo termostático mural Over-wall de 2 vías para ducha

- Con inversor integrado en el regulador de caudal.
- Volante cuadrado-redondo.
- Barra de ducha telescópica.
- Rociador de ducha orientable de acero inoxidable: 300x300 mm.
- Soporte deslizante y orientable para ducha de mano.
- Ducha de mano anticalcárea de latón.
- Flexo satinado.

- 19039307
- 19039307NM
- 19039307BM
- 19039307AC
- 19039307KMB
- 19039307OM
- 19039307OPM



29916835XX

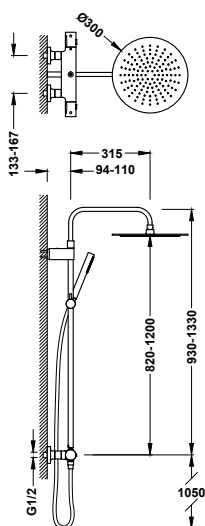

Conjunto de grifo termostático mural Over-wall de 2 vías para ducha

- Con inversor integrado en el regulador de caudal.
- Volante redondo.
- Barra de ducha telescópica.
- Rociador de ducha orientable de acero inoxidable: Ø 300 mm.
- Soporte deslizante y orientable para ducha de mano.
- Ducha de mano anticalcárea de latón.
- Flexo satinado.

- 19039302
- 19039302NM
- 19039302BM
- 19039302AC
- 19039302KMB
- 19039302OM
- 19039302OPM



29916832XX

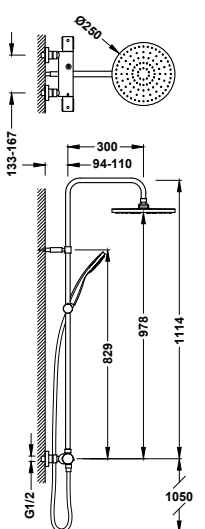

Conjunto de grifo termostático mural Over-wall de 2 vías para ducha

- Con inversor integrado en el regulador de caudal.
- Volante redondo de ABS.
- Rociador de ducha orientable: Ø 250 mm.
- Soporte deslizante y orientable para ducha de mano.
- Ducha de mano anticalcárea: Ø 100 mm.
- Flexo metálico.

- 19039301
- 19039301NM



29916831XX

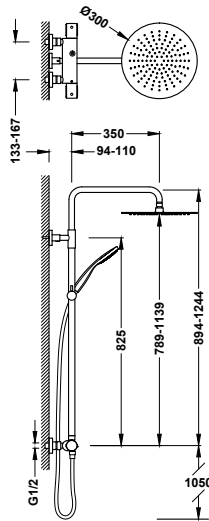

Conjunto de grifo termostático mural Over-wall de 2 vías para ducha

- Con inversor integrado en el regulador de caudal.
- Volante redondo de ABS.
- Barra de ducha telescópica.
- Rociador de ducha orientable de acero inoxidable: Ø 300 mm.
- Soporte deslizante y orientable para ducha de mano.
- Ducha de mano anticalcárea.
- Flexo metálico.

19038701

19038701NM

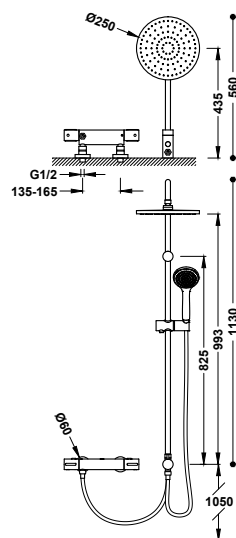

Conjunto de grifo termostático mural Over-wall de 2 vías para ducha

- Con inversor integrado en la barra de ducha.
- Volante redondo de ABS.
- Rociador de ducha orientable: Ø 250 mm.
- Soporte deslizante y orientable para ducha de mano.
- Ducha de mano anticalcárea: Ø 100 mm.
- Flexo metálico.

19038501

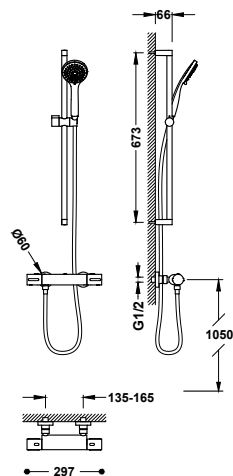

Kit de grifo termostático mural Over-wall para ducha

- Volante redondo de ABS.
- Barra de ducha: long. 673 mm y Ø 20,6 mm.
- Soporte deslizante y orientable para ducha de mano.
- Ducha de mano anticalcárea: Ø 100 mm. (3 tipos de chorro).
- Flexo metálico.

19019601



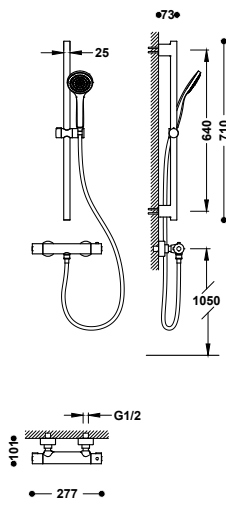

Kit de grifo termostático mural para ducha

- Barra de ducha: long. 640 mm.
- Soporte deslizante y orientable para ducha de mano.
- Ducha de mano anticalcárea: Ø 100 mm.
- Flexo metálico.

■ 21619601

■ 21619601NM

CONJUNTOS TERMOSTÁTICOS PARA BAÑERA

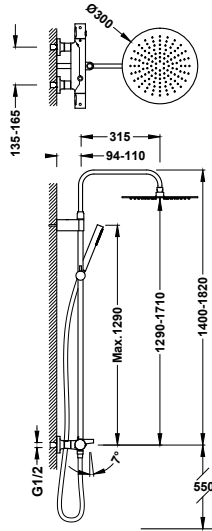

Conjunto de grifo termostático mural Over-wall de 3 vías para bañera y ducha

- Con inversor integrado en el regulador de caudal.
- Volante redondo.
- Barra de ducha telescópica.
- Rociador de ducha orientable de acero inoxidable: Ø 300 mm.
- Soporte deslizante y orientable para ducha de mano.
- Ducha de mano anticalcárea de latón.
- Flexo satinado.

- 19031202
- 19031202NM
- 19031202BM
- 19031202AC
- 19031202KMB
- 19031202OM
- 19031202OPM

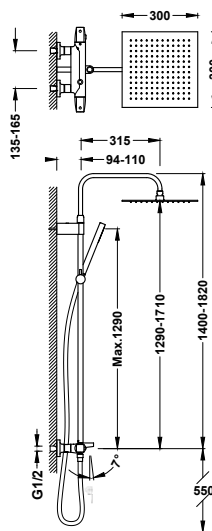

Conjunto de grifo termostático mural Over-wall de 3 vías para bañera y ducha

- Con inversor integrado en el regulador de caudal.
- Volante cuadrado-redondo.
- Barra de ducha telescópica.
- Rociador de ducha orientable de acero inoxidable: 300x300 mm.
- Soporte deslizante y orientable para ducha de mano.
- Ducha de mano anticalcárea de latón.
- Flexo satinado.

- 19031205
- 19031205NM
- 19031205BM
- 19031205AC
- 19031205KMB
- 19031205OM
- 19031205OPM



3V

Más funciones con la misma facilidad de uso. Los monomandos se caracterizan por su funcionalidad. Esta gama empotrada de monomandos no renuncia a ello y añade belleza y simplicidad en su diseño con la gran ventaja de ofrecer 3 vías distintas de salida del agua.

Acabados disponibles:





3V

Más funciones con la misma facilidad de uso



- Un único mando abre y cierra el paso del agua, ajusta la temperatura y regula el caudal.
- Un selector de funciones te permite elegir cualquiera de las tres posibles salidas del agua.
- El control y el soporte de ducha suministrados en los kits están integrados en un solo cuerpo empotrado no divisible.

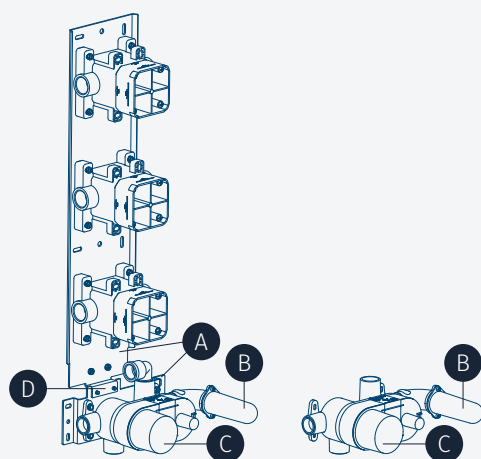

- Ⓐ Perfil de instalación a muro o pladur nivelable.
- Ⓑ Soporte con toma de ducha integrado y protector estanco.
- Ⓒ Protector extraíble. Corte exterior para proteger las partes cromadas.
- Ⓓ Alineación perfecta gracias al anclaje entre cuerpo central y jets mediante perfiles.

GRIFO MONOMANDO DE 3 VÍAS

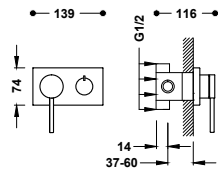

Grifo monomando empotrado de 3 vías para ducha
Con cierre y regulación de caudal. Cuerpo empotrado incluido.



21027399

21027399NM
21027399BM
21027399AC
21027399OR
21027399OM

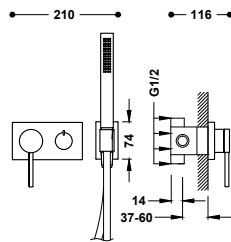

Grifo monomando empotrado de 3 vías para ducha

- Con cierre y regulación de caudal.
- Cuerpo empotrado incluido.
- Ducha móvil anticalcárea de latón.
- Soporte con toma de agua a pared.
- Flexo satinado.



21027391

21027391NM
21027391BM
21027391AC
21027391OR
21027391OM

Soporte fijo con toma de agua para ducha de mano y flexo
Con toma de agua a pared. Válvula antirretorno. Material: Latón.

20718201

20718201NM
20718201BM
20718201AC
20718201OR
20718201OM

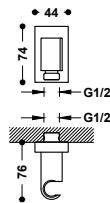

KITS DE 3 VÍAS

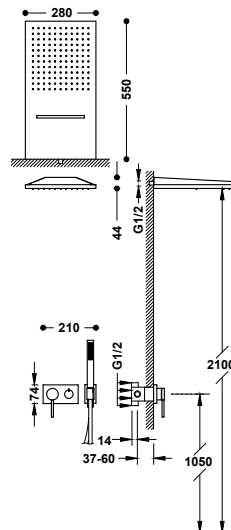

Kit de grifo monomando empotrado de 3 vías para ducha

- Con cierre y regulación de caudal.
- Cuerpo empotrado incluido.
- Rociador de ducha a pared de acero inoxidable con 2 tipos de chorro (lluvia/cascada). 280x550 mm.
- Soporte para ducha de mano con toma de agua a pared.
- Ducha de mano anticalcárea de latón.
- Flexo satinado.



21027301

21027301NM
21027301BM
21027301AC
21027301OR
21027301OM

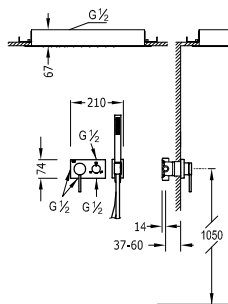
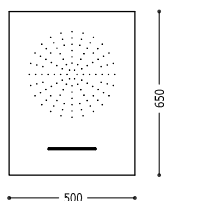

Kit de grifo monomando empotrado de 3 vías para ducha

- Con cierre y regulación de caudal.
- Cuerpo empotrado incluido.
- Rociador de ducha empotrado a techo de acero inoxidable con 2 tipos de chorro (lluvia/cascada): 500x650 mm.
- Soporte para ducha de mano con toma de agua a pared.
- Ducha de mano anticalcárea de latón.
- Flexo satinado.

- 21027303
- 21027303NM
- 21027303BM
- 21027303AC
- 21027303OR
- 21027303OM

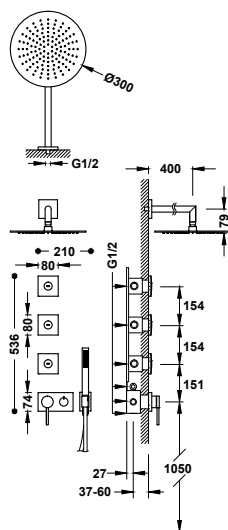

Kit de grifo monomando empotrado de 3 vías para ducha

- Con cierre y regulación de caudal.
- Cuerpo empotrado incluido.
- Brazo a pared con rociador de ducha orientable y de acero inoxidable: Ø 300 mm.
- Soporte para ducha de mano con toma de agua a pared.
- 3 jets empotrados giratorios de hidromasaje.
- Ducha de mano anticalcárea de latón.
- Flexo satinado.

- 21027304

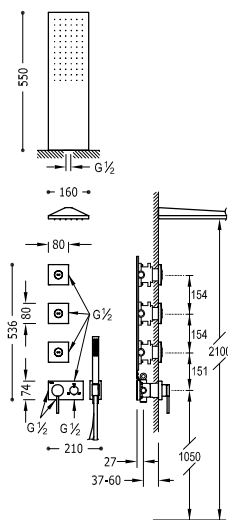

Kit de grifo monomando empotrado de 3 vías para ducha

- Con cierre y regulación de caudal.
- Cuerpo empotrado incluido.
- Rociador de ducha a pared de acero inoxidable: 160x550 mm.
- Soporte para ducha de mano con toma de agua a pared.
- 3 jets empotrados giratorios de hidromasaje.
- Ducha de mano anticalcárea de latón.
- Flexo satinado.

- 21027305



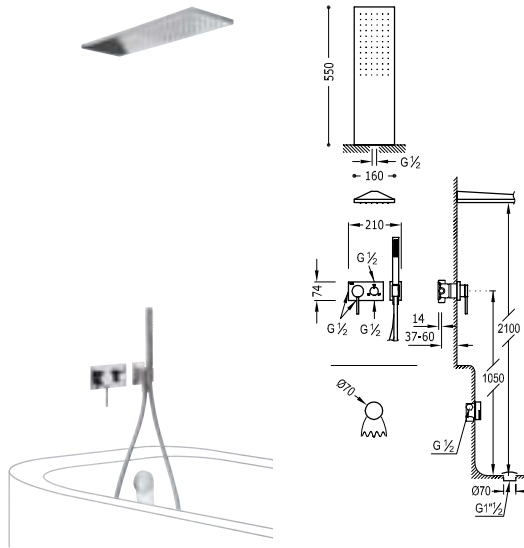

Kit de grifo monomando empotrado de 3 vías para ducha

21027312

- Con cierre y regulación de caudal.
- Cuerpo empotrado incluido.
- Rociador de ducha a pared de acero inoxidable: 160x550 mm.
- Soporte para ducha de mano con toma de agua a pared.
- Válvula de desagüe redondo Click-Clack y de llenado con rebosadero para bañera.
- Sifón PVC para bañera.
- Ducha de mano anticalcárea de latón.
- Flexo satinado.

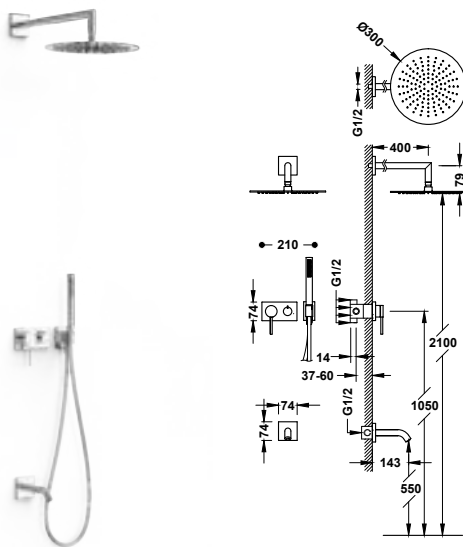

Kit de grifo monomando empotrado de 3 vías para ducha

21027313

- Con cierre y regulación de caudal.
- Cuerpo empotrado incluido.
- Brazo a pared con rociador de ducha orientable y de acero inoxidable: Ø 300 mm.
- Soporte para ducha de mano con toma de agua a pared.
- Caño fijo de bañera a pared.
- Ducha de mano anticalcárea de latón.
- Flexo satinado.

- 21027313NM
- 21027313BM
- 21027313AC







RAPID-BOX

Rapid-box es el sistema empotrado de Tres para los grifos monomando de ducha. Con diseños que combinan con todas las colecciones de Tres. Se puede adquirir la caja empotrada y la parte vista por separado; de esta manera, la planificación de la obra se simplifica y se gana en eficacia.

Acabados disponibles:

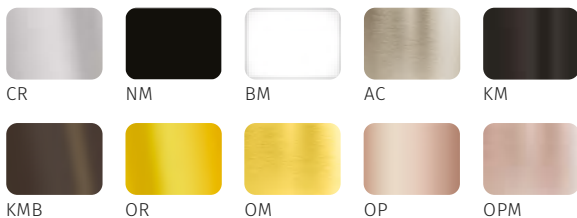



Rapid-box

Un único cuerpo empotrado para los monomandos de ducha de Tres

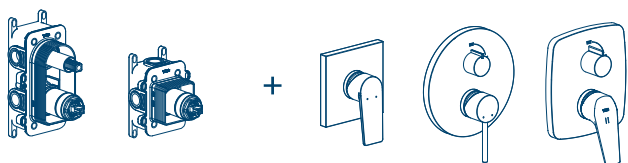

Compra e instala por separado

Puedes instalar la caja Rapid-box y, posteriormente, adquirir la parte vista para instalarla cuando esté todo listo. De esta manera, la planificación de la obra se simplifica y se gana en eficacia.

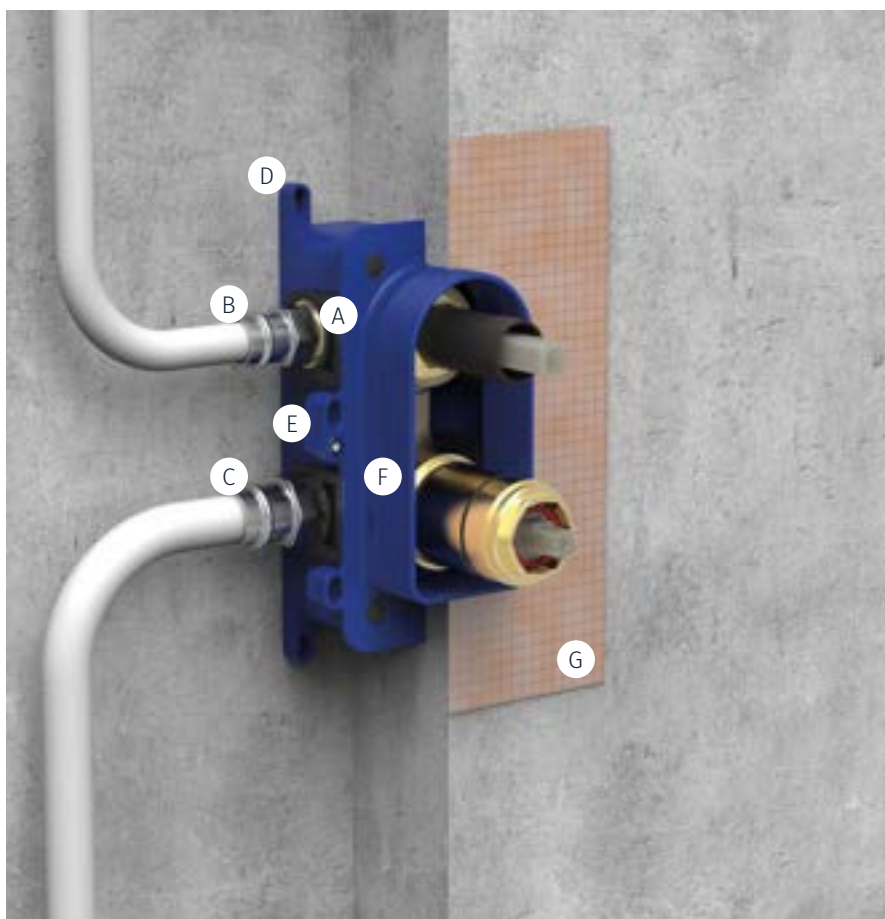

- Ⓐ Amortiguadores acústicos
- Ⓑ Salida de agua G1/2"
- Ⓒ Entrada de agua G1/2"
- Ⓓ Soportes para instalación delantera
- Ⓔ Soportes para instalación trasera
- Ⓕ Marcas de profundidad y ranuras de corte
- Ⓖ Junta de impermeabilización Schlüter®



CAJA EMPOTRADA

Instalación versátil

La caja empotrada Rapid-box permite instalarse por delante o por detrás de la pared, tanto en paredes de obra como paredes ligeras de cartón y yeso (tipo Pladur).

Aislamiento del cuerpo

La caja Rapid-box aísla la transmisión de temperatura del cuerpo de latón hacia la pared. Asimismo, al ser estanca, evita que en caso de fuga el agua se filtre por la pared. La junta impermeable evita las humedades.

Bajo nivel de ruido

Los amortiguadores evitan la transmisión del ruido del grifo a la pared y a la tuberías.



PARTE VISTA

Mayor espacio en la ducha

Las piezas vistas tienen poca profundidad, permitiendo ganar más espacio útil dentro de la ducha.

Diseños adaptables

Las piezas vistas están disponibles en varios acabados y distintos diseños que combinan con las colecciones de Tres.

Facilidad de uso

Para los monomandos de 2 vías, con un sencillo giro del distribuidor se puede cambiar entre las 2 salidas de agua disponibles.

CAJAS EMPOTRADAS

Caja empotrada de 1 vía Rapid-box con grifo monomando para ducha

20827810

Cuerpo empotrado con amortiguadores acústicos. Caja de empotrar de ABS. Junta antihumedad.

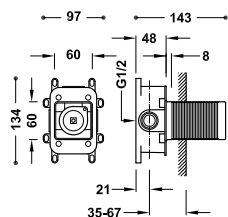

Caja empotrada de 2 vías Rapid-box con grifo monomando para ducha y bañera

20828110



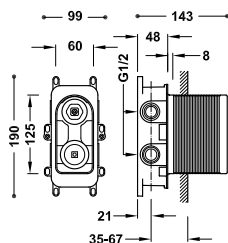



Cuerpo empotrado con amortiguadores acústicos. Caja de empotrar de ABS. Junta antihumedad. Distribuidor cerámico de 2 vías.



PIEZAS VISTAS DE 1 VÍA

Pieza vista para caja empotrada de 1 vía Rapid-box





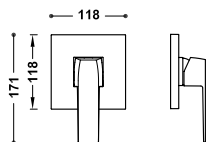

Sólo parte vista. Incluye placa embellecedora, mando, casquillo y tornillo de fijación oculto. Completar con la caja empotrada Rapid-box ref.: 20827810.

-  20227810
-  20227810NM
-  20227810BM
-  20227810AC
-  20227810OR
-  20227810OM



Pieza vista para caja empotrada de 1 vía Rapid-box

Sólo parte vista. Incluye placa embellecedora, mando, casquillo y tornillo de fijación oculto. Completar con la caja empotrada Rapid-box ref.: 20827810.

-  10627810
-  10627810NM
-  10627810BM
-  10627810AC
-  10627810OR
-  10627810OM

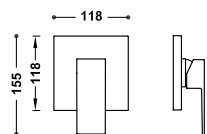

Pieza vista para caja empotrada de 1 vía Rapid-box

Sólo parte vista. Incluye placa embellecedora, mando, casquillo y tornillo de fijación oculto. Completar con la caja empotrada Rapid-box ref.: 20827810.

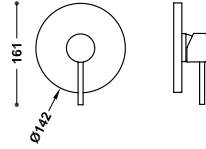

RAPID BOX

- 26227810
- 26227810NM
- 26227810BM
- 26227810AC
- 26227810KM
- 26227810KMB
- 26227810OR
- 26227810OM
- 26227810OP
- 26227810OPM



Pieza vista para caja empotrada de 1 vía Rapid-box

Sólo parte vista. Incluye placa embellecedora, mando, casquillo y tornillo de fijación oculto. Completar con la caja empotrada Rapid-box ref.: 20827810.

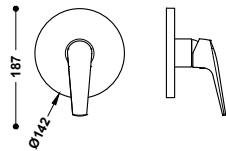

RAPID BOX

- 28127810
- 28127810NM
- 28127810AC

Pieza vista para caja empotrada de 1 vía Rapid-box

Sólo parte vista. Incluye placa embellecedora, mando, casquillo y tornillo de fijación oculto. Completar con la caja empotrada Rapid-box ref.: 20827810.

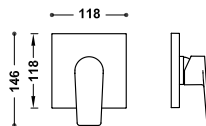

RAPID BOX

- 21127810
- 21127810NM
- 21127810BM
- 21127810AC
- 21127810KM
- 21127810KMB
- 21127810OR
- 21127810OM
- 21127810OP
- 21127810OPM

Pieza vista para caja empotrada de 1 vía Rapid-box

Sólo parte vista. Incluye placa embellecedora, mando, casquillo y tornillo de fijación oculto. Completar con la caja empotrada Rapid-box ref.: 20827810.

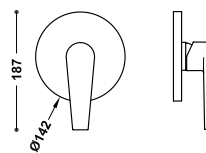

RAPID BOX

- 20527810

Pieza vista para caja empotrada de 1 vía Rapid-box

06227810

Sólo parte vista. Incluye placa embellecedora, mando, casquillo y tornillo de fijación oculto. Completar con la caja empotrada Rapid-box ref.: 20827810.

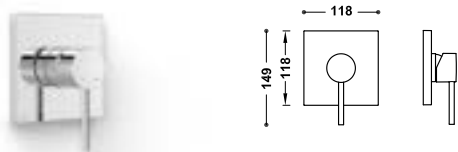

RAPID
BOX

Pieza vista para caja empotrada de 1 vía Rapid-box

21827810

Sólo parte vista. Incluye placa embellecedora, mando, casquillo y tornillo de fijación oculto. Completar con la caja empotrada Rapid-box ref.: 20827810.

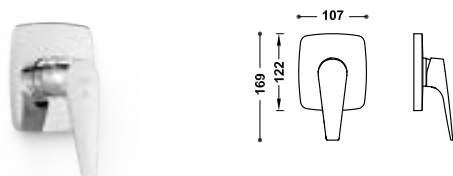

RAPID
BOX

Pieza vista para caja empotrada de 1 vía Rapid-box

21727810

Sólo parte vista. Incluye placa embellecedora, mando, casquillo y tornillo de fijación oculto. Completar con la caja empotrada Rapid-box ref.: 20827810.

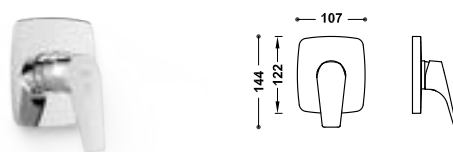

RAPID
BOX

Pieza vista para caja empotrada de 1 vía Rapid-box

20427810

Sólo parte vista. Incluye placa embellecedora, mando, casquillo y tornillo de fijación oculto. Completar con la caja empotrada Rapid-box ref.: 20827810.

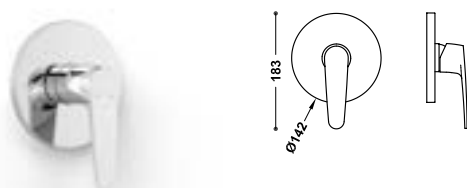

RAPID
BOX

Pieza vista para caja empotrada de 1 vía Rapid-box

■ 21627810

Sólo parte vista. Incluye placa embellecedora, mando, casquillo y tornillo de fijación oculto. Completar con la caja empotrada Rapid-box ref.: 20827810.

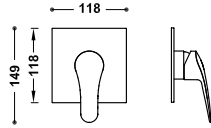

RAPID
BOX



Pieza vista para caja empotrada de 1 vía Rapid-box

■ 21527810

Sólo parte vista. Incluye placa embellecedora, mando, casquillo y tornillo de fijación oculto. Completar con la caja empotrada Rapid-box ref.: 20827810.

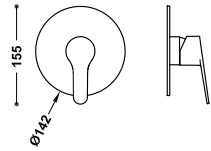

RAPID
BOX

PIEZAS VISTAS DE 2 VÍAS

Pieza vista para caja empotrada de 2 vías Rapid-box

■ 20228110

Sólo parte vista. Incluye placa embellecedora, mando, volante distribuidor y tornillo de fijación oculto. Completar con la caja empotrada Rapid-box ref.: 20828110.

- 20228110NM
- 20228110BM
- 20228110AC
- 20228110OR
- 20228110OM

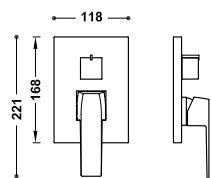





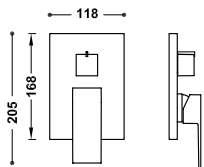

RAPID
BOX

Pieza vista para caja empotrada de 2 vías Rapid-box

Sólo parte vista. Incluye placa embellecedora, mando, volante distribuidor y tornillo de fijación oculto. Completar con la caja empotrada Rapid-box ref.: 20828110.









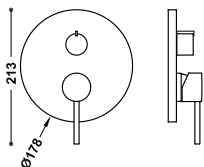

-  10628110
-  10628110NM
-  10628110BM
-  10628110AC
-  10628110OR
-  10628110OM

Pieza vista para caja empotrada de 2 vías Rapid-box

Sólo parte vista. Incluye placa embellecedora, mando, volante distribuidor y tornillo de fijación oculto. Completar con la caja empotrada Rapid-box ref.: 20828110.





-  26228110
-  26228110NM
-  26228110BM
-  26228110AC
-  26228110KM
-  26228110KMB
-  26228110OR
-  26228110OM
-  26228110OP
-  26228110OPM

Pieza vista para caja empotrada de 2 vías Rapid-box

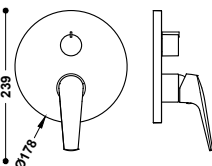
Sólo parte vista. Incluye placa embellecedora, mando, volante distribuidor y tornillo de fijación oculto. Completar con la caja empotrada Rapid-box ref.: 20828110.









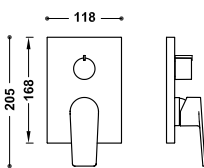

-  28128110
-  28128110NM
-  28128110AC

Pieza vista para caja empotrada de 2 vías Rapid-box

Sólo parte vista. Incluye placa embellecedora, mando, volante distribuidor y tornillo de fijación oculto. Completar con la caja empotrada Rapid-box ref.: 20828110.



-  21128110
-  21128110NM
-  21128110BM
-  21128110AC
-  21128110KM
-  21128110KMB
-  21128110OR
-  21128110OM
-  21128110OP
-  21128110OPM

Pieza vista para caja empotrada de 2 vías Rapid-box

20528110

Sólo parte vista. Incluye placa embellecedora, mando, volante distribuidor y tornillo de fijación oculto. Completar con la caja empotrada Rapid-box ref.: 20828110.

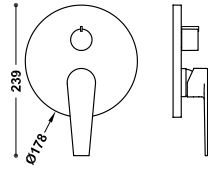

RAPID
BOX



Pieza vista para caja empotrada de 2 vías Rapid-box

06228110

Sólo parte vista. Incluye placa embellecedora, mando, volante distribuidor y tornillo de fijación oculto. Completar con la caja empotrada Rapid-box ref.: 20828110.

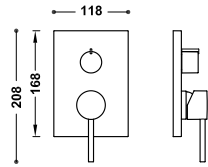

RAPID
BOX

Pieza vista para caja empotrada de 2 vías Rapid-box

21828110

Sólo parte vista. Incluye placa embellecedora, mando, volante distribuidor y tornillo de fijación oculto. Completar con la caja empotrada Rapid-box ref.: 20828110.

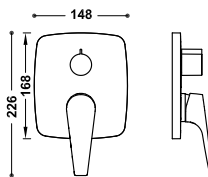

RAPID
BOX

Pieza vista para caja empotrada de 2 vías Rapid-box

21728110

Sólo parte vista. Incluye placa embellecedora, mando, volante distribuidor y tornillo de fijación oculto. Completar con la caja empotrada Rapid-box ref.: 20828110.

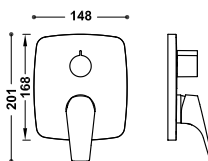

RAPID
BOX

Pieza vista para caja empotrada de 2 vías Rapid-box

20428110

Sólo parte vista. Incluye placa embellecedora, mando, volante distribuidor y tornillo de fijación oculto. Completar con la caja empotrada Rapid-box ref.: 20828110.

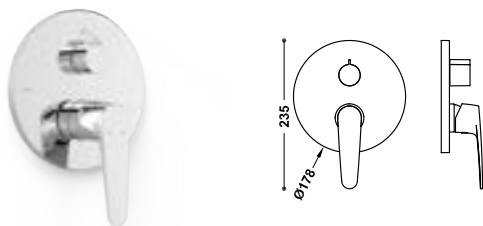

RAPID
BOX

Pieza vista para caja empotrada de 2 vías Rapid-box

21628110

Sólo parte vista. Incluye placa embellecedora, mando, volante distribuidor y tornillo de fijación oculto. Completar con la caja empotrada Rapid-box ref.: 20828110.

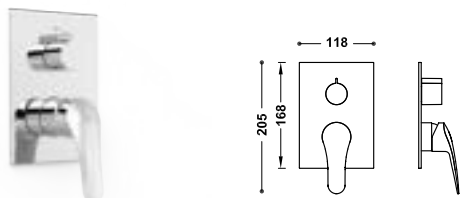

RAPID
BOX

Pieza vista para caja empotrada de 2 vías Rapid-box

21528110

Sólo parte vista. Incluye placa embellecedora, mando, volante distribuidor y tornillo de fijación oculto. Completar con la caja empotrada Rapid-box ref.: 20828110.

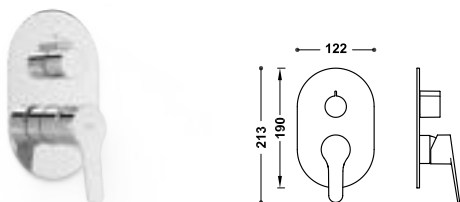

RAPID
BOX

KITS DE 2 VÍAS

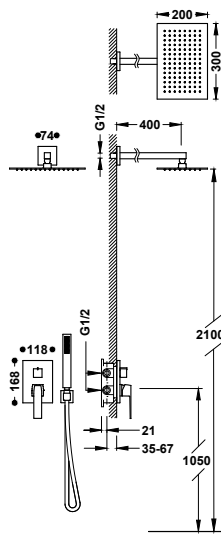

Kit de grifo monomando empotrado de 2 vías Rapid-box para ducha

- Cuerpo empotrado incluido.
- Distribuidor cerámico de 2 vías.
- Brazo a pared con rociador de ducha orientable y de acero inoxidable: 300x200 mm.
- Soporte para ducha de mano con toma de agua a pared.
- Ducha de mano anticalcárea de latón.
- Flexo satinado.

- 20228004
- 20228004NM
- 20228004BM
- 20228004AC
- 20228004OR
- 20228004OM

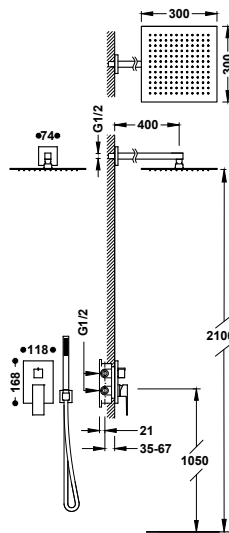

Kit de grifo monomando empotrado de 2 vías Rapid-box para ducha

- Cuerpo empotrado incluido.
- Distribuidor cerámico de 2 vías.
- Brazo a pared con rociador de ducha orientable y de acero inoxidable: 300x300 mm.
- Soporte para ducha de mano con toma de agua a pared.
- Ducha de mano anticalcárea de latón.
- Flexo satinado.

- 00628004
- 00628004NM
- 00628004BM
- 00628004AC
- 00628004OR
- 00628004OM

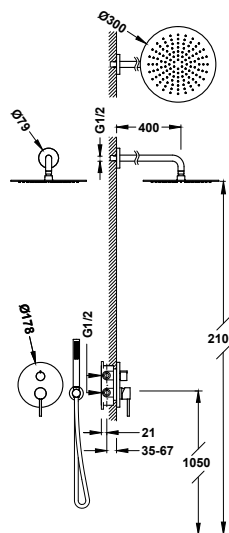

Kit de grifo monomando empotrado de 2 vías Rapid-box para ducha

- Cuerpo empotrado incluido.
- Distribuidor cerámico de 2 vías.
- Brazo a pared con rociador de ducha orientable y de acero inoxidable: Ø 300 mm.
- Soporte para ducha de mano con toma de agua a pared.
- Ducha de mano anticalcárea de latón.
- Flexo satinado.

- 26228004
- 26228004NM
- 26228004BM
- 26228004AC
- 26228004KM
- 26228004KMB
- 26228004OR
- 26228004OM
- 26228004OP
- 26228004OPM



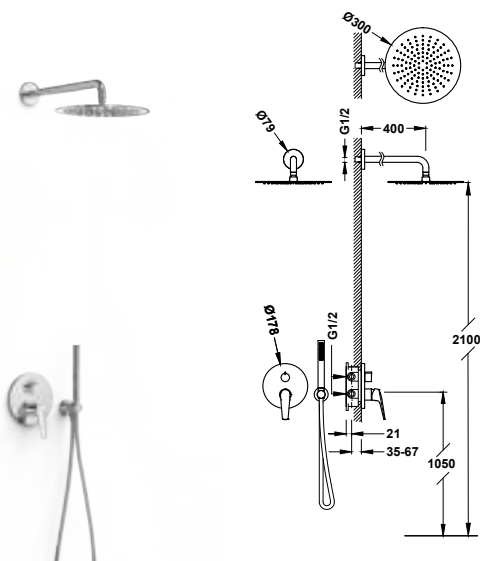

Kit de grifo monomando empotrado de 2 vías Rapid-box para ducha

- Cuerpo empotrado incluido.
- Distribuidor cerámico de 2 vías.
- Brazo a pared con rociador de ducha orientable y de acero inoxidable: Ø 300 mm.
- Soporte para ducha de mano con toma de agua a pared.
- Ducha de mano anticalcárea de latón.
- Flexo satinado.

- 28128004
- 28128004NM
- 28128004AC

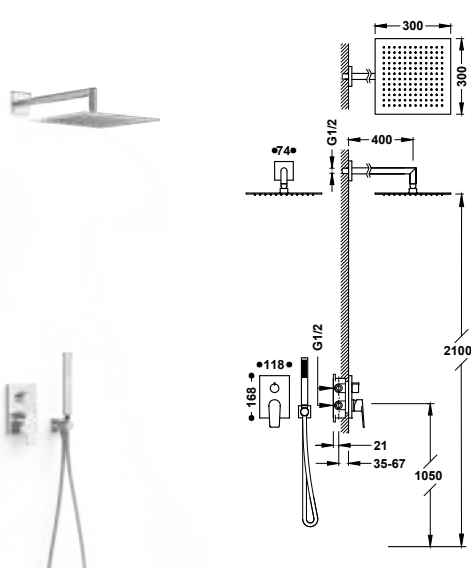

Kit de grifo monomando empotrado de 2 vías Rapid-box para ducha

- Cuerpo empotrado incluido.
- Distribuidor cerámico de 2 vías.
- Brazo a pared con rociador de ducha orientable y de acero inoxidable: 300x300 mm.
- Soporte para ducha de mano con toma de agua a pared.
- Ducha de mano anticalcárea de latón.
- Flexo satinado.

- 21128004
- 21128004NM
- 21128004BM
- 21128004AC
- 21128004KM
- 21128004KMB
- 21128004OR
- 21128004OM
- 21128004OP
- 21128004OPM

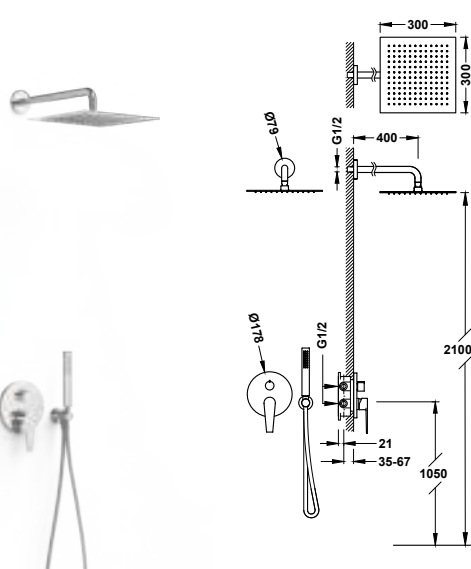

Kit de grifo monomando empotrado de 2 vías Rapid-box para ducha

- Cuerpo empotrado incluido.
- Distribuidor cerámico de 2 vías.
- Brazo a pared con rociador de ducha orientable y de acero inoxidable: 300x300 mm.
- Soporte para ducha de mano con toma de agua a pared.
- Ducha de mano anticalcárea.
- Flexo satinado.

- 20528004



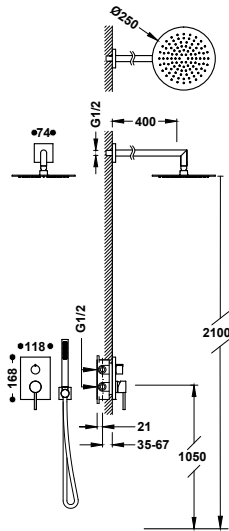

Kit de grifo monomando empotrado de 2 vías Rapid-box para ducha

06228004

- Cuerpo empotrado incluido.
- Distribuidor cerámico de 2 vías.
- Brazo a pared con rociador de ducha orientable y de acero inoxidable: Ø 250 mm.
- Soporte para ducha de mano con toma de agua a pared.
- Ducha de mano anticalcárea de latón.
- Flexo satinado.

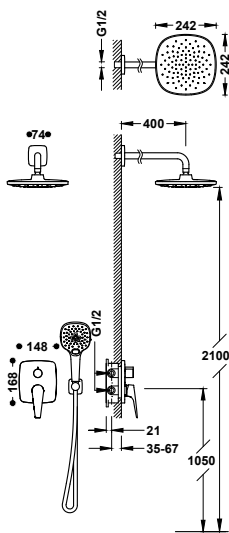

Kit de grifo monomando empotrado de 2 vías Rapid-box para ducha

21828004

- Cuerpo empotrado incluido.
- Distribuidor cerámico de 2 vías.
- Brazo a pared con rociador de ducha orientable: 242x242 mm.
- Soporte para ducha de mano con toma de agua a pared.
- Ducha de mano anticalcárea 120x120 mm. (3 tipos de chorro).
- Flexo metálico.

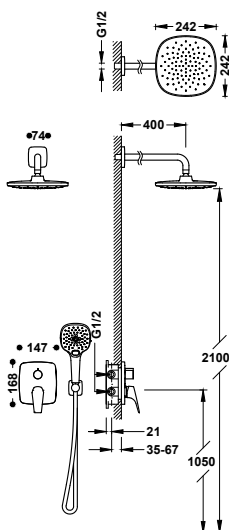

Kit de grifo monomando empotrado de 2 vías Rapid-box para ducha

21728004

- Cuerpo empotrado incluido.
- Distribuidor cerámico de 2 vías.
- Brazo a pared con rociador de ducha orientable: 242x242 mm.
- Soporte para ducha de mano con toma de agua a pared.
- Ducha de mano anticalcárea 120x120 mm. (3 tipos de chorro).
- Flexo metálico.



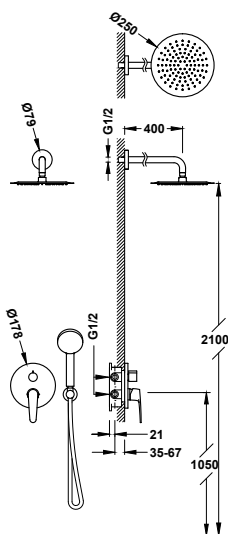

Kit de grifo monomando empotrado de 2 vías Rapid-box para ducha

20428004

- Cuerpo empotrado incluido.
- Distribuidor cerámico de 2 vías.
- Brazo a pared con rociador de ducha orientable y de acero inoxidable: Ø 250 mm.
- Soporte para ducha de mano con toma de agua a pared.
- Ducha de mano anticalcárea: Ø 110 mm.
- Flexo satinado.



29903508

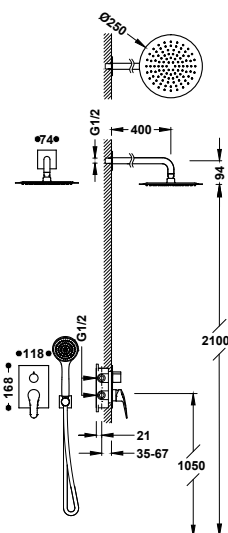

Kit de grifo monomando empotrado de 2 vías Rapid-box para ducha

21628004

- Cuerpo empotrado incluido.
- Distribuidor cerámico de 2 vías.
- Brazo a pared con rociador de ducha orientable y de acero inoxidable: Ø 250 mm.
- Soporte para ducha de mano con toma de agua a pared.
- Ducha de mano anticalcárea: Ø 100 mm.
- Flexo metálico.



29903508

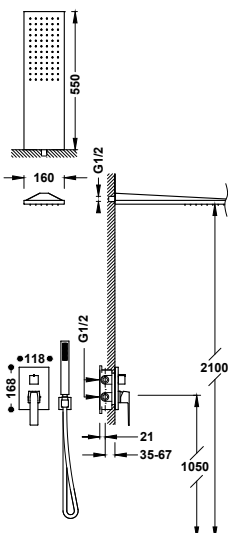

Kit de grifo monomando empotrado de 2 vías Rapid-box para ducha

20228005

- Cuerpo empotrado incluido.
- Distribuidor cerámico de 2 vías.
- Rociador de ducha a pared de acero inoxidable: 160x550 mm.
- Soporte para ducha de mano con toma de agua a pared.
- Ducha de mano anticalcárea de latón.
- Flexo satinado.

- 20228005NM
- 20228005BM
- 20228005AC
- 20228005OR
- 20228005OM



29903508

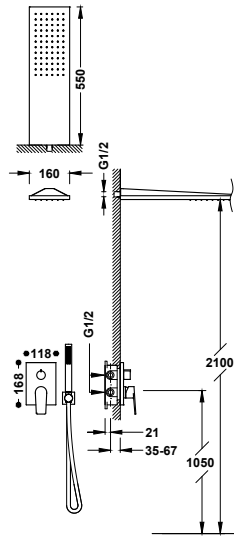

Kit de grifo monomando empotrado de 2 vías Rapid-box para ducha

- Cuerpo empotrado incluido.
- Distribuidor cerámico de 2 vías.
- Rociador de ducha a pared de acero inoxidable: 160x550 mm.
- Soporte para ducha de mano con toma de agua a pared.
- Ducha de mano anticalcárea de latón.
- Flexo satinado.

- 21128005
- 21128005NM
- 21128005BM
- 21128005AC
- 21128005KM
- 21128005KMB
- 21128005OR
- 21128005OM
- 21128005OP
- 21128005OPM



N

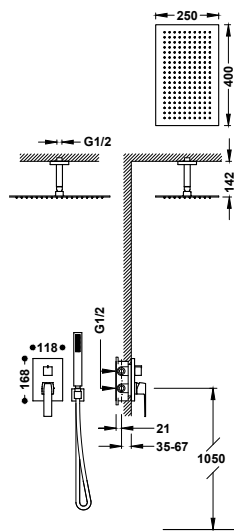

Kit de grifo monomando empotrado de 2 vías Rapid-box para ducha

- Cuerpo empotrado incluido.
- Distribuidor cerámico de 2 vías.
- Brazo a techo con rociador de ducha orientable y de acero inoxidable: 400x250 mm.
- Soporte para ducha de mano con toma de agua a pared.
- Ducha de mano anticalcárea de latón.
- Flexo satinado.

- 20228003
- 20228003NM
- 20228003BM
- 20228003AC
- 20228003OR
- 20228003OM

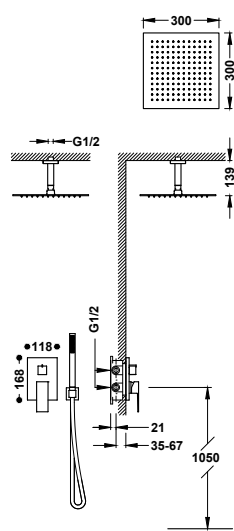

Kit de grifo monomando empotrado de 2 vías Rapid-box para ducha

- Cuerpo empotrado incluido.
- Distribuidor cerámico de 2 vías.
- Brazo a techo con rociador de ducha orientable y de acero inoxidable: 300x300 mm.
- Soporte para ducha de mano con toma de agua a pared.
- Ducha de mano anticalcárea de latón.
- Flexo satinado.

- 00628003
- 00628003NM
- 00628003BM
- 00628003AC
- 00628003OR
- 00628003OM



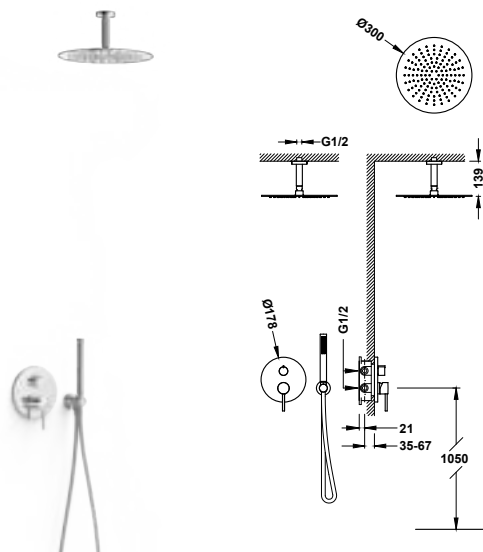

Kit de grifo monomando empotrado de 2 vías Rapid-box para ducha

- Cuerpo empotrado incluido.
- Distribuidor cerámico de 2 vías.
- Brazo a techo con rociador de ducha orientable y de acero inoxidable: Ø 300 mm.
- Soporte para ducha de mano con toma de agua a pared.
- Ducha de mano anticalcárea de latón.
- Flexo satinado.

- 26228003
- 26228003NM
- 26228003BM
- 26228003AC
- 26228003KM
- 26228003KMB
- 26228003OR
- 26228003OM
- 26228003OP
- 26228003OPM



N

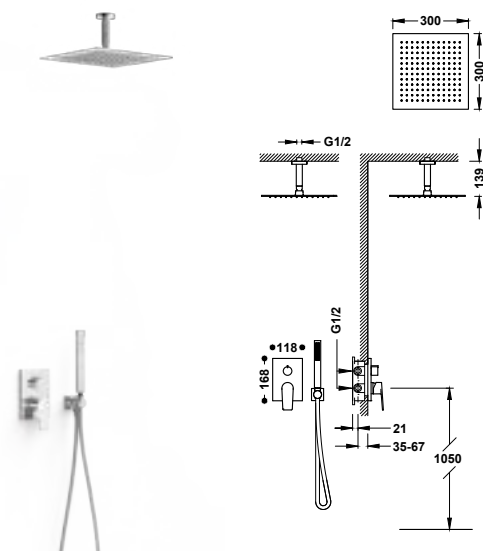

Kit de grifo monomando empotrado de 2 vías Rapid-box para ducha

- Cuerpo empotrado incluido.
- Distribuidor cerámico de 2 vías.
- Brazo a techo con rociador de ducha orientable y de acero inoxidable: 300x300 mm.
- Soporte para ducha de mano con toma de agua a pared.
- Ducha de mano anticalcárea de latón.
- Flexo satinado.

- 21128003
- 21128003NM
- 21128003BM
- 21128003AC
- 21128003KM
- 21128003KMB
- 21128003OR
- 21128003OM
- 21128003OP
- 21128003OPM

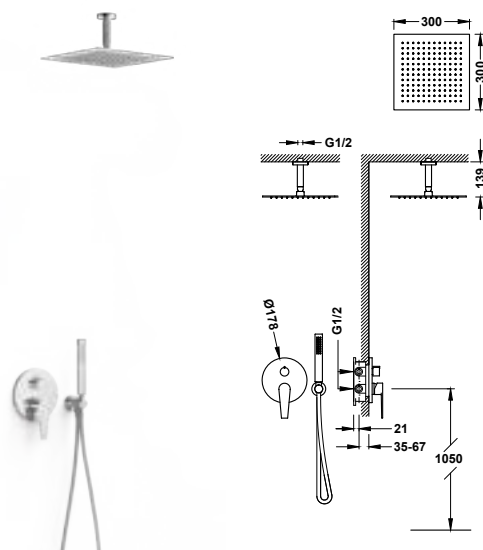

Kit de grifo monomando empotrado de 2 vías Rapid-box para ducha

- Cuerpo empotrado incluido.
- Distribuidor cerámico de 2 vías.
- Brazo a techo con rociador de ducha orientable y de acero inoxidable: 300x300 mm.
- Soporte para ducha de mano con toma de agua a pared.
- Ducha de mano anticalcárea.
- Flexo satinado.

- 20528003



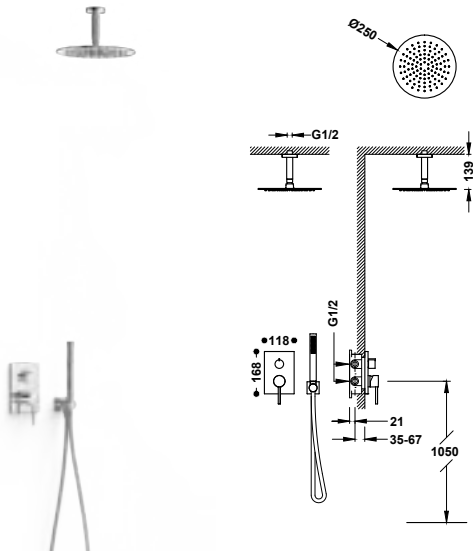

Kit de grifo monomando empotrado de 2 vías Rapid-box para ducha

06228003

- Cuerpo empotrado incluido.
- Distribuidor cerámico de 2 vías.
- Brazo a techo con rociador de ducha orientable y de acero inoxidable: Ø 250 mm.
- Soporte para ducha de mano con toma de agua a pared.
- Ducha de mano anticalcárea de latón.
- Flexo satinado.

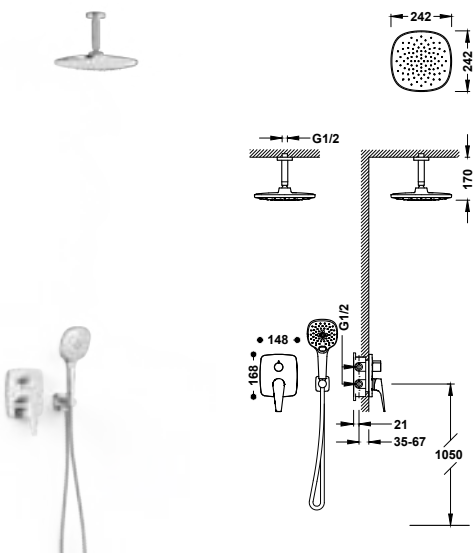

Kit de grifo monomando empotrado de 2 vías Rapid-box para ducha

21828003

- Cuerpo empotrado incluido.
- Distribuidor cerámico de 2 vías.
- Brazo a techo con rociador de ducha orientable: 242x242 mm.
- Soporte para ducha de mano con toma de agua a pared.
- Ducha de mano anticalcárea 120x120 mm. (3 tipos de chorro).
- Flexo metálico.

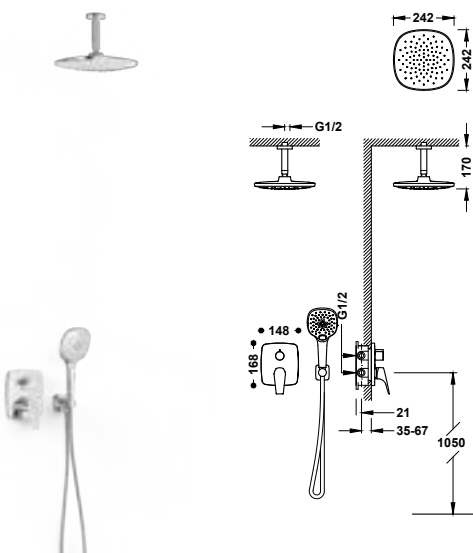

Kit de grifo monomando empotrado de 2 vías Rapid-box para ducha

21728003

- Cuerpo empotrado incluido.
- Distribuidor cerámico de 2 vías.
- Brazo a techo con rociador de ducha orientable: 242x242 mm.
- Soporte para ducha de mano con toma de agua a pared.
- Ducha de mano anticalcárea 120x120 mm. (3 tipos de chorro).
- Flexo metálico.



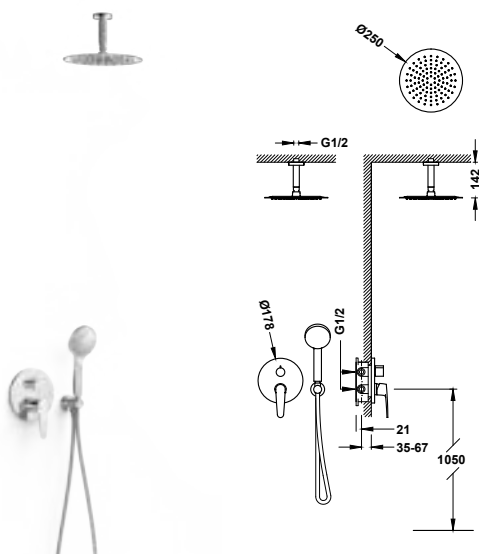

Kit de grifo monomando empotrado de 2 vías Rapid-box para ducha

20428003

- Cuerpo empotrado incluido.
- Distribuidor cerámico de 2 vías.
- Brazo a techo con rociador de ducha orientable y de acero inoxidable: Ø 250 mm.
- Soporte para ducha de mano con toma de agua a pared.
- Ducha de mano anticalcárea: Ø 110 mm.
- Flexo satinado.

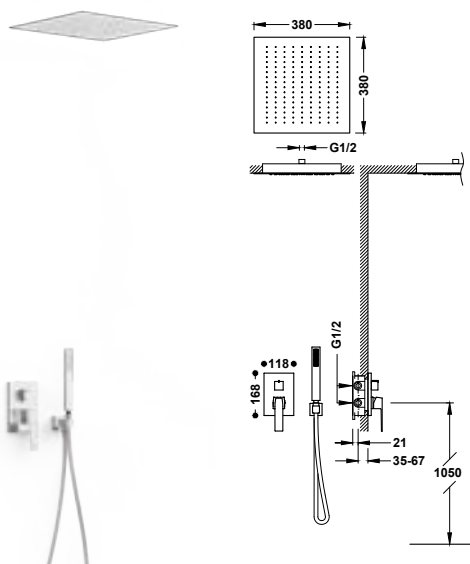

Kit de grifo monomando empotrado de 2 vías Rapid-box para ducha

20228006

- Cuerpo empotrado incluido.
- Distribuidor cerámico de 2 vías.
- Rociador de ducha empotrado a techo de acero inoxidable: 380x380 mm.
- Soporte para ducha de mano con toma de agua a pared.
- Ducha de mano anticalcárea de latón.
- Flexo satinado.

- 20228006NM
- 20228006BM
- 20228006AC
- 20228006OR
- 20228006OM

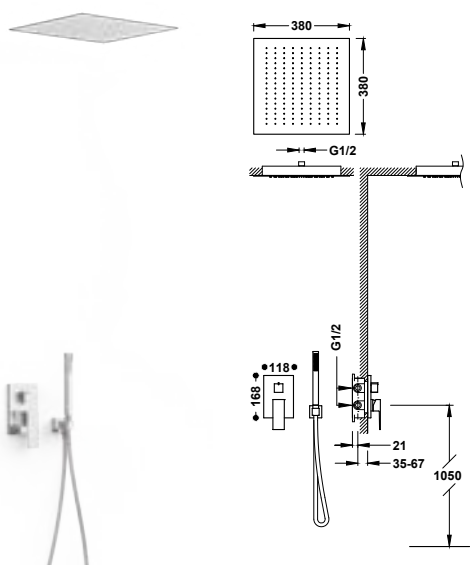

Kit de grifo monomando empotrado de 2 vías Rapid-box para ducha

00628005

- Cuerpo empotrado incluido.
- Distribuidor cerámico de 2 vías.
- Rociador de ducha empotrado a techo de acero inoxidable: 380x380 mm.
- Soporte para ducha de mano con toma de agua a pared.
- Ducha de mano anticalcárea de latón.
- Flexo satinado.

- 00628005NM
- 00628005BM
- 00628005AC
- 00628005OR
- 00628005OM



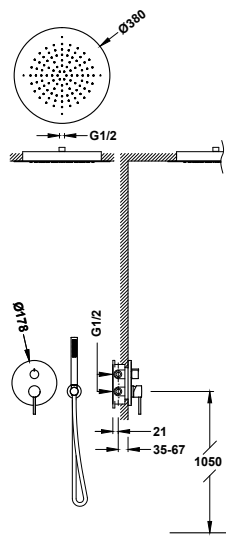

Kit de grifo monomando empotrado de 2 vías Rapid-box para ducha

- Cuerpo empotrado incluido.
- Distribuidor cerámico de 2 vías.
- Rociador de ducha empotrado a techo de acero inoxidable: Ø 380 mm.
- Soporte para ducha de mano con toma de agua a pared.
- Ducha de mano anticalcárea de latón.
- Flexo satinado.

- 26228005
- 26228005NM
- 26228005BM
- 26228005AC
- 26228005KM
- 26228005KMB
- 26228005OR
- 26228005OM
- 26228005OP
- 26228005OPM

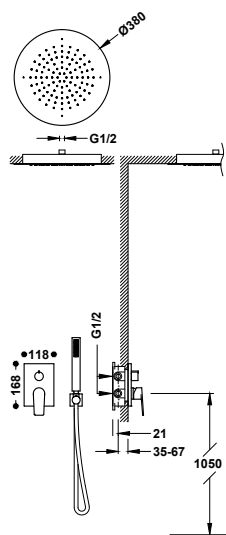

Kit de grifo monomando empotrado de 2 vías Rapid-box para ducha

- Cuerpo empotrado incluido.
- Distribuidor cerámico de 2 vías.
- Rociador de ducha empotrado a techo de acero inoxidable: Ø 380 mm.
- Soporte para ducha de mano con toma de agua a pared.
- Ducha de mano anticalcárea de latón.
- Flexo satinado.

- 21128006
- 21128006NM
- 21128006BM
- 21128006AC
- 21128006KM
- 21128006KMB
- 21128006OR
- 21128006OM
- 21128006OP
- 21128006OPM

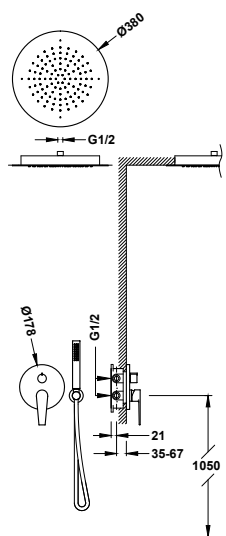

Kit de grifo monomando empotrado de 2 vías Rapid-box para ducha

- Cuerpo empotrado incluido.
- Distribuidor cerámico de 2 vías.
- Rociador de ducha empotrado a techo de acero inoxidable: Ø 380 mm.
- Soporte para ducha de mano con toma de agua a pared.
- Ducha de mano anticalcárea.
- Flexo satinado.

- 20528005



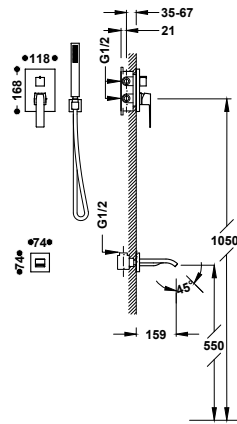

Kit de grifo monomando empotrado de 2 vías Rapid-box para bañera y ducha

- Cuerpo empotrado incluido.
- Distribuidor cerámico de 2 vías.
- Caño fijo de bañera a pared.
- Soporte para ducha de mano con toma de agua a pared.
- Ducha de mano anticalcárea de latón.
- Flexo satinado.

- 20228007
- 20228007NM
- 20228007BM
- 20228007AC
- 20228007OR
- 20228007OM

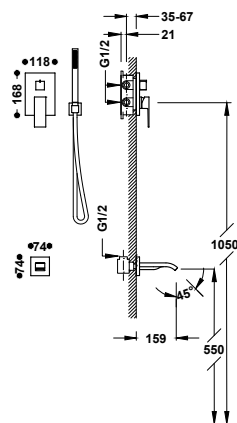

Kit de grifo monomando empotrado de 2 vías Rapid-box para bañera y ducha

- Cuerpo empotrado incluido.
- Distribuidor cerámico de 2 vías.
- Caño fijo de bañera a pared.
- Soporte para ducha de mano con toma de agua a pared.
- Ducha de mano anticalcárea de latón.
- Flexo satinado.

- 00628006
- 00628006NM
- 00628006BM
- 00628006AC
- 00628006OR
- 00628006OM

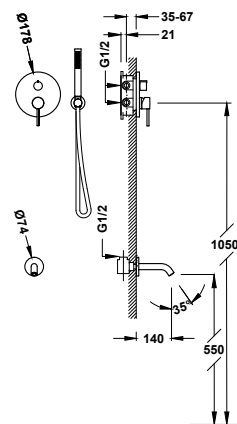
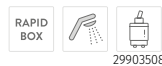

Kit de grifo monomando empotrado de 2 vías Rapid-box para bañera y ducha

- Cuerpo empotrado incluido.
- Distribuidor cerámico de 2 vías.
- Caño fijo de bañera a pared.
- Soporte para ducha de mano con toma de agua a pared.
- Ducha de mano anticalcárea de latón.
- Flexo satinado.

- 26228006
- 26228006NM
- 26228006BM
- 26228006AC
- 26228006KM
- 26228006KMB
- 26228006OR
- 26228006OM
- 26228006OP
- 26228006OPM



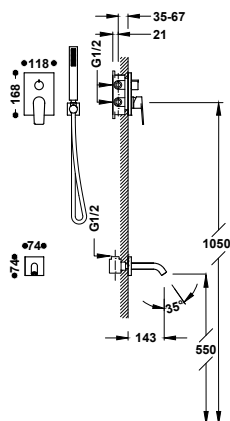

Kit de grifo monomando empotrado de 2 vías Rapid-box para bañera y ducha

- Cuerpo empotrado incluido.
- Distribuidor cerámico de 2 vías.
- Caño fijo de bañera a pared.
- Soporte para ducha de mano con toma de agua a pared.
- Ducha de mano anticalcárea de latón.
- Flexo satinado.

- 21128007
- 21128007NM
- 21128007BM
- 21128007AC
- 21128007KM
- 21128007KMB
- 21128007OR
- 21128007OM
- 21128007OP
- 21128007OPM



N

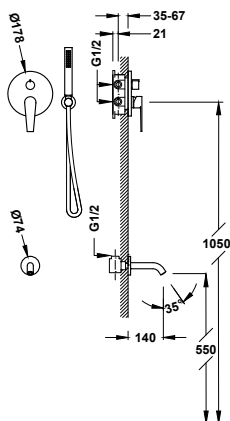

Kit de grifo monomando empotrado de 2 vías Rapid-box para bañera y ducha

- Cuerpo empotrado incluido.
- Distribuidor cerámico de 2 vías.
- Caño fijo de bañera a pared.
- Soporte para ducha de mano con toma de agua a pared.
- Ducha de mano anticalcárea.
- Flexo satinado.

- 20528006

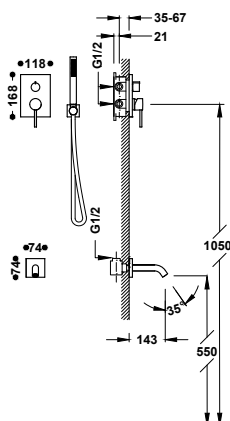

Kit de grifo monomando empotrado de 2 vías Rapid-box para bañera y ducha

- Cuerpo empotrado incluido.
- Distribuidor cerámico de 2 vías.
- Caño fijo de bañera a pared.
- Soporte para ducha de mano con toma de agua a pared.
- Ducha de mano anticalcárea de latón.
- Flexo satinado.

- 06228006





Kit de grifo monomando empotrado de 2 vías Rapid-box para bañera y ducha

21828006

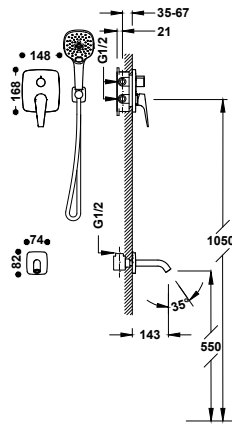

- Cuerpo empotrado incluido.
- Distribuidor cerámico de 2 vías.
- Caño fijo de bañera a pared.
- Soporte para ducha de mano con toma de agua a pared.
- Ducha de mano anticalcárea 120x120 mm. (3 tipos de chorro).
- Flexo metálico.



29903508



Kit de grifo monomando empotrado de 2 vías Rapid-box para bañera y ducha

20428006

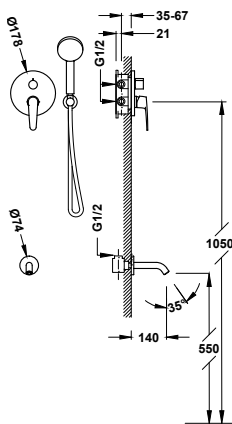

- Cuerpo empotrado incluido.
- Distribuidor cerámico de 2 vías.
- Caño fijo de bañera a pared.
- Soporte para ducha de mano con toma de agua a pared.
- Ducha de mano anticalcárea: Ø 110 mm.
- Flexo satinado.



29903508

MONOMANDOS EMPOTRADOS

Los monomandos empotrados son una opción muy funcional para equipar la ducha con elementos de diseño minimalista. El manejo cómodo con un solo mando y la facilidad de uso son sus características más destacadas. El cuerpo empotrado y la parte vista de cada artículo se suministra unida, lista para instalar.

Acabados disponibles:





GRIFOS EMPOTRADOS

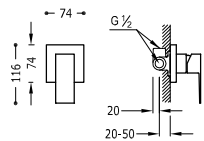

Grifo monomando empotrado de 1 vía para ducha
Cuerpo empotrado incluido.

106177



Alargadera para grifo monomando empotrado de 1 vía para ducha

10617710

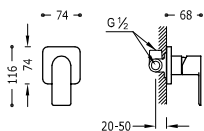

Grifo monomando empotrado de 1 vía para ducha
Cuerpo empotrado incluido.

20017701

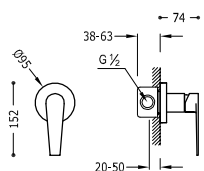

Grifo monomando empotrado de 1 vía para ducha
Cuerpo empotrado incluido.

20517701

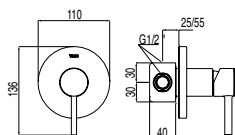

Grifo monomando empotrado de 1 vía para ducha
Cuerpo empotrado incluido.

20317701



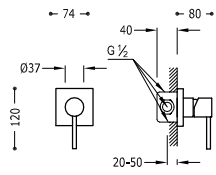
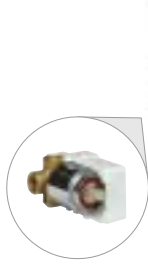

Grifo monomando empotrado de 1 vía para ducha
Cuerpo empotrado incluido.

06217702

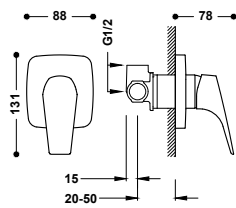
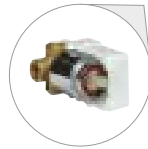

Grifo monomando empotrado de 1 vía para ducha
Cuerpo empotrado incluido.

21717701

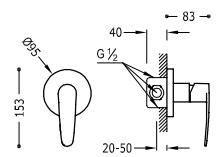

Grifo monomando empotrado de 1 vía para ducha
Cuerpo empotrado incluido.

20417701

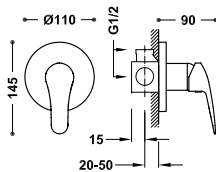

Grifo monomando empotrado de 1 vía para ducha
Cuerpo empotrado incluido.

21617701

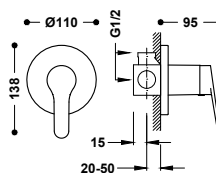

Grifo monomando empotrado de 1 vía para ducha
Cuerpo empotrado incluido.

21517701



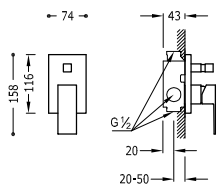

Grifo monomando empotrado de 2 vías para bañera y ducha 106180
Cuerpo empotrado incluido. Inversor de 2 vías.



Set de prolongación para los grifos monomando empotrado de 2 vías 10618010

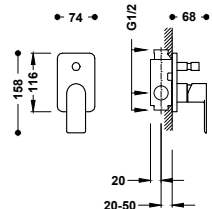
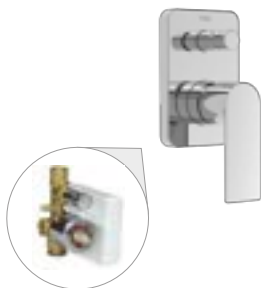

Grifo monomando empotrado de 2 vías para bañera y ducha 20018001
Cuerpo empotrado incluido. Inversor de 2 vías.



- 20018001NM
- 20018001BM
- 20018001AC
- 20018001OR
- 20018001OM



Set de prolongación para los grifos monomando empotrado de 2 vías 20018010

- 20018010OR
- 20018010OM

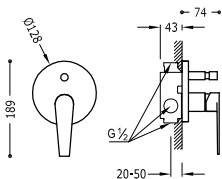

Grifo monomando empotrado de 2 vías para bañera y ducha 20518001
Cuerpo empotrado incluido. Inversor de 2 vías.

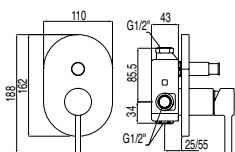

Grifo monomando empotrado de 2 vías para bañera y ducha 20318001
Cuerpo empotrado incluido. Inversor de 2 vías.



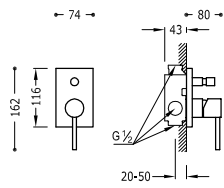

Grifo monomando empotrado de 2 vías para bañera y ducha
Cuerpo empotrado incluido. Inversor de 2 vías.

06218002

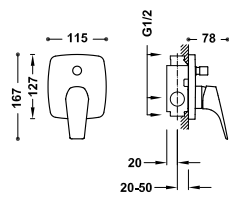

Grifo monomando empotrado de 2 vías para bañera y ducha
Cuerpo empotrado incluido. Inversor de 2 vías.

21718001

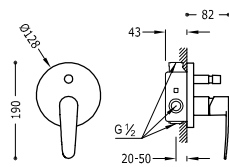

Grifo monomando empotrado de 2 vías para bañera y ducha
Cuerpo empotrado incluido. Inversor de 2 vías.

20418001

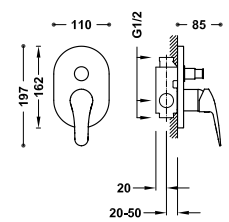

Grifo monomando empotrado de 2 vías para bañera y ducha
Cuerpo empotrado incluido. Inversor de 2 vías.

21618001

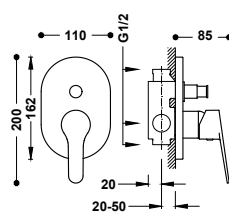

Grifo monomando empotrado de 2 vías para bañera y ducha
Cuerpo empotrado incluido. Inversor de 2 vías.

21518001



KITS DE 2 VÍAS

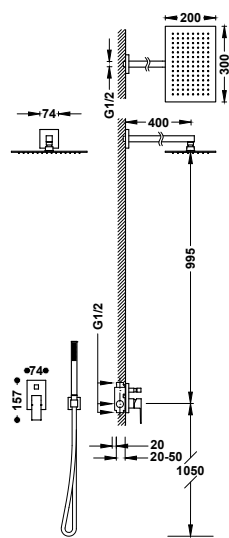

Kit de grifo monomando empotrado de 2 vías para ducha

00698003

- Cuerpo empotrado incluido.
- Inversor de 2 vías.
- Brazo a pared con rociador de ducha orientable y de acero inoxidable: 300x200 mm.
- Soporte para ducha de mano con toma de agua a pared.
- Ducha de mano anticalcárea de latón.
- Flexo satinado.

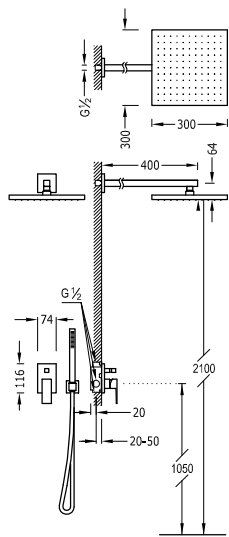

Kit de grifo monomando empotrado de 2 vías para ducha

106980

- Cuerpo empotrado incluido.
- Inversor de 2 vías.
- Brazo a pared con rociador de ducha orientable y de acero inoxidable: 300x300 mm.
- Soporte para ducha de mano con toma de agua a pared.
- Ducha de mano anticalcárea de latón.
- Flexo satinado.

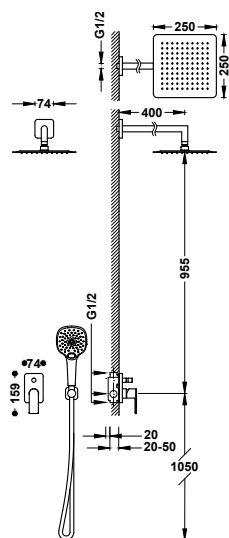

Kit de grifo monomando empotrado de 2 vías para ducha

20018011

- Cuerpo empotrado incluido.
- Inversor de 2 vías.
- Brazo a pared con rociador de ducha orientable y de acero inoxidable: 250x250mm.
- Soporte para ducha de mano con toma de agua a pared.
- Ducha de mano anticalcárea: 120x120 mm. (3 tipos de chorro).
- Flexo satinado.



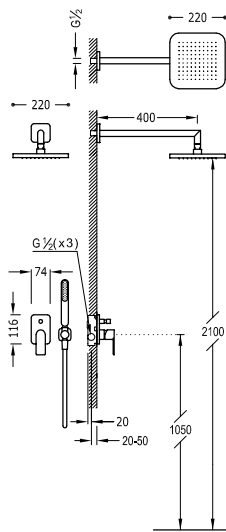

Kit de grifo monomando empotrado de 2 vías para ducha

20018002

- Cuerpo empotrado incluido.
- Inversor de 2 vías.
- Brazo a pared con rociador de ducha orientable: 220x220 mm.
- Soporte para ducha de mano con toma de agua a pared.
- Ducha de mano anticalcárea.
- Flexo satinado.



9130190

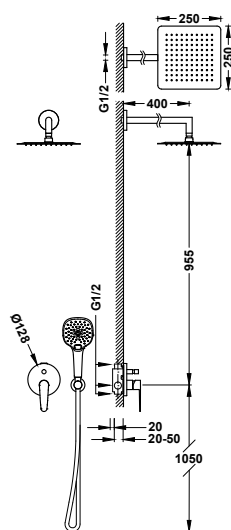

Kit de grifo monomando empotrado de 2 vías para ducha

20518006

- Cuerpo empotrado incluido.
- Inversor de 2 vías.
- Brazo a pared con rociador de ducha orientable y de acero inoxidable: 250x250 mm.
- Soporte para ducha de mano con toma de agua a pared.
- Ducha de mano anticalcárea: 120x120 mm. (3 tipos de chorro).
- Flexo satinado.



9130190

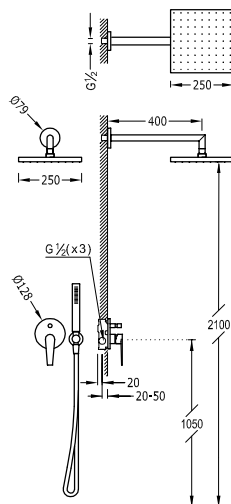

Kit de grifo monomando empotrado de 2 vías para ducha

20518002

- Cuerpo empotrado incluido.
- Inversor de 2 vías.
- Brazo a pared con rociador de ducha orientable y de acero inoxidable: 250x250 mm.
- Soporte para ducha de mano con toma de agua a pared.
- Ducha de mano anticalcárea.
- Flexo satinado.



9130190

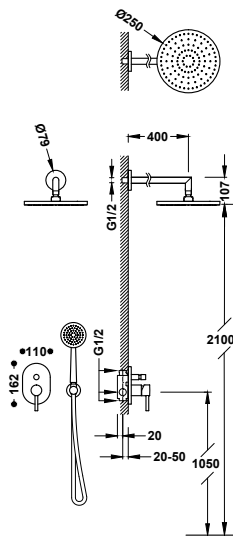

Kit de grifo monomando empotrado de 2 vías para ducha

20318002

- Cuerpo empotrado incluido.
- Inversor de 2 vías.
- Brazo a pared con rociador de ducha orientable y de acero inoxidable: Ø 250 mm.
- Soporte para ducha de mano con toma de agua a pared.
- Ducha de mano anticalcárea: Ø 100 mm.
- Flexo satinado.

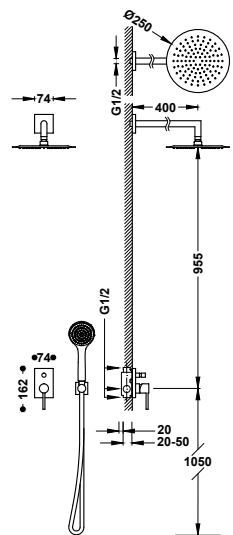

Kit de grifo monomando empotrado de 2 vías para ducha

06298004

- Cuerpo empotrado incluido.
- Inversor de 2 vías.
- Brazo a pared con rociador de ducha orientable y de acero inoxidable: Ø 250 mm.
- Soporte para ducha de mano con toma de agua a pared.
- Ducha de mano anticalcárea.
- Flexo satinado.

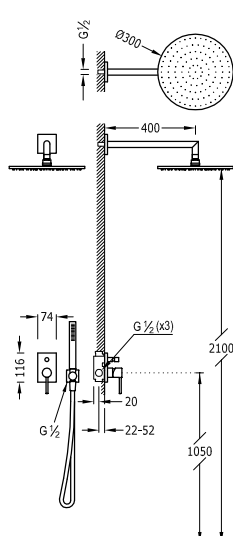

Kit de grifo monomando empotrado de 2 vías para ducha

06298001

- Cuerpo empotrado incluido.
- Inversor de 2 vías.
- Brazo a pared con rociador de ducha orientable y de acero inoxidable: Ø 300 mm.
- Soporte para ducha de mano con toma de agua a pared.
- Ducha de mano anticalcárea de latón.
- Flexo satinado.



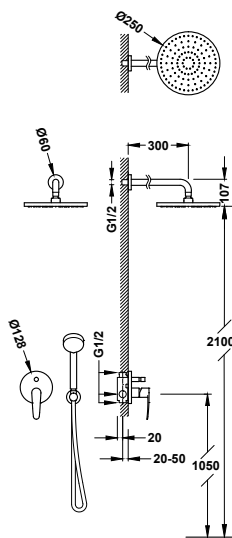

Kit de grifo monomando empotrado de 2 vías para ducha

■ 20418002

- Cuerpo empotrado incluido.
- Inversor de 2 vías.
- Brazo a pared con rociador de ducha orientable y de acero inoxidable: Ø 250 mm.
- Soporte para ducha de mano con toma de agua a pared.
- Ducha de mano anticalcárea: Ø 100 mm.
- Flexo satinado.

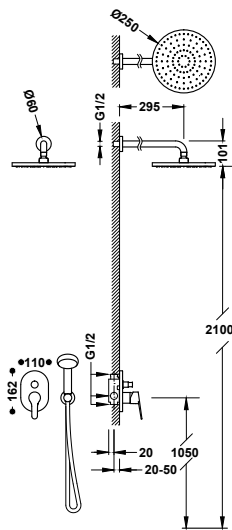

Kit de grifo monomando empotrado de 2 vías para ducha

■ 21599002

- Cuerpo empotrado incluido.
- Inversor de 2 vías.
- Brazo a pared con rociador de ducha orientable: Ø 250 mm.
- Soporte para ducha de mano con toma de agua a pared.
- Ducha de mano anticalcárea.
- Flexo metálico.

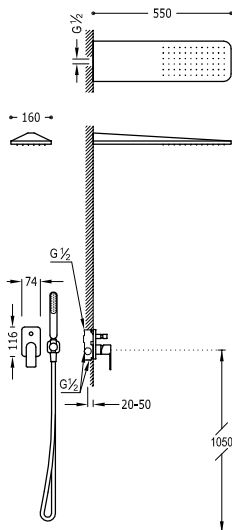

Kit de grifo monomando empotrado de 2 vías para ducha

■ 20018005

- Cuerpo empotrado incluido.
- Inversor de 2 vías.
- Rociador de ducha a pared de acero inoxidable: 160x550 mm.
- Soporte para ducha de mano con toma de agua a pared.
- Ducha de mano anticalcárea.
- Flexo satinado.

- 20018005NM
- 20018005BM
- 20018005AC
- 20018005OR
- 20018005OM



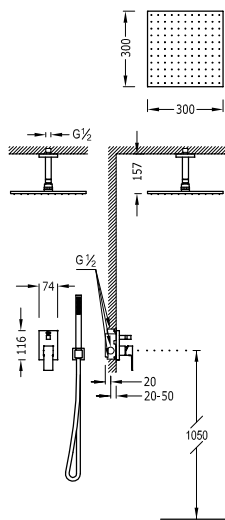

Kit de grifo monomando empotrado de 2 vías para ducha

00618080

- Cuerpo empotrado incluido.
- Inversor de 2 vías.
- Brazo a techo con rociador de ducha orientable y de acero inoxidable: 300x300 mm.
- Soporte para ducha de mano con toma de agua a pared.
- Ducha de mano anticalcárea de latón.
- Flexo satinado.

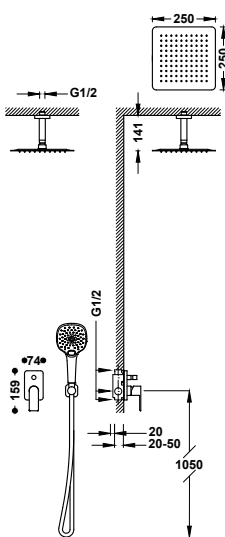

Kit de grifo monomando empotrado de 2 vías para ducha

20018009

- Cuerpo empotrado incluido.
- Inversor de 2 vías.
- Brazo a techo con rociador de ducha orientable y de acero inoxidable: 250x250mm.
- Soporte para ducha de mano con toma de agua a pared.
- Ducha de mano anticalcárea: 120x120 mm. (3 tipos de chorro).
- Flexo satinado.

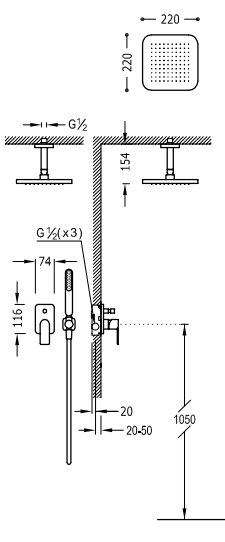

Kit de grifo monomando empotrado de 2 vías para ducha

20018080

- Cuerpo empotrado incluido.
- Inversor de 2 vías.
- Brazo a techo con rociador de ducha orientable: 220x220 mm.
- Soporte para ducha de mano con toma de agua a pared.
- Ducha de mano anticalcárea.
- Flexo satinado.



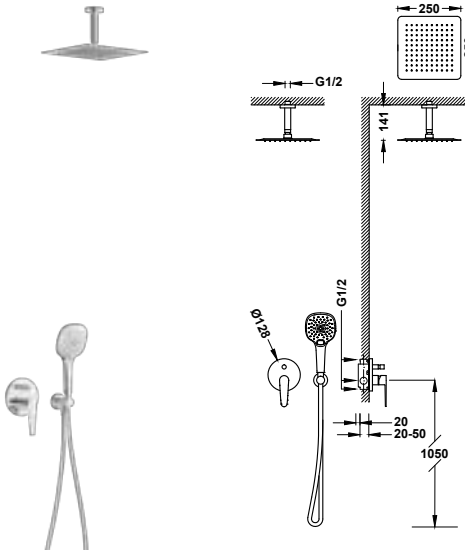

Kit de grifo monomando empotrado de 2 vías para ducha

20518007

- Cuerpo empotrado incluido.
- Inversor de 2 vías.
- Brazo a techo con rociador de ducha orientable y de acero inoxidable: 250x250 mm.
- Soporte para ducha de mano con toma de agua a pared.
- Ducha de mano anticalcárea: 120x120 mm. (3 tipos de chorro).
- Flexo satinado.

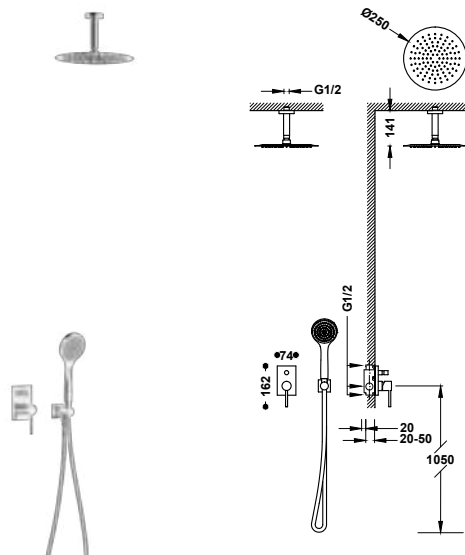

Kit de grifo monomando empotrado de 2 vías para ducha

06218081

- Cuerpo empotrado incluido.
- Inversor de 2 vías.
- Brazo a techo con rociador de ducha orientable y de acero inoxidable: Ø 250 mm.
- Soporte para ducha de mano con toma de agua a pared.
- Ducha de mano anticalcárea.
- Flexo satinado.

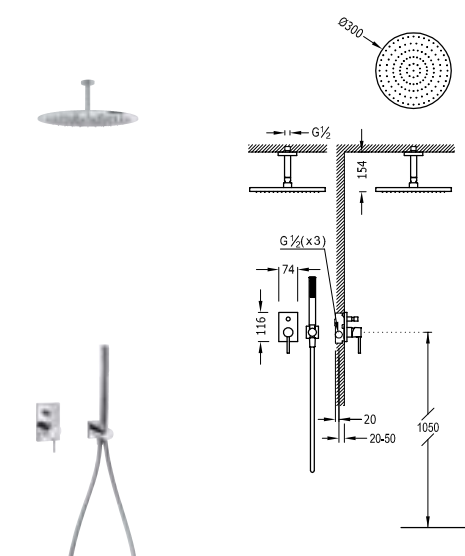
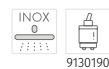

Kit de grifo monomando empotrado de 2 vías para ducha

06218080

- Cuerpo empotrado incluido.
- Inversor de 2 vías.
- Brazo a techo con rociador de ducha orientable y de acero inoxidable: Ø 300 mm.
- Soporte para ducha de mano con toma de agua a pared.
- Ducha de mano anticalcárea de latón.
- Flexo satinado.



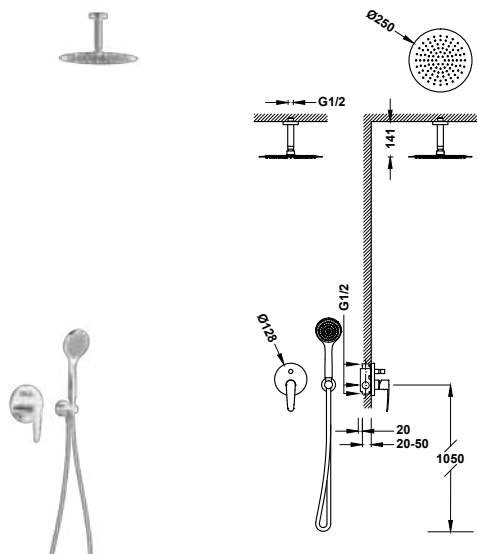

Kit de grifo monomando empotrado de 2 vías para ducha

20418005

- Cuerpo empotrado incluido.
- Inversor de 2 vías.
- Brazo a techo con rociador de ducha orientable y de acero inoxidable: Ø 250 mm.
- Soporte para ducha de mano con toma de agua a pared.
- Ducha de mano anticalcárea: Ø 100 mm.
- Flexo satinado.

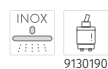



MONOMANDOS MURALES

Los monomandos para la ducha son una solución sencilla y de fácil instalación con diferentes diseños y formas que se adaptan a cualquier espacio. Destacan por su funcionalidad, un manejo cómodo desde un solo mando y alta resistencia al paso del tiempo.

Acabados disponibles:



CR



NM



BM



AC





CONJUNTOS MONOMADO PARA DUCHA

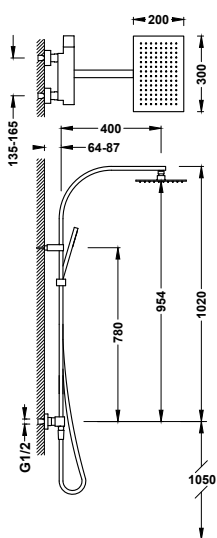

Conjunto de grifo monomando mural de 2 vías para ducha

- Rociador de ducha orientable de acero inoxidable: 300x200 mm.
- Soporte deslizante y orientable para ducha de mano.
- Ducha de mano anticalcárea de latón.
- Flexo satinado.

- 20219101
- 20219101NM
- 20219101BM
- 20219101AC

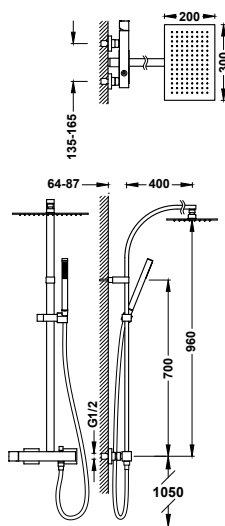

Conjunto de grifo monomando mural de 2 vías para ducha

- Rociador de ducha orientable de acero inoxidable: 300x200 mm.
- Soporte deslizante y orientable para ducha de mano.
- Ducha de mano anticalcárea de latón.
- Flexo satinado.

- 00719102

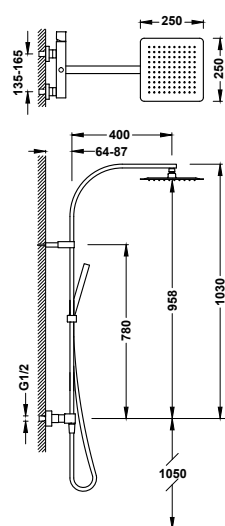

Conjunto de grifo monomando mural de 2 vías para ducha

- Rociador de ducha orientable de acero inoxidable: 250x250 mm.
- Soporte deslizante y orientable para ducha de mano.
- Ducha de mano anticalcárea de latón.
- Flexo satinado.

- 00719101



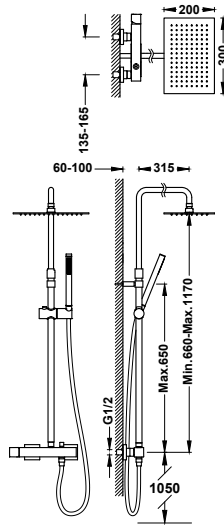

Conjunto de grifo monomando mural de 2 vías para ducha

00719702

- Rociador de ducha orientable de acero inoxidable: 300x200 mm.
- Barra de ducha telescópica.
- Soporte deslizante y orientable para ducha de mano.
- Ducha de mano anticalcárea de latón.
- Flexo satinado.

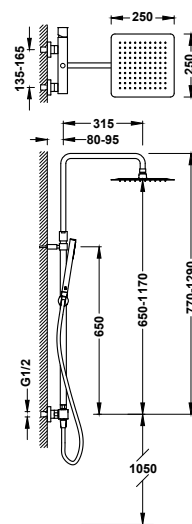

Conjunto de grifo monomando mural de 2 vías para ducha

00719701

- Rociador de ducha orientable de acero inoxidable: 250x250 mm.
- Barra de ducha telescópica.
- Soporte deslizante y orientable para ducha de mano.
- Ducha de mano anticalcárea de latón.
- Flexo satinado.

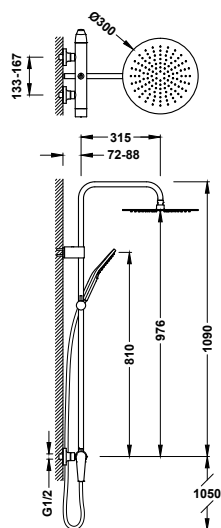

Conjunto de grifo monomando mural de 2 vías para ducha

28119101

- Rociador de ducha orientable de acero inoxidable: Ø 300 mm.
- Soporte deslizante y orientable para ducha de mano.
- Ducha de mano anticalcárea: Ø 110 mm. (3 tipos de chorro).
- Flexo satinado.

28119101NM

28119101AC



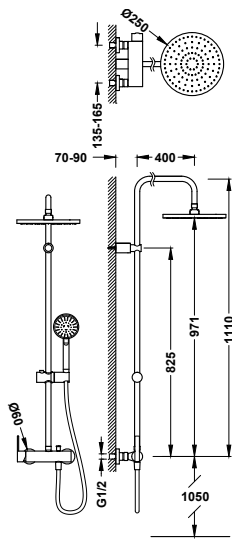

Conjunto de grifo monomando mural de 2 vías para ducha

■ 181191

- Rociador de ducha orientable de acero inoxidable: Ø 250 mm.
- Soporte deslizante y orientable para ducha de mano.
- Ducha de mano anticalcárea: Ø 100 mm. (5 tipos de chorro).
- Flexo satinado.

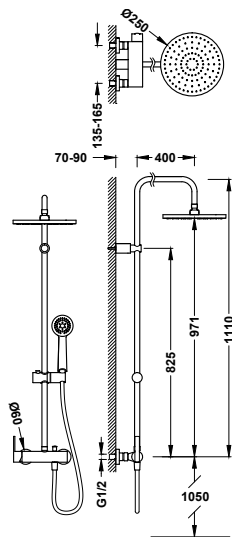

Conjunto de grifo monomando mural de 2 vías para ducha

■ 081192

- Rociador de ducha orientable de acero inoxidable: Ø 250 mm.
- Soporte deslizante y orientable para ducha de mano.
- Ducha de mano anticalcárea: Ø 100 mm.
- Flexo metálico reforzado.

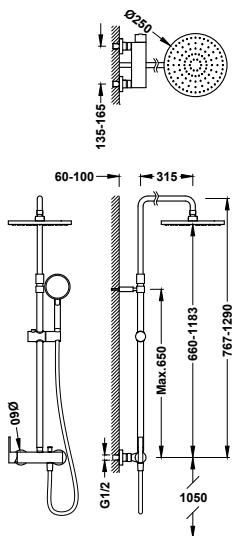

Conjunto de grifo monomando mural de 2 vías para ducha

■ 08119702

- Rociador de ducha orientable de acero inoxidable: Ø 250 mm.
- Barra de ducha telescópica.
- Soporte deslizante y orientable para ducha de mano.
- Ducha de mano anticalcárea: Ø 100 mm. (5 tipos de chorro).
- Flexo satinado.



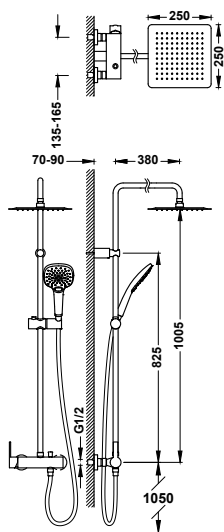

Conjunto de grifo monomando mural de 2 vías para ducha

08119302

- Rociador de ducha orientable de acero inoxidable: 250x250 mm.
- Soporte deslizante y orientable para ducha de mano.
- Ducha de mano anticalcárea: 120x120 mm. (3 tipos de chorro).
- Flexo satinado.

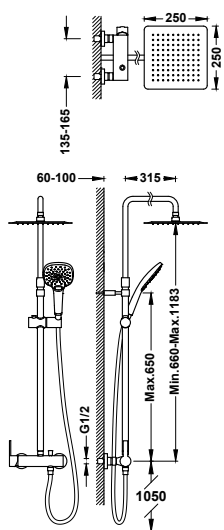

Conjunto de grifo monomando mural de 2 vías para ducha

08119704

- Rociador de ducha orientable de acero inoxidable: 250x250 mm.
- Barra de ducha telescópica.
- Soporte deslizante y orientable para ducha de mano.
- Ducha de mano anticalcárea: 120x120 mm. (3 tipos de chorro).
- Flexo satinado.

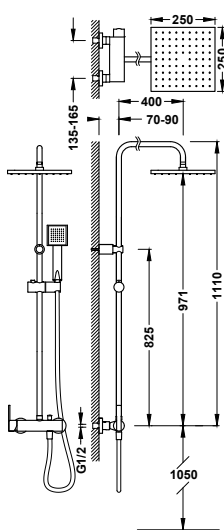

Conjunto de grifo monomando mural de 2 vías para ducha

08119301

- Rociador de ducha orientable de acero inoxidable: 250x250 mm.
- Soporte deslizante y orientable para ducha de mano.
- Ducha de mano anticalcárea: 80x80 mm.
- Flexo satinado.

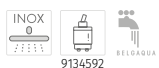

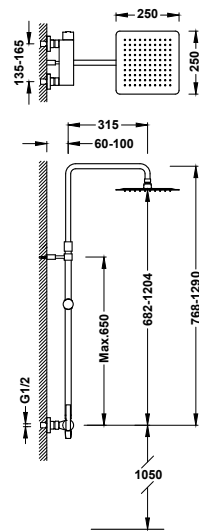

Conjunto de grifo monomando mural de 2 vías para ducha

08119701

- Rociador de ducha orientable de acero inoxidable: 250x250 mm.
- Barra de ducha telescópica.
- Soporte deslizante y orientable para ducha de mano.
- Ducha de mano anticalcárea.
- Flexo satinado.

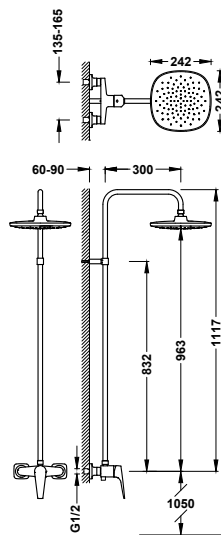

Conjunto de grifo monomando mural de 1 vía para ducha

21899501

- Rociador de ducha orientable: 242x242 mm.

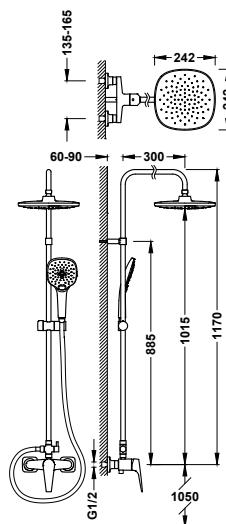

Conjunto de grifo monomando mural de 2 vías para ducha

21819101

- Con inversor integrado en la barra de ducha.
- Rociador de ducha orientable: 242x242 mm.
- Soporte deslizante y orientable para ducha de mano.
- Ducha de mano anticalcárea 120x120 mm. (3 tipos de chorro).
- Flexo metálico.



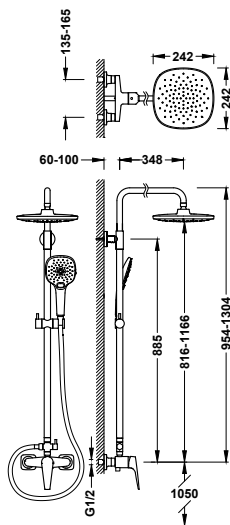

Conjunto de grifo monomando mural de 2 vías para ducha

21831221

- Con inversor integrado en la barra de ducha.
- Barra de ducha telescópica.
- Rociador de ducha orientable: 242x242 mm.
- Soporte deslizante y orientable para ducha de mano.
- Ducha de mano anticalcárea 120x120 mm. (3 tipos de chorro).
- Flexo metálico.

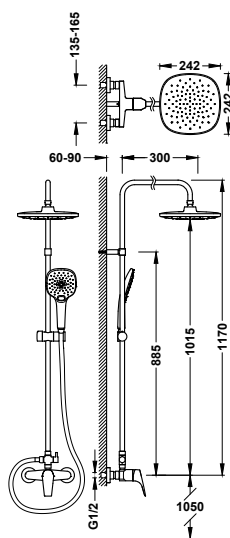
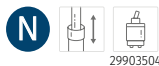

Conjunto de grifo monomando mural de 2 vías para ducha

21719101

- Con inversor integrado en la barra de ducha.
- Rociador de ducha orientable: 242x242 mm.
- Soporte deslizante y orientable para ducha de mano.
- Ducha de mano anticalcárea 120x120 mm. (3 tipos de chorro).
- Flexo metálico.

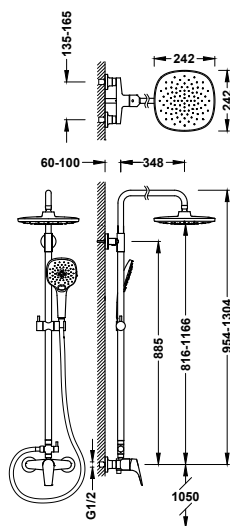

Conjunto de grifo monomando mural de 2 vías para ducha

21731221

- Con inversor integrado en la barra de ducha.
- Barra de ducha telescópica.
- Rociador de ducha orientable: 242x242 mm.
- Soporte deslizante y orientable para ducha de mano.
- Ducha de mano anticalcárea 120x120 mm. (3 tipos de chorro).
- Flexo metálico.



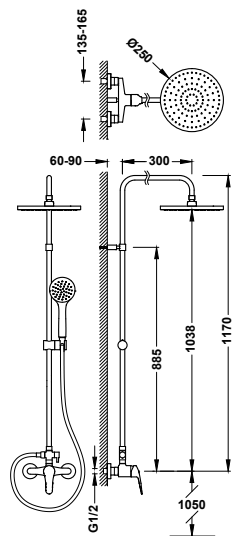

Conjunto de grifo monomando mural de 2 vías para ducha

21619110

- Con inversor integrado en la barra de ducha.
- Rociador de ducha orientable: Ø 250 mm.
- Soporte deslizable y orientable para ducha de mano.
- Ducha de mano anticalcárea.
- Flexo metálico.



29903504

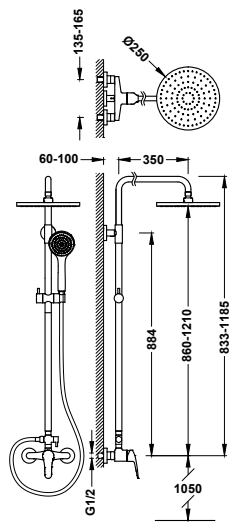

Conjunto de grifo monomando mural de 2 vías para ducha

21631221

- Con inversor integrado en la barra de ducha.
- Rociador de ducha orientable: Ø 250 mm.
- Barra de ducha telescópica.
- Soporte deslizable y orientable para ducha de mano.
- Ducha de mano anticalcárea.
- Flexo metálico.



29903504

MONOMANDOS PARA BORDE DE BAÑERA

La simplicidad y elegancia de los grifos monomando para borde de bañera se puede complementar con un depósito opcional para una instalación sin registros. El depósito es estanco y comunica con el desagüe de la bañera; incluye una placa de latón embellecedora para mejorar el acabado de la parte visible.

Acabados disponibles:

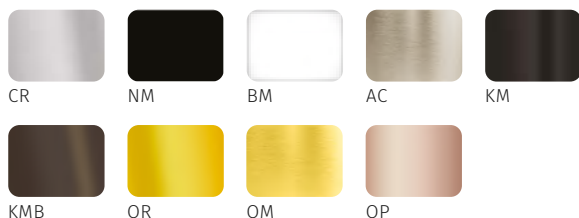



GRIFOS PARA BAÑERA

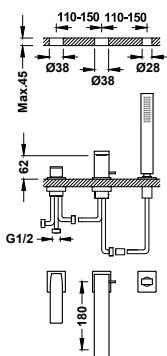

Grifo monomando para borde de bañera

- Inversor integrado en el caño de bañera.
- Ducha de mano anticalcárea de latón.
- Caño de bañera de 180 mm. Caudal: 3 bar - 13 l/m.
- Kit depósito opcional no incluido ref: 20224501.

- 20216103
- 20216103NM
- 20216103BM
- 20216103AC
- 20216103OR
- 20216103OM

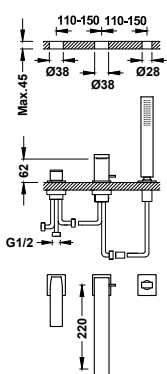

Grifo monomando para borde de bañera

- Inversor integrado en el caño de bañera.
- Ducha de mano anticalcárea de latón.
- Caño de bañera de 220 mm. Caudal: 3 bar - 13 l/m.
- Kit depósito opcional no incluido ref: 20224501.

- 20216101
- 20216101NM
- 20216101BM
- 20216101AC
- 20216101OR
- 20216101OM

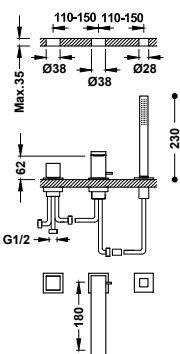

Grifo monomando para borde de bañera

- Inversor integrado en el caño de bañera.
- Ducha de mano anticalcárea de latón.
- Caño de bañera de 180 mm. Caudal: 3 bar - 13 l/min.
- Kit depósito opcional no incluido ref.: 20024501.

- 00616106

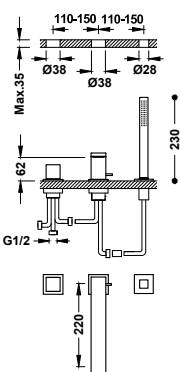

Grifo monomando para borde de bañera

- Inversor integrado en el caño de bañera.
- Ducha de mano anticalcárea de latón.
- Caño de bañera de 220 mm. Caudal: 3 bar - 13 l/min.
- Kit depósito opcional no incluido ref.: 20024501.

- 00616104



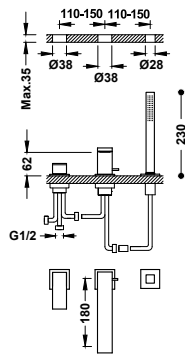

Grifo monomando para borde de bañera

- Inversor integrado en el caño de bañera.
- Ducha de mano anticalcárea de latón.
- Caño de bañera de 180 mm. Caudal: 3 bar - 13 l/m.
- Kit depósito opcional no incluido ref.: 20024501.

00616105

- 00616105NM
- 00616105BM
- 00616105AC
- 00616105OR
- 00616105OM

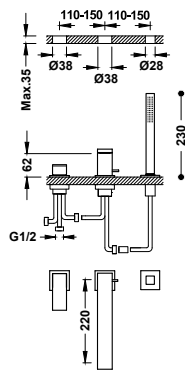

Grifo monomando para borde de bañera

- Inversor integrado en el caño de bañera.
- Ducha de mano anticalcárea de latón.
- Caño de bañera de 220 mm. Caudal: 3 bar - 13 l/m.
- Kit depósito opcional no incluido ref.: 20024501.

00616103

- 00616103NM
- 00616103BM
- 00616103AC
- 00616103OR
- 00616103OM

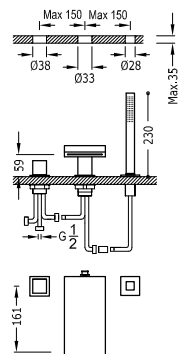

Grifo monomando para borde de bañera

- Inversor integrado en el caño de bañera.
- Ducha de mano anticalcárea de latón.
- Caño de bañera con salida del agua en cascada: 164 mm. Caudal: 3 bar -13 l/min.
- Kit depósito opcional no incluido ref.: 106245.

10716102

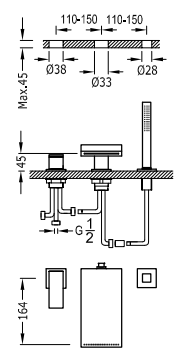

Grifo monomando para borde de bañera

- Inversor integrado en el caño de bañera.
- Ducha de mano anticalcárea de latón.
- Caño de bañera con salida del agua en cascada: 164 mm. Caudal: 3 bar -13 l/min.
- Kit depósito opcional no incluido ref.: 106245.

10616102



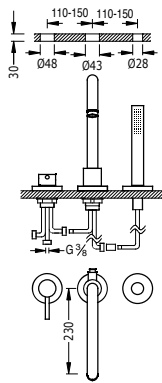

Grifo monomando para borde de bañera

- Inversor integrado en el caño de bañera.
- Ducha de mano anticalcárea de latón.
- Caudal: 3 bar - 14 l/min.
- Kit depósito opcional no incluido ref.: 162245.

26215001

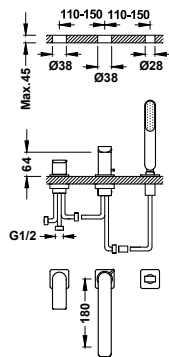

Grifo monomando para borde de bañera

- Inversor integrado en el caño de bañera.
- Ducha de mano anticalcárea.
- Caño de bañera de 180 mm. Caudal: 3 bar - 16 l/min.
- Kit depósito opcional no incluido ref.: 20324501.

20016203

- 20016203NM
- 20016203BM
- 20016203AC
- 20016203OR
- 20016203OM

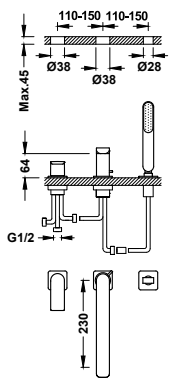

Grifo monomando para borde de bañera

- Inversor integrado en el caño de bañera.
- Ducha de mano anticalcárea.
- Caño de bañera de 220 mm. Caudal: 3 bar - 16 l/m.
- Kit depósito opcional no incluido ref.: 20324501.

20016201

- 20016201NM
- 20016201BM
- 20016201AC
- 20016201OR
- 20016201OM

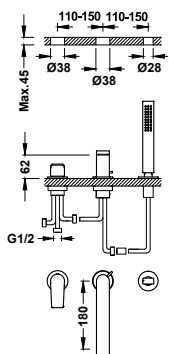

Grifo monomando para borde de bañera

- Inversor integrado en el caño de bañera.
- Ducha de mano anticalcárea de latón.
- Caño de bañera de 180 mm. Caudal: 3 bar - 13 l/min.
- Kit depósito opcional no incluido ref.: 20024501.

21116101

- 21116101NM
- 21116101BM
- 21116101AC
- 21116101KM
- 21116101KMB
- 21116101OR
- 21116101OM
- 21116101OP
- 21116101OPM



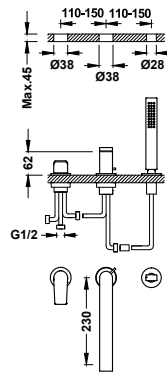

Grifo monomando para borde de bañera

- Inversor integrado en el caño de bañera.
- Ducha de mano anticalcárea de latón.
- Caño de bañera de 230 mm. Caudal: 3 bar - 13 l/min.
- Kit depósito opcional no incluido ref.: 20024501.

- 21116103
- 21116103NM
- 21116103BM
- 21116103AC
- 21116103KM
- 21116103KMB
- 21116103OR
- 21116103OM
- 21116103OP
- 21116103OPM

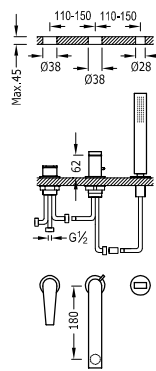

Grifo monomando para borde de bañera

- Inversor integrado en el caño de bañera.
- Ducha de mano anticalcárea.
- Caño de bañera de 180 mm. Caudal: 3 bar - 13 l/m.
- Kit depósito opcional no incluido ref.: 20024501.

- 20516103

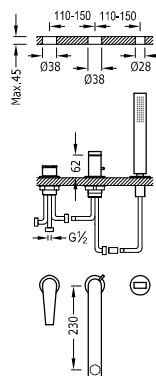

Grifo monomando para borde de bañera

- Inversor integrado en el caño de bañera.
- Ducha de mano anticalcárea.
- Caño de bañera de 230 mm. Caudal: 3 bar - 13 l/m.
- Kit depósito opcional no incluido ref.: 20024501.

- 20516101

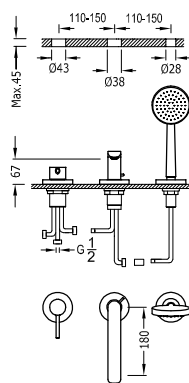

Grifo monomando para borde de bañera

- Inversor integrado en el caño de bañera.
- Ducha de mano anticalcárea: Ø 100 mm.
- Caño de bañera de 180 mm. Caudal: 3 bar - 16 l/m.
- Kit depósito opcional no incluido ref.: 20324501.

- 20316102



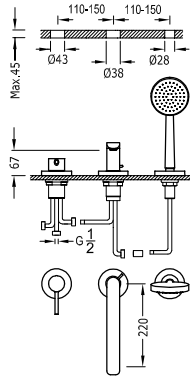

Grifo monomando para borde de bañera

- Inversor integrado en el caño de bañera.
- Ducha de mano anticalcárea: Ø 100 mm.
- Caño de bañera de 220 mm. Caudal: 3 bar - 16 l/m.
- Kit depósito opcional no incluido ref.: 20324501.

20316101

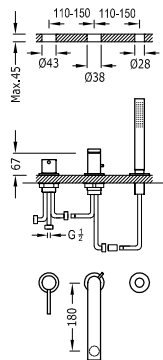

Grifo monomando para borde de bañera

- Inversor integrado en el caño de bañera.
- Ducha de mano anticalcárea de latón.
- Caño de bañera de 180 mm. Caudal: 3 bar - 16 l/m.
- Kit depósito opcional no incluido ref.: 20324501.

06216103

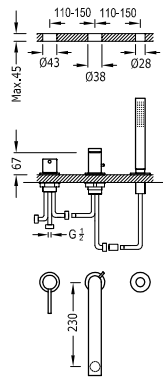

Grifo monomando para borde de bañera

- Inversor integrado en el caño de bañera.
- Ducha de mano anticalcárea de latón.
- Caño de bañera de 230 mm. Caudal: 3 bar - 16 l/m.
- Kit depósito opcional no incluido ref.: 20324501.

06216102

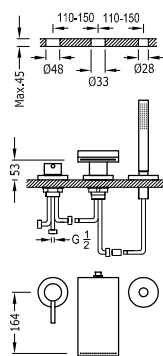

Grifo monomando para borde de bañera

- Inversor integrado en el caño de bañera.
- Ducha de mano anticalcárea de latón.
- Caño de bañera con salida del agua en cascada. Caudal: 3 bar - 17 l/m.
- Kit depósito opcional no incluido ref.: 162245.

162161



DEPÓSITOS

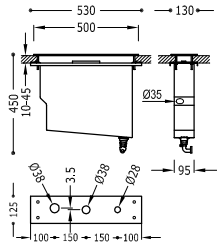

Depósito para grifería de borde de bañera

■ 20224501

Fácil montaje superior. Sin registros. Para ref.: 20216104, 20216102, 20216103, 20216101, 20266102, 20266101.

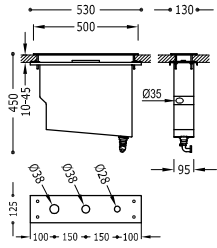

Depósito para grifería de borde de bañera

■ 20024501

Fácil montaje superior. Sin registros. Para ref.: 00616106, 00616105, 0616104, 00616103, 20516103, 20516101, 21116101, 21116103.

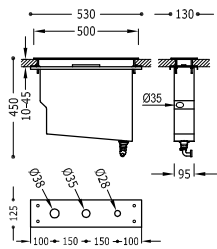

Depósito para grifería de borde de bañera

■ 106245

Fácil montaje superior. Sin registros. Para ref.: 10716102, 10616102.

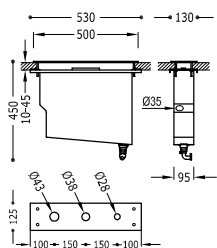

Depósito para grifería de borde de bañera

■ 20324501

Fácil montaje superior. Sin registros. Para ref.: 06216103, 06216102, 20016203, 20016201, 08116104, 08116103, 20316102, 20316101.

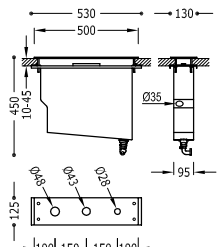

Depósito para grifería de borde de bañera

■ 162245

Fácil montaje superior. Sin registros. Para ref.: 06116101, 162161, 26115001, 26215001.

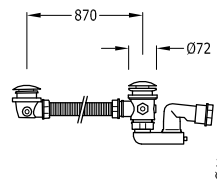

Válvula de desagüe Click-Clack para bañera con rebosadero y toma de drenaje

■ 134445

Con toma de drenaje de agua para kit de depósito. Tapón Ø 72 mm.

























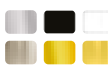

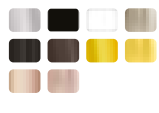





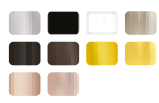





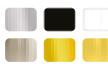

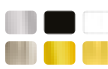

COMPLEMENTOS DE DUCHA



Rociadores empotrados a techo	362
Rociadores a techo	366
Rociadores a pared	368
Rociadores y brazos	372
Duchas de mano	381
Flexos	387
Barras deslizantes	390
Kits de ducha	399
Soportes orientables	404
Soportes con toma a pared	405
Codo adaptador a pared	407
Jets	408

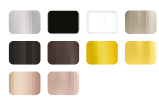













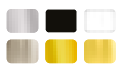
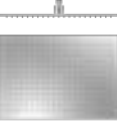
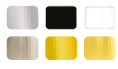





COMPLEMENTOS DE DUCHA

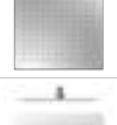



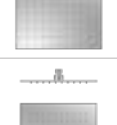
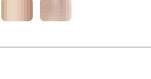
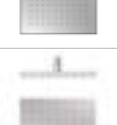



























Referencia	Página	Acabados disponibles	Empotrado a techo	A pared	A techo	Material de fabricación	Dimensiones	Salidas de agua					l/min
 29997001	362		✓			 INOX	500x650	2	18,5	16			
 29997201	362		✓			 INOX	500x650	✓	2	18,5	16		
 29997101	362		✓			 INOX	500x650	3	18,5	16	8		
 29996201	362		✓			 INOX	500x500	✓	1	14			
 29995501	363		✓			 INOX	500x500	2	20	16			
 134951	363		✓			 INOX	500x500	1	24				
 13495102	363		✓			 INOX	405x405	2	15				-
 13495101	363		✓			 INOX	405x405	1	15				
 29951607	364		✓			 INOX	420x420	1	20				
 29995301	364		✓			 INOX	380x380	1	20				
 134944	364		✓			 INOX	380x380	1	20				
 134714	364		✓			 INOX	330x330	1	11				

Referencia	Página	Acabados disponibles	Empotrado a techo	A pared	A techo	Material de fabricación	Dimensiones		Salidas de agua					l/min
 29995801	365		✓			INOX 	Ø600	✓	2	20		8		
 134950	365		✓			INOX 	Ø500		1	24				
 13495002	365		✓			INOX 	Ø405		2	15				-
 13495001	365		✓			INOX 	Ø405		1	15				
 134940	366		✓			INOX 	Ø380		1	20				
 134715	366		✓				Ø330		1	11				
 29990301	368			✓		INOX 	280x550		2	12	14			
 29990302	368			✓		INOX 	210x550		1	12,5				
 29990303	368			✓		INOX 	160x550		1	12,5				
 29990308	368			✓		INOX 	280x550		2	12	14			
 29990307	369			✓		INOX 	210x550		1	12,5				
 29990306	369			✓		INOX 	160x550		1	12,5				





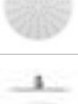







































COMPLEMENTOS DE DUCHA

Referencia	Página	Acabados disponibles	Empotrado a techo	A pared	A techo	Material de fabricación	Dimensiones	Salidas de agua	l/min				
													
 29990304	369			✓		INOX	154x200	1				16	
 29963203	372			✓	✓	INOX	450x315	1	14				
 134315008	372			✓	✓	INOX	400x250	1	16				
 29963202	372			✓	✓	INOX	320x220	1	12				
 134315007	372			✓	✓	INOX	300x200	1	12				
 134315014	372			✓	✓	INOX	400x400	1	15				
 134315012	373			✓	✓	INOX	300x300	1	12				
 134315006 134315004 134315002	373 374			✓	✓	INOX	300x300 250x250 200x200	1	12				
 13413830	373			✓	✓	INOX	300x300	1	11				
 134315011	373			✓	✓	INOX	250x250	1	12				
 13413826	374			✓	✓	ABS	250x250	1	11				

Referencia	Página	Acabados disponibles	Empotrado a techo	A pared	A techo	Material de fabricación	Dimensiones	Salidas de agua	l/min
 29943801	374			✓	✓	ABS	242x242	 12	
 29963206	374			✓	✓	ABS	220x220	 15	
 134315015	374			✓	✓	INOX	Ø400	 15	
 29933703	375			✓	✓		Ø310	 11	
 134315010	375			✓	✓	INOX	Ø300	 12	
 134315005 134315003	375			✓	✓	INOX	Ø300 Ø250	 12	
 13413730	375			✓	✓		Ø300	 11	
 134315009	376			✓	✓	INOX	Ø250	 12	
 13413726	376			✓	✓	ABS	Ø250	 11	
 13431513	376			✓	✓	ABS	Ø225	 12	
 134315001	376			✓	✓	INOX	Ø200	 12	



COMPLEMENTOS DE DUCHA

Referencia	Página	Acabados disponibles	Material de fabricación	Dimensiones	Número de funciones								l/min
 20263901	381				1	9,5							
 29963108	381				1	12							
 00663901	381				1	9,5							
 03463901	381				1	13							
 03411601	381				1	9,5							
 913412380	382				1	12							
 29974901	382			Ø110	5	10	12,5	12	12,5	10			
 29974904	382			Ø130	3	7	8	5					
 29974905	383			Ø110	3	8,8	9,6	8,8					
 29963115	382			Ø110	5	17	17	11	17	10			
 29963112	383			Ø110	3	8,5							8,5
 29963113	383			96x110	3	8,5							8,5

Referencia	Página	Acabados disponibles	Material de fabricación	Dimensiones	Número de funciones	l/min								
														
 29974906	383		 ABS	107x107	3	8,2	8,6	8,1						
 29963111	383		 ABS	120x120	3	10	14	9						
 134612	384		 ABS	80x80	1	15								
 29963109	384		 ABS	Ø78	1	10								
 29963110	384		 ABS	Ø100	1	16								
 29963114	384		 ABS	Ø100	3	14	14	10						
 29963105	384		 ABS	Ø110	1	10								
 29963106	385		 ABS	Ø110	5	10	10	8,5		8,5	9,5			
 134748	385		 ABS	Ø100	5	16	16,5	15,5	16	11				
 29974802	385		 ABS	Ø100	1	9,5								
 9134725	385		 ABS	Ø77	1	7,5								
 134617	385		 ABS	Ø80	1	15,5								
 134627	386		 ABS	Ø80	2	15				7				





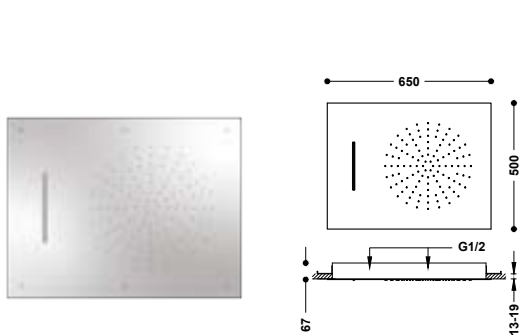



ROCIADORES EMPOTRADOS A TECHO



Rociador de ducha empotrado a techo

Con 2 tipos de chorro (lluvia/cascada). Alimentación mediante 2 vías de agua independientes. Dimensiones: 500x650 mm. Material: Acero inoxidable. Boquillas anticalcáreas.

-  29997001
-  29997001NM
-  29997001BM
-  29997001AC
-  29997001OR
-  29997001OM

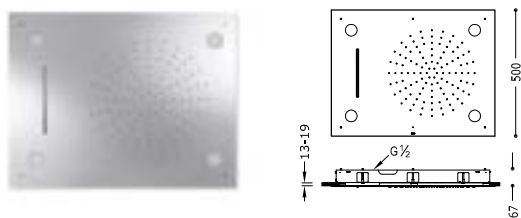
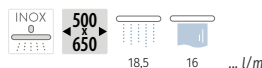

Rociador de ducha empotrado a techo con Cromoterapia

Con 2 tipos de chorro (lluvia/cascada). Alimentación mediante 2 vías de agua independientes. Dimensiones: 500x650 mm. Material: Acero inoxidable. Boquillas anticalcáreas. Las luces LED se activan con un interruptor (no incluido).

-  29997201

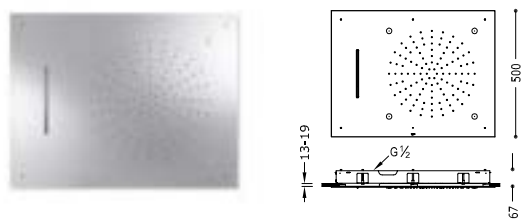

Rociador de ducha empotrado a techo

Con 3 tipos de chorro (lluvia/cascada/micro drop). Alimentación mediante 3 vías de agua independientes. Dimensiones: 500x650 mm. Material: Acero inoxidable. Boquillas anticalcáreas.

-  29997101

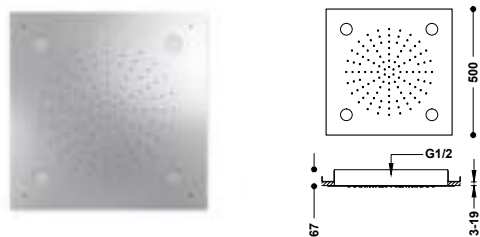
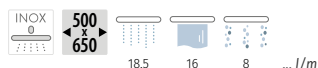

Rociador de ducha empotrado a techo con Cromoterapia

Dimensiones: 500x500 mm. Material: Acero inoxidable. Boquillas anticalcáreas. Las luces LED se activan automáticamente o con un interruptor (no incluido).

-  29996201

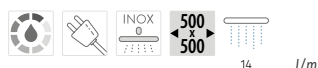

Rociador de ducha empotrado a techo





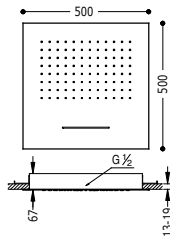

Con 2 tipos de chorro (lluvia/cascada). Alimentación mediante 2 vías de agua independientes. Dimensiones: 500x500 mm. Material: Acero inoxidable. Boquillas anticalcáreas.

-  29995501
-  29995501NM
-  29995501BM
-  29995501AC



Rociador de ducha empotrado a techo





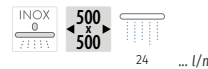
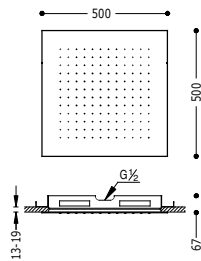





Dimensiones: 500x500 mm. Material: Acero inoxidable. Boquillas anticalcáreas.

-  134951
-  134951NM
-  134951BM
-  134951AC
-  134951OR
-  134951OM



Rociador de ducha empotrado a techo





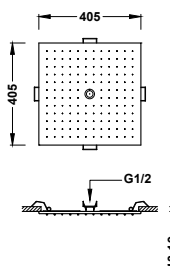
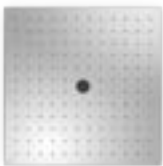





Con 2 tipos de chorro (lluvia/free flow). Alimentación mediante 2 vías de agua independientes. Dimensiones: 405x405 mm. Material: Acero inoxidable. Boquillas anticalcáreas.

-  13495102
-  13495102NM
-  13495102BM
-  13495102AC
-  13495102KM
-  13495102KMB
-  13495102OR
-  13495102OM
-  13495102OP
-  13495102OPM



Rociador de ducha empotrado a techo

Dimensiones: 405x405 mm. Material: Acero inoxidable. Boquillas anticalcáreas.

-  13495101
-  13495101NM
-  13495101BM
-  13495101AC
-  13495101KM
-  13495101KMB
-  13495101OR
-  13495101OM
-  13495101OP
-  13495101OPM

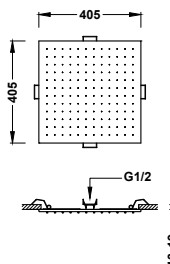

Rociador de ducha empotrado a techo

Dimensiones: 420x420 mm. Material: Acero inoxidable.
Boquillas anticalcáreas.

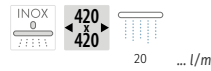
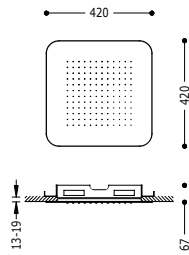

29951607

- 29951607NM
- 29951607BM
- 29951607AC
- 29951607OR
- 29951607OM

Rociador de ducha empotrado a techo

Dimensiones: 380x380 mm. Material: Acero inoxidable.
Boquillas anticalcáreas.

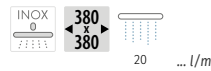
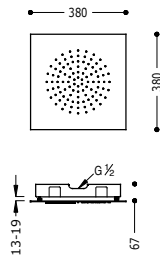

29995301

- 29995301NM
- 29995301BM
- 29995301AC
- 29995301OR
- 29995301OM

Rociador de ducha empotrado a techo

Dimensiones: 380x380 mm. Material: Acero inoxidable.
Boquillas anticalcáreas.

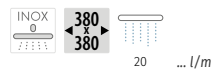
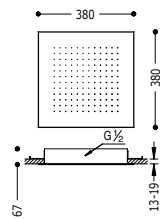
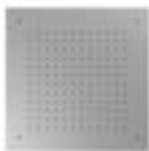

134944

- 134944NM
- 134944BM
- 134944AC
- 134944OR
- 134944OM

Rociador de ducha empotrado a techo

Dimensiones: 332x332 mm. Material latón. Boquillas anticalcáreas.

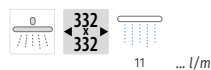
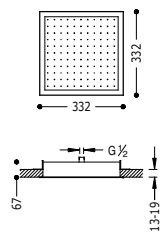

134714

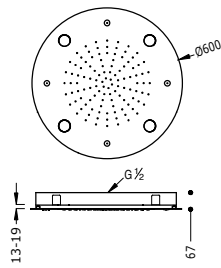

Rociador de ducha empotrado a techo con Cromoterapia

Con 2 tipos de chorro (lluvia/Micro drop). Alimentación mediante 2 vías de agua independientes. Dimensiones: Ø 600 mm. Material: Acero inoxidable. Boquillas anticálcáreas. Las luces LED se activan con un interruptor (no incluido).

■ 29995801

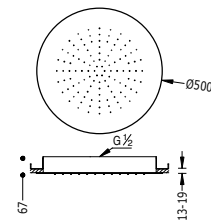

Rociador de ducha empotrado a techo

Dimensiones: Ø 500 mm. Material: Acero inoxidable. Boquillas anticálcáreas.

■ 134950

- 134950NM
- 134950BM
- 134950AC
- 134950OR
- 134950OM

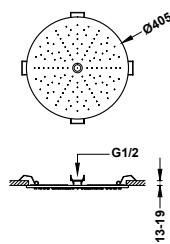
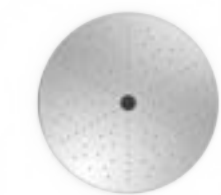
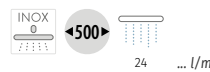

Rociador de ducha empotrado a techo

Con 2 tipos de chorro (lluvia/free flow). Alimentación mediante 2 vías de agua independientes. Dimensiones: Ø 405 mm. Material: Acero inoxidable. Boquillas anticálcáreas.

■ 13495002

- 13495002NM
- 13495002BM
- 13495002AC
- 13495002KM
- 13495002KMB
- 13495002OR
- 13495002OM
- 13495002OP
- 13495002OPM

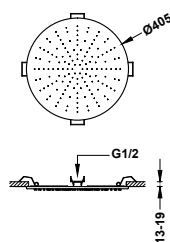

Rociador de ducha empotrado a techo

Dimensiones: Ø 405 mm. Material: Acero inoxidable. Boquillas anticálcáreas.

■ 13495001

- 13495001NM
- 13495001BM
- 13495001AC
- 13495001KM
- 13495001KMB
- 13495001OR
- 13495001OM
- 13495001OP
- 13495001OPM



Rociador de ducha empotrado a techo

Dimensiones: Ø 380 mm. Material: Acero inoxidable.
Boquillas anticalcáreas.

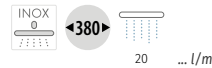
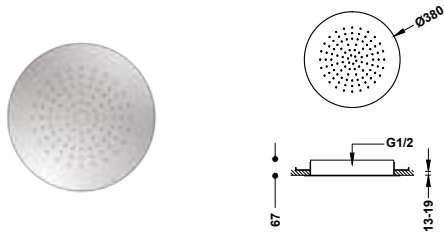

- 134940
- 134940NM
- 134940BM
- 134940AC
- 134940KM
- 134940KMB
- 134940OR
- 134940OM
- 134940OP
- 134940OPM

Rociador de ducha empotrado a techo

Dimensiones: Ø 332 mm. Material latón. Boquillas anticalcáreas.

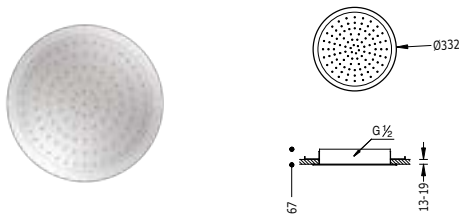

- 134715

ROCIADORES A TECHO

Brazo a techo con rociador de ducha orientable

Brazo a techo: 157 mm. Rociador de ducha orientable: 450x315 mm.
Material: Latón.

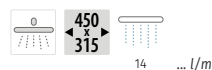

- 03443203

Brazo a techo con rociador de ducha orientable

Brazo a techo: 141 mm. Rociador de ducha orientable: 300x200 mm.
Material: Acero inoxidable.

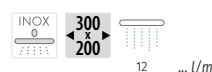

- 03443202

Brazo a techo con rociador de ducha orientable

03483102

Brazo a techo: 157 mm. Rociador de ducha orientable: 300x300 mm.
Material: Latón.

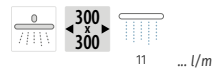

Brazo a techo con rociador de ducha orientable

03412102

Brazo a techo: 166 mm. Rociador de ducha orientable: 250x250 mm.

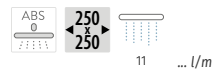

Brazo a techo con rociador de ducha orientable

134331

Brazo a techo: 153 mm. Rociador de ducha orientable: Ø 300 mm.
Material: Acero inoxidable.

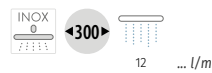

Brazo a techo con rociador de ducha orientable

134221

Brazo a techo: 155 mm. Rociador de ducha orientable: Ø 250 mm.



ROCIADORES A PARED

Rociador de ducha a pared

Con 2 tipos de chorro (lluvia/cascada). Alimentación mediante 2 vías de agua independientes. Dimensiones: 280x550 mm. Material: Acero inoxidable. Boquillas anticálcarea.

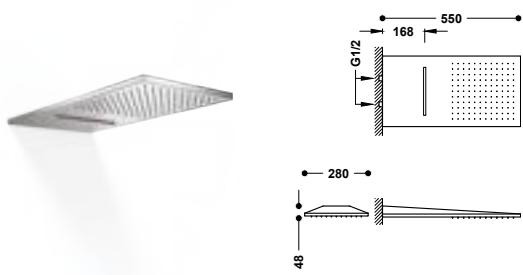

- 29990301
- 29990301NM
- 29990301BM
- 29990301AC
- 29990301OR
- 29990301OM

Rociador de ducha a pared

Dimensiones: 210x550 mm. Material: Acero inoxidable. Boquillas anticálcarea.

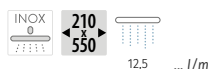
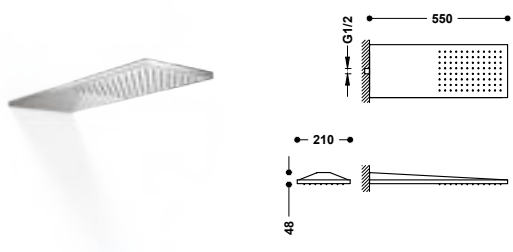

- 29990302
- 29990302NM
- 29990302BM
- 29990302AC
- 29990302OR
- 29990302OM

Rociador de ducha a pared

Dimensiones: 160x550 mm. Material: Acero inoxidable. Boquillas anticálcarea.

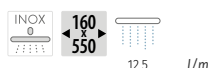
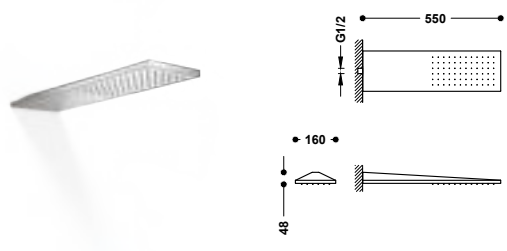

- 29990303
- 29990303NM
- 29990303BM
- 29990303AC
- 29990303KM
- 29990303KMB
- 29990303OR
- 29990303OM
- 29990303OP
- 29990303OPM

Rociador de ducha a pared

Con 2 tipos de chorro (lluvia/cascada). Alimentación mediante 2 vías de agua independientes. Dimensiones: 280x550 mm. Material: Acero inoxidable. Boquillas anticálcarea.

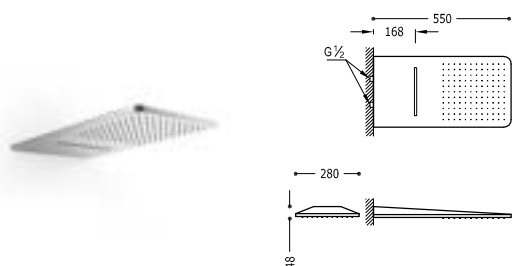

- 29990308
- 29990308NM
- 29990308BM
- 29990308AC

Rociador de ducha a pared

Dimensiones: 210x550 mm. Material: Acero inoxidable.
Boquillas anticalcáreas.

29990307

- 29990307NM
- 29990307BM
- 29990307AC
- 29990307KM
- 29990307KMB
- 29990307OR
- 29990307OM
- 29990307OP
- 29990307OPM

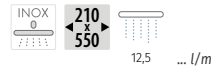
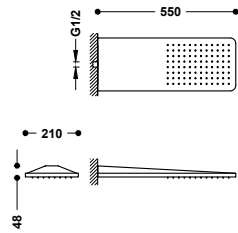

Rociador de ducha a pared

Dimensiones: 160x550 mm. Material: Acero inoxidable.
Boquillas anticalcáreas.

29990306

- 29990306NM
- 29990306BM
- 29990306AC
- 29990306OR
- 29990306OM

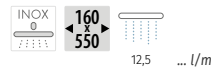
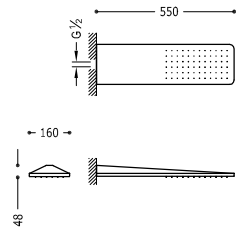

Rociador de ducha a pared

Con salida del agua en cascada. Material: Acero inoxidable.
Dimensiones: 154x200 mm.

29990304

- 29990304NM
- 29990304BM
- 29990304AC
- 29990304OR
- 29990304OM

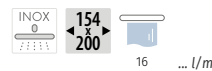
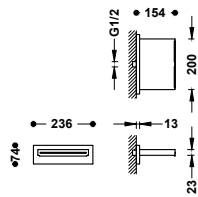

Brazo a pared con rociador de ducha orientable

Brazo a pared: 400 mm. Rociador de ducha orientable: 300x200 mm.
Material: Acero inoxidable.

29953202

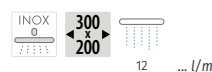
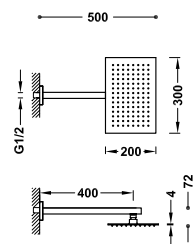

Brazo a pared con rociador de ducha orientable

134433

Brazo a pared: 400 mm. Rociador de ducha orientable: 300x300 mm.
Material: Acero inoxidable.

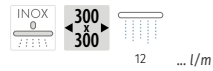
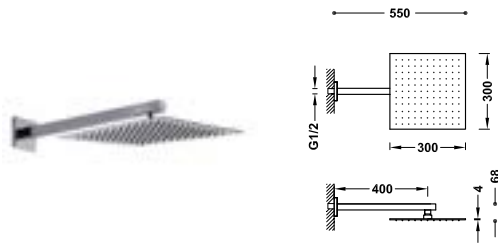

Brazo a pared con rociador de ducha orientable

134233

Brazo a pared: 400 mm. Rociador de ducha orientable: 250x250 mm.

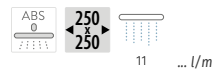
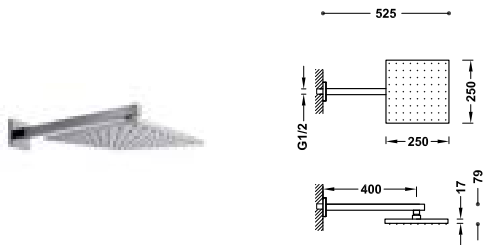

Brazo a pared con rociador de ducha orientable

03443101

Brazo a pared: 400 mm. Rociador de ducha orientable: 300x300 mm.
Material: Latón.

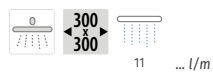
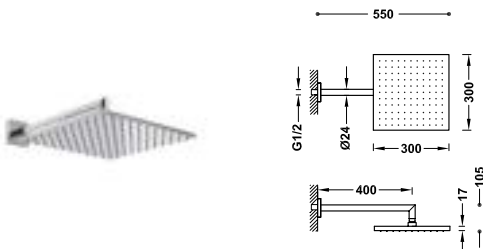

Brazo a pared con rociador de ducha orientable

03423101

Brazo a pared: 400 mm. Rociador de ducha orientable: 250x250 mm.

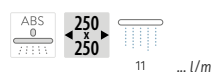
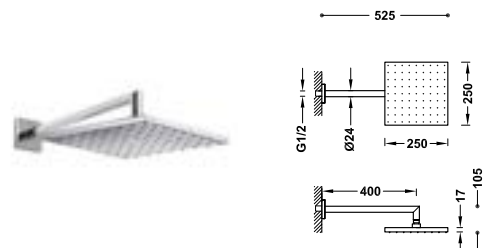

Brazo a pared con rociador de ducha orientable

134432

Brazo a pared: 400 mm. Rociador de ducha orientable: \varnothing 300 mm.
Material: Acero inoxidable.

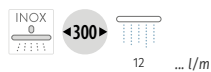
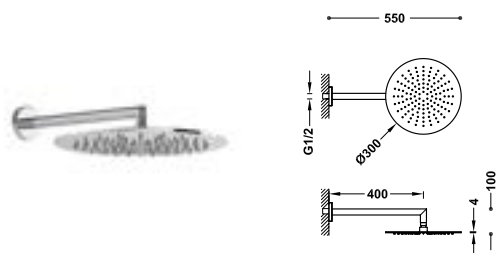

Brazo a pared con rociador de ducha orientable

134232

Brazo a pared: 400 mm. Rociador de ducha orientable: \varnothing 250 mm.

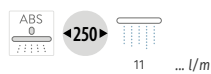
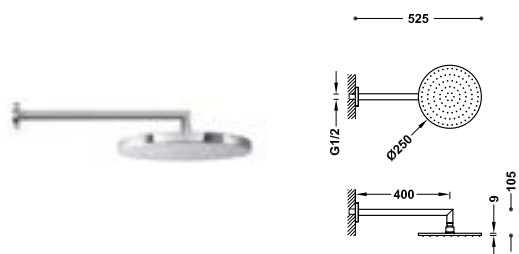

ROCIADORES Y BRAZOS

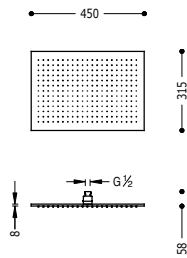

Rociador de ducha

Dimensiones: 450x315 mm. Rótula orientable. Material: Latón. Boquillas anticalcáreas.

29963203

- 29963203NM
- 29963203BM
- 29963203AC
- 29963203OR
- 29963203OM

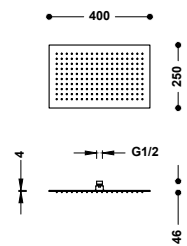
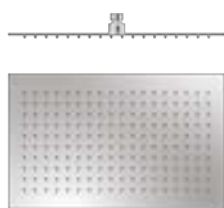
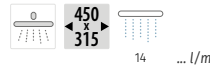

Rociador de ducha

Extrafino: 4 mm. Dimensiones: 400x250 mm. Rótula orientable. Material: Acero inoxidable. Boquillas anticalcáreas.

134315008

- 134315008NM
- 134315008BM
- 134315008AC
- 134315008OR
- 134315008OM

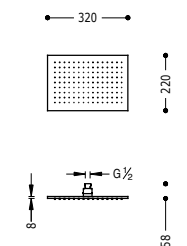
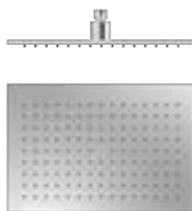
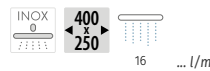

Rociador de ducha

Dimensiones: 320x220 mm. Rótula orientable. Material: Latón. Boquillas anticalcáreas.

29963202

- 29963202NM
- 29963202BM
- 29963202AC
- 29963202OR
- 29963202OM

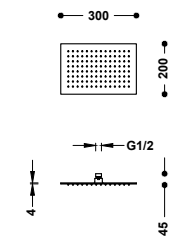
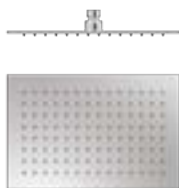
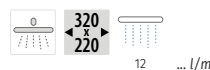

Rociador de ducha

Extrafino: 4 mm. Dimensiones: 300x200 mm. Rótula orientable. Material: Acero inoxidable. Boquillas anticalcáreas.

134315007

- 134315007NM
- 134315007BM
- 134315007AC
- 134315007KMB
- 134315007OR
- 134315007OM
- 134315007OP
- 134315007OPM

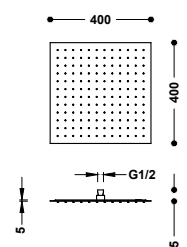
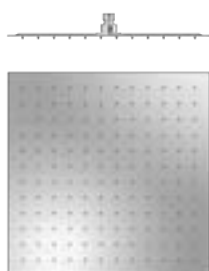
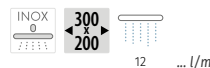

Rociador de ducha

Dimensiones: 400x400 mm. Rótula orientable. Material: Acero inoxidable. Incorpora una válvula de alivio de presión de membrana. Boquillas anticalcáreas.

134315014



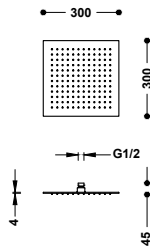
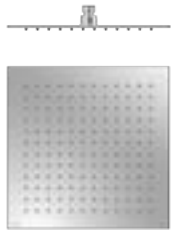

Rociador de ducha

Extrafino: 4 mm. Dimensiones: 300x300 mm. Rótula orientable. Material: Acero inoxidable. Boquillas anticalcáreas.

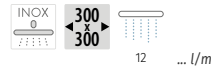

- 134315012
- 134315012NM
- 134315012BM
- 134315012AC
- 134315012KM
- 134315012KMB
- 134315012OR
- 134315012OM
- 134315012OP
- 134315012OPM

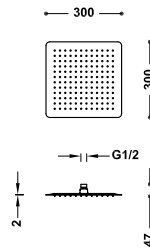

Rociador de ducha

Dimensiones: 300x300 mm. Rótula orientable. Material: Acero inoxidable. Boquillas anticalcáreas.

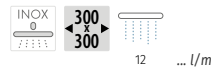

- 134315006

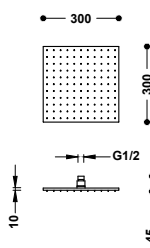
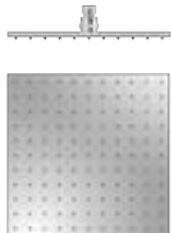

Rociador de ducha

Dimensiones: 300x300 mm. Rótula orientable. Material: Latón. Boquillas anticalcáreas.

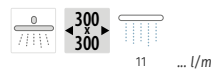

- 13413830
- 13413830NM
- 13413830BM
- 13413830AC
- 13413830KM
- 13413830KMB
- 13413830OR
- 13413830OM
- 13413830OP
- 13413830OPM

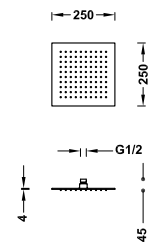
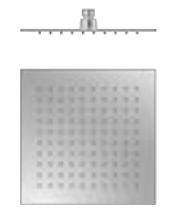

Rociador de ducha

Extrafino: 4 mm. Dimensiones: 250x250 mm. Rótula orientable. Material: Acero inoxidable. Boquillas anticalcáreas.

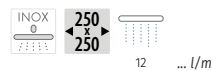

- 134315011

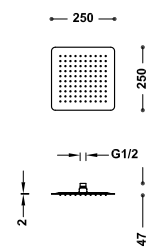

Rociador de ducha

Dimensiones: 250x250 mm. Rótula orientable. Material: Acero inoxidable. Boquillas anticalcáreas.

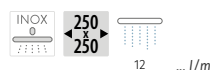

- 134315004

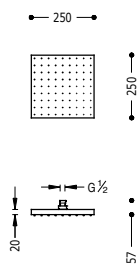

Rociador de ducha

Dimensiones: 250x250 mm. Rótula orientable. Boquillas anticalcáreas.

13413826

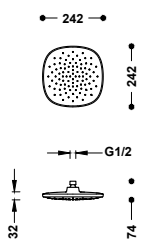
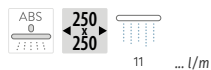

Rociador de ducha

Dimensiones: 242x242 mm. Rótula orientable. Boquillas anticalcáreas.

29943801

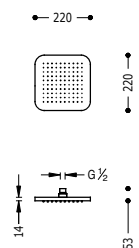
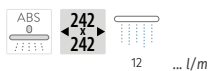

Rociador de ducha

Dimensiones: 220x220 mm. Rótula orientable. Boquillas anticalcáreas.

29963206

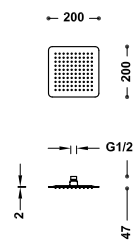
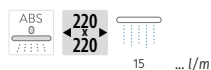

Rociador de ducha

Dimensiones: 200x200 mm. Rótula orientable. Material: Acero inoxidable. Boquillas anticalcáreas.

134315002

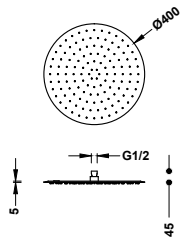
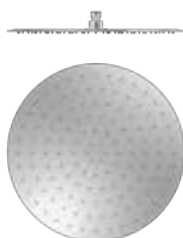
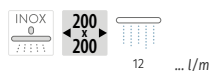

Rociador de ducha

Dimensiones: Ø 400 mm. Rótula orientable. Material: Acero inoxidable. Incorpora una válvula de alivio de presión de membrana. Boquillas anticalcáreas.

134315015



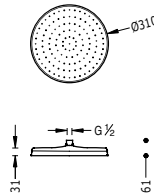

Rociador de ducha

Dimensiones: Ø 310 mm. Rótula orientable. Material: Latón.
Boquillas anticálcáreas.

■ 29933703

- 29933703AC
- 29933703OR
- 29933703LV
- 29933703LM

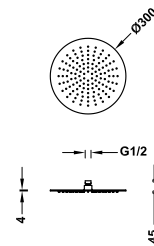
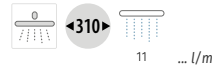

Rociador de ducha

Extrafino: 4 mm. Dimensiones: Ø 300 mm. Rótula orientable. Material: Acero inoxidable. Boquillas anticálcáreas.

■ 134315010

- 134315010NM
- 134315010BM
- 134315010AC
- 134315010KM
- 134315010KMB
- 134315010OR
- 134315010OM
- 134315010OP
- 134315010PM

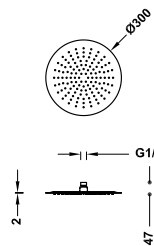

Rociador de ducha

Dimensiones: Ø 300 mm. Rótula orientable. Material: Acero inoxidable. Boquillas anticálcáreas.

■ 134315005

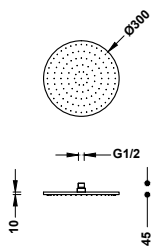
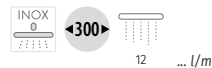

Rociador de ducha

Dimensiones: Ø 300 mm. Rótula orientable. Material: Latón. Boquillas anticálcáreas.

■ 13413730

- 13413730NM
- 13413730BM
- 13413730AC
- 13413730KM
- 13413730KMB
- 13413730OR
- 13413730OM
- 13413730OP
- 13413730OPM

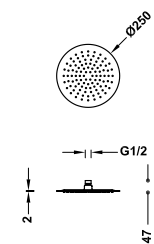
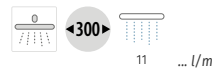

Rociador de ducha

Dimensiones: Ø 250 mm. Rótula orientable. Material: Acero inoxidable. Boquillas anticálcáreas.

■ 134315003

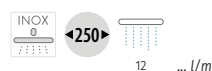

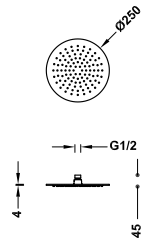

Rociador de ducha

Extrafino: 4 mm. Dimensiones: Ø 250 mm. Rótula orientable. Material: Acero inoxidable. Boquillas anticalcáreas.

134315009

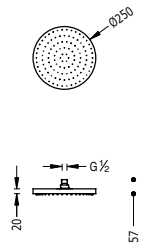
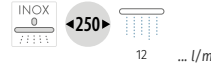

Rociador de ducha

Dimensiones: Ø 250 mm. Rótula orientable. Boquillas anticalcáreas.

13431726



BOQUILLAS ANTICALCÁREAS AUTOLIMPIABLES

Cada vez que se cierra el grifo, unas pequeñas púas tapan las boquillas para limpiarlas y dejarlas libres cuando vuelva a salir el agua.

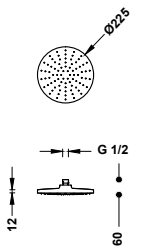

Rociador de ducha

Dimensiones: Ø 225 mm. Rótula orientable. Boquillas anticalcáreas autolimpiables.

13431513

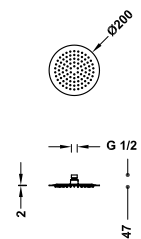
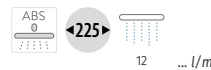

Rociador de ducha

Dimensiones: Ø 200 mm. Rótula orientable. Material: Acero inoxidable. Boquillas anticalcáreas.

134315001

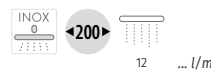

Brazo a pared

Para rociador de ducha. Longitud: 300 mm.

13462101

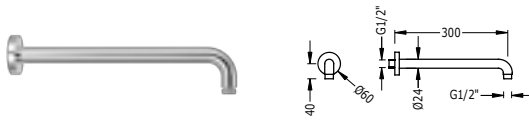

Brazo a pared

Para rociador de ducha. Longitud: 400 mm.

13413940

- 13413940NM
- 13413940BM
- 13413940AC
- 13413940OR
- 13413940OM

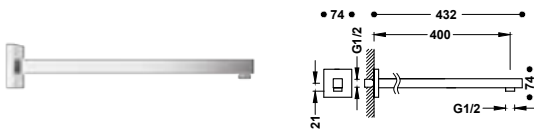

Brazo a pared

Para rociador de ducha. Longitud: 400 mm.

13462104

- 13462104NM
- 13462104BM
- 13462104AC
- 13462104KM
- 13462104KMB
- 13462104OR
- 13462104OM
- 13462104OP
- 13462104OPM

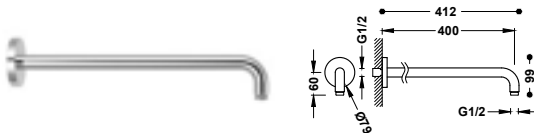

Brazo a pared

Para rociador de ducha. Longitud: 390 mm.

13463302

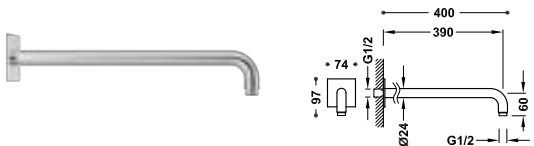

Brazo a pared

Para rociador de ducha. Longitud: 390 mm.

13463303

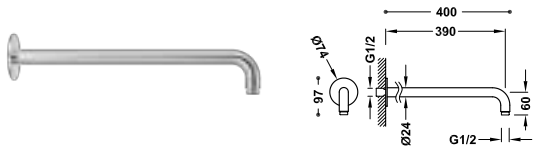

Brazo a pared

Para rociador de ducha. Longitud: 390 mm.

13463301

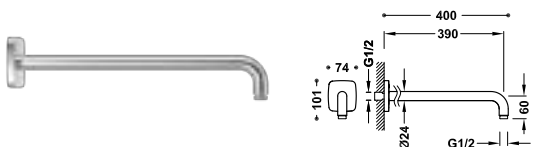

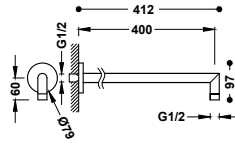

Brazo a pared

Para rociador de ducha. Longitud: 400 mm.

16118740

- 16118740NM
- 16118740BM
- 16118740AC
- 16118740KMB
- 16118740OR
- 16118740OM
- 16118740OP
- 16118740OPM

N

N

N

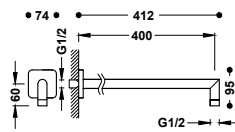

Brazo a pared

Para rociador de ducha. Longitud: 400 mm.

29963902

- 29963902NM
- 29963902BM
- 29963902AC
- 29963902KMB
- 29963902OR
- 29963902OM
- 29963902OP
- 29963902OPM

N

N

N

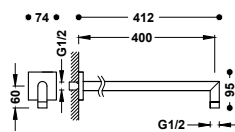

Brazo a pared

Para rociador de ducha. Longitud: 400 mm.

06243201

- 06243201NM
- 06243201BM
- 06243201AC
- 06243201KM
- 06243201KMB
- 06243201OR
- 06243201OM
- 06243201OP
- 06243201OPM

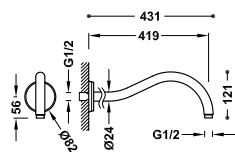

Brazo a pared

Para rociador de ducha. Longitud: 419 mm.

29933701

- 29933701AC
- 29933701OR
- 29933701LV
- 29933701LM

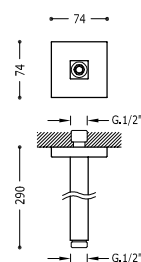

Brazo a techo

Para rociador de ducha. Longitud: 290 mm.

13462202

- 13462202NM
- 13462202BM
- 13462202AC
- 13462202OR
- 13462202OM

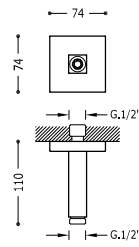

Brazo a techo

Para rociador de ducha. Longitud: 110 mm.

13452202

- 13452202NM
- 13452202BM
- 13452202AC
- 13452202OR
- 13452202OM

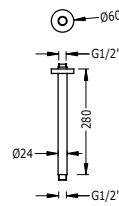

Brazo a techo

Para rociador de ducha. Longitud: 280 mm.

13462102

- 13462102NM
- 13462102BM
- 13462102AC
- 13462102KMB
- 13462102OR
- 13462102OM
- 13462102OP
- 13462102OPM



N
N
N

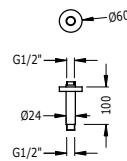

Brazo a techo

Para rociador de ducha. Longitud: 100 mm.

13452102

- 13452102NM
- 13452102BM
- 13452102AC
- 13452102KM
- 13452102KMB
- 13452102OR
- 13452102OM
- 13452102OP
- 13452102OPM

N

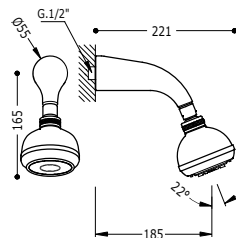

Brazo a pared con rociador de ducha orientable

Rociador de ducha orientable: Ø 93 mm. 3 tipos de chorro.

134818

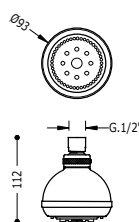

Rociador de ducha

Rótula orientable. Dimensiones: Ø 93 mm. 3 tipos de chorro.

913481810

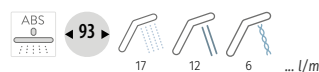

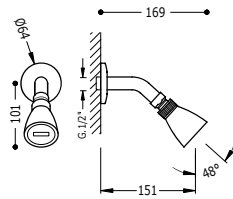

Brazo a pared con rociador de ducha orientable
Rociador de ducha orientable: Ø 54 mm.

134738

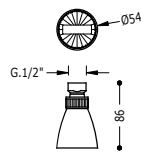

Rociador de ducha
Rótula orientable. Dimensiones: Ø 54 mm.

913473810

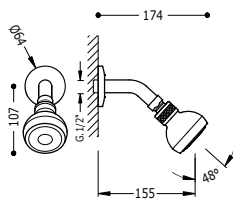

Brazo a pared con rociador de ducha orientable
Rociador de ducha orientable: Ø 70 mm. Boquillas anticálcarea.

134808

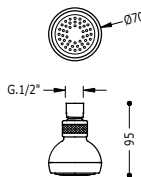

Rociador de ducha
Rótula orientable. Dimensiones: Ø 70 mm. Boquillas anticálcarea.

913480810

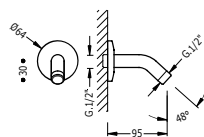

Brazo a pared para rociador de ducha
Para rociador de ducha. Longitud: 95 mm.

13473850

DUCHAS DE MANO

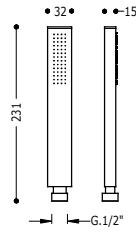

Ducha de mano
Material: Latón. Boquillas anticalcáreas.

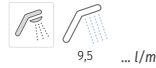

- 20263901
- 20263901NM
- 20263901BM
- 20263901AC
- 20263901KM
- 20263901KMB
- 20263901OR
- 20263901OM
- 20263901OP
- 20263901OPM

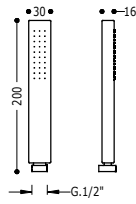

Ducha de mano
Boquillas anticalcáreas.



- 29963108

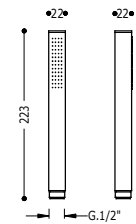

Ducha de mano
Material: Latón. Boquillas anticalcáreas.

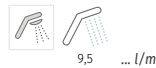

- 00663901
- 00663901NM
- 00663901BM
- 00663901AC
- 00663901KMB
- 00663901OR
- 00663901OM
- 00663901OP
- 00663901OPM

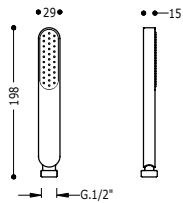

Ducha de mano
Boquillas anticalcáreas.



- 03463901
- 03463901NM
- 03463901BM
- 03463901AC
- 03463901KMB
- 03463901OR
- 03463901OM
- 03463901OP
- 03463901OPM
- 03463901NE
- 03463901BL

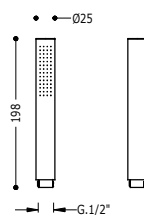

Ducha de mano
Material: Latón. Boquillas anticalcáreas.

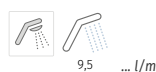

- 03411601
- 03411601NM
- 03411601BM
- 03411601AC
- 03411601KM
- 03411601KMB
- 03411601OR
- 03411601OM
- 03411601OP
- 03411601OPM

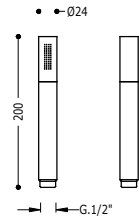

Ducha de mano
Material: Latón.

913412380

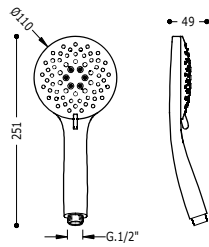
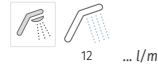

Ducha de mano

Con 5 tipos de chorro. Medida: Ø 110 mm. Boquillas anticalcáreas.

29974901

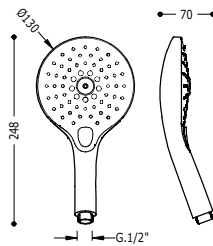
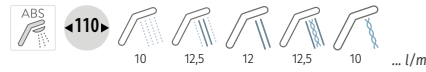

Ducha de mano

Con 3 tipos de chorro. Medida: Ø 130 mm. Boquillas anticalcáreas.

29974904



BOQUILLAS ANTICALCÁREAS AUTOLIMPIABLES

Al cambiar de función moviendo la palanca, las púas limpian cada boquilla para que no quede cal incrustada.

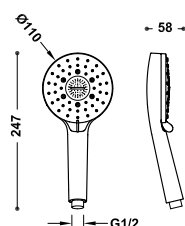
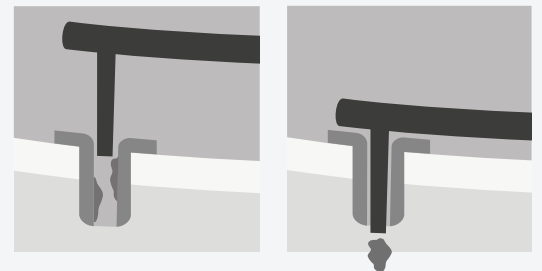

Ducha de mano

Dimensiones: Ø 110 mm. 5 tipos de chorro. Boquillas anticalcáreas autolimpiables.

29963115

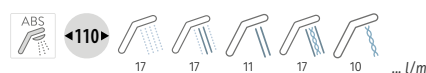

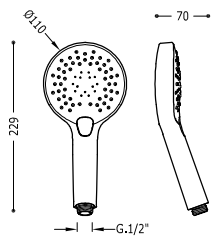

Ducha de mano

Con 3 tipos de chorro. Medida: Ø 110 mm. Boquillas anticalcáreas.

29974905

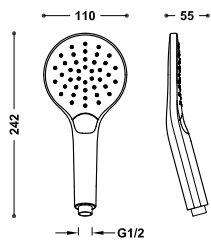
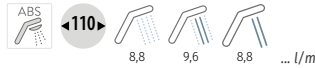

Ducha de mano ECO-DROP

Con 3 tipos de chorro. Medida: Ø 110 mm. Boquillas anticalcáreas.

29963112

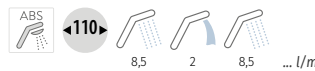

- 29963112NM
- 29963112BM
- 29963112AC
- 29963112KM
- 29963112KMB
- 29963112OR
- 29963112OM
- 29963112OP
- 29963112OPM

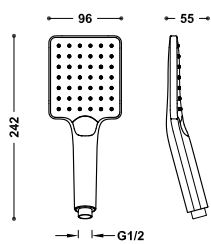

Ducha de mano ECO-DROP

Con 3 tipos de chorro. Medida: 96x110 mm. Boquillas anticalcáreas.

29963113

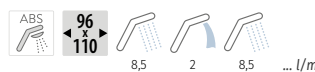

- 29963113NM
- 29963113BM
- 29963113AC
- 29963113KM
- 29963113KMB
- 29963113OR
- 29963113OM
- 29963113OP
- 29963113OPM

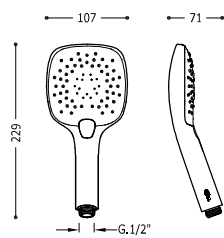

Ducha de mano

Con 3 tipos de chorro. Medida: 107x107 mm. Boquillas anticalcáreas.

29974906

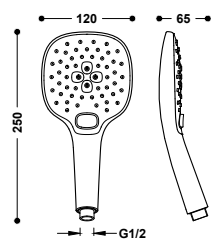
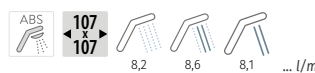

Ducha de mano

Dimensiones: 120x120 mm. 3 tipos de chorro. Boquillas anticalcáreas.

29963111

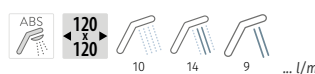

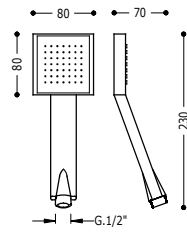

Ducha de mano

Medida: 80x80 mm. Boquillas anticalcáreas.

134612

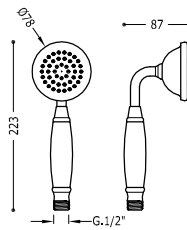
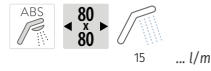

Ducha de mano

Mango cerámico. Dimensiones: Ø 78 mm. Material: Latón. Boquillas anticalcáreas.

29963109

- 29963109AC
- 29963109OR
- 29963109LV
- 29963109LM

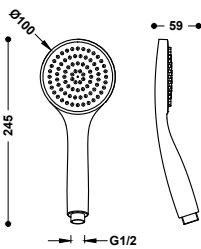
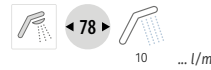

Ducha de mano

Dimensiones: Ø 100 mm. Boquillas anticalcáreas.

29963110

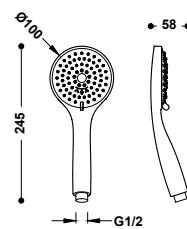

Ducha de mano

Dimensiones: Ø 100 mm. 3 tipos de chorro. Boquillas anticalcáreas.

29963114

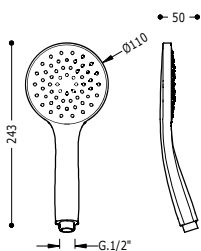
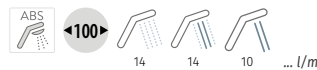

Ducha de mano

Dimensiones: Ø 110 mm. Boquillas anticalcáreas.

29963105



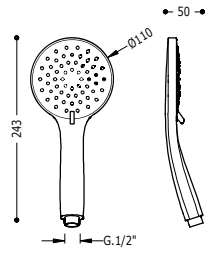

Ducha de mano

Dimensiones: Ø 110 mm. 5 tipos de chorro. Boquillas anticalcáreas.

29963106

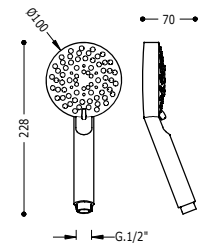
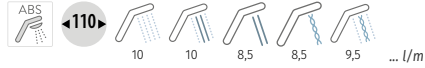

Ducha de mano

Dimensiones: Ø 100 mm. 5 tipos de chorro. Boquillas anticalcáreas.

134748

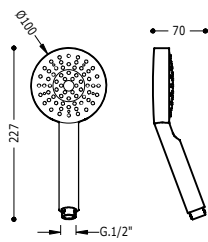
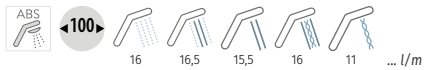

Ducha de mano

Dimensiones: Ø 100 mm.

29974802

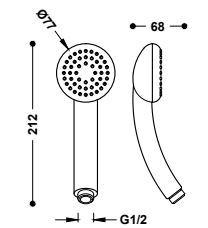

Ducha de mano

Dimensiones: Ø 77 mm. Boquillas anticalcáreas.

9134725

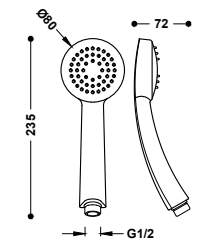

Ducha de mano

Dimensiones: Ø 80 mm. Boquillas anticalcáreas.

134617

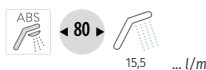

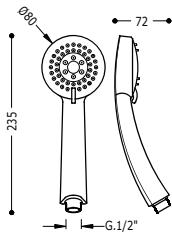

Ducha de mano

Dimensiones: Ø 80 mm. 2 tipos de chorro. Boquillas anticalcáreas.

134627

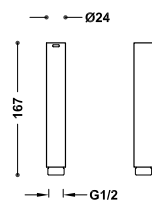
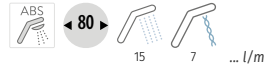

Ducha de mano para grifo de inodoro

Con record limitador: 5 l/min. Para ref.: 34122, 34123, 81122, 81123, 81222, 81223, 62122, 62123, 006123, 205222, 205223, 217123, 281123.

29912390

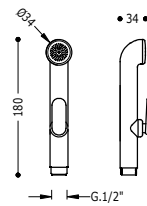

Ducha de mano con cierre para grifo de inodoro

Con record limitador: 8 l/min. Para ref.: 81113, 62113, 20311301.

29911351

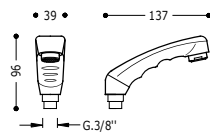

Ducha de mano para grifo de peluquería

9134450



FLEXOS

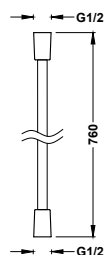

Flexo satinado

Long.: 0,76 m. Diámetro: Ø 14,5 mm. Giratorio antitorsión.

913460910

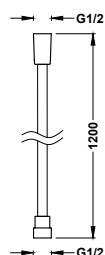

Flexo satinado

Long.: 1,20 m. Diámetro: Ø 14,5 mm. Giratorio antitorsión.

913460912

- 913460912NM
- 913460912BM
- 913460912AC

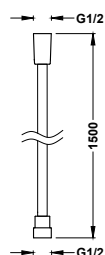

Flexo satinado

Long.: 1,50 m. Diámetro: Ø 14,5 mm. Giratorio antitorsión.

913460915

- 913460915NM
- 913460915BM
- 913460915AC
- 913460915KM
- 913460915KMB
- 913460915OR
- 913460915OM
- 913460915OP
- 913460915OPM

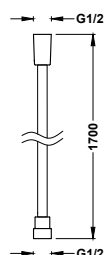

Flexo satinado

Long.: 1,70 m. Diámetro: Ø 14,5 mm. Giratorio antitorsión.

9134609

- 9134609NM
- 9134609BM
- 9134609AC
- 9134609KM
- 9134609KMB
- 9134609OR
- 9134609OM
- 9134609OP
- 9134609OPM

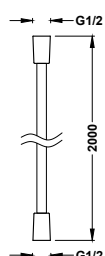

Flexo satinado

Long.: 2,00 m. Diámetro: Ø 14,5 mm. Giratorio antitorsión.

913460920

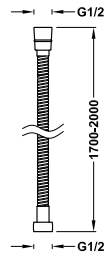

Flexo metálico extensible

Long: 1,70 m. Diámetro: Ø 14 mm. Material: Acero inoxidable.

9134630

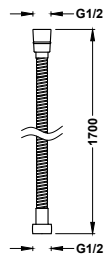

Flexo metálico reforzado

Long: 1,70 m. Tuerca cónica con junta tórica y arandela prisionera en racor. Garantía de diez años.

9134828

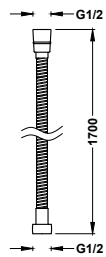

Flexo metálico reforzado y extensible

Long: 1,70 m. Tuerca cónica con junta tórica y arandela prisionera en racor. Garantía de diez años.

913483080

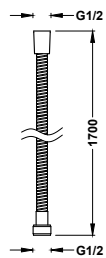

Flexo metálico

Long: 1,70 m.

9134830053

9134830054

9134830051

913483005LM

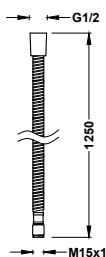

Flexo metálico reforzado

Long: 1,25 m. Diámetro: Ø 12 mm. Para ref.: 30444, 41443, 41444, 44444, 50443, 52444, 54444, 70443, 72443, 73443, 73444, 39444, 69444.

9134867

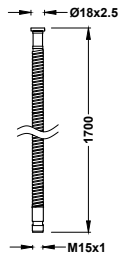

Flexo metálico

Long.: 1,70 m. Diámetro: Ø 12 mm. Para ref.: 30430, 30432, 30433, 14444, 43444, 87444, 130460, 62438, 30452, 81438.

9134712

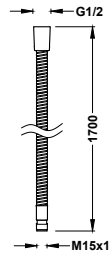

Flexo metálico reforzado

Long.: 1,70 m. Tuerca cónica con junta tórica y arandela prisionera en racor. Garantía de diez años. Para ref.: 06161, 07161, 14150, 17145, 39145, 41145, 43145, 43147, 44145, 43147, 44145, 61150, 61161, 61181, 62150, 62161, 63145, 63181, 69145, 72145, 73145, 74145, 85145, 87150, 87161, 87181, 89150, 70145, 81150, 81161, 89161, 200161, 200162, 202161, 202661, 203161, 205161, 261150, 262150.

9134881

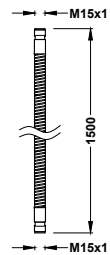

Flexo metálico

Long.: 1,50 m. Para ref.: 145 CLASICTRES, MONOCLASIC 1900, RETROTRES.

9134731

9134731051

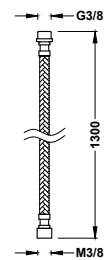

Flexo para ducha de peluquería

Long.: 1,30 m. Para ref.: 72450. Material: Nylon negro.

9134887

BARRAS DESLIZANTES

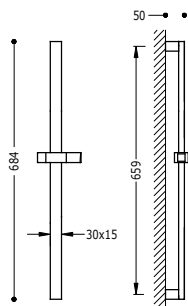

Barra deslizante para ducha

Barra de ducha de latón: long. 659 mm. Soporte deslizante y orientable para ducha de mano.

134516

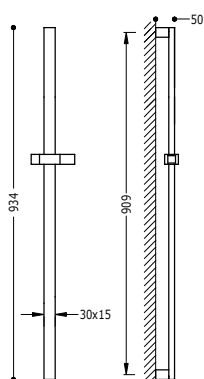

Barra deslizante para ducha

Barra de ducha de latón: long. 909 mm. Soporte deslizante y orientable para ducha de mano.

134517

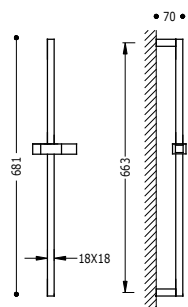

Barra deslizante para ducha

Barra de ducha de latón: long. 663 mm. Soporte deslizante y orientable para ducha de mano.

107922

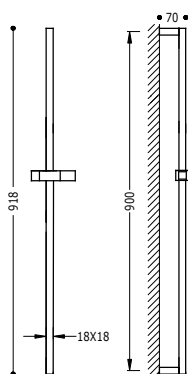

Barra deslizante para ducha

Barra de ducha de latón: long. 900 mm. Soporte deslizante y orientable para ducha de mano.

134520

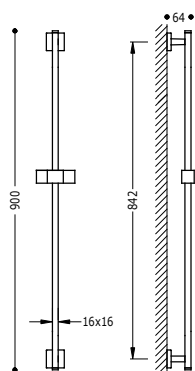

Barra deslizante para ducha

Barra de ducha de latón: long. 842 mm. Soporte deslizante y orientable para ducha de mano.

107935

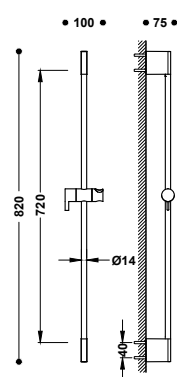

Barra deslizante para ducha

Barra de ducha: long. 800 mm y \varnothing 14 mm. Soporte deslizante y orientable para ducha de mano.

03463701

- 03463701NM
- 03463701BM
- 03463701AC

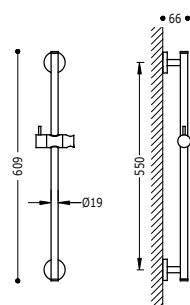

Barra deslizante para ducha

Barra de ducha: long. 550 mm y \varnothing 19 mm. Soporte deslizante y orientable para ducha de mano.

134618

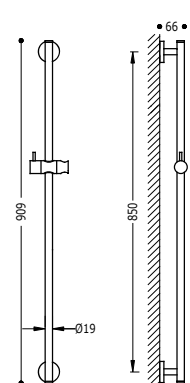

Barra deslizante para ducha

Barra de ducha: long. 850 mm y \varnothing 19 mm. Soporte deslizante y orientable para ducha de mano.

134619



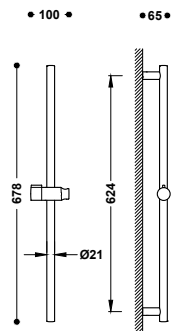

Barra deslizante para ducha

Barra de ducha: long. 624 mm y Ø 20.6 mm. Soporte deslizante y orientable para ducha de mano.

03463702

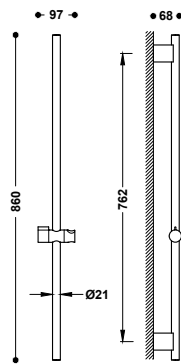

Barra deslizante para ducha

Barra de ducha: long. 762 mm y Ø 20,6 mm. Soporte deslizante y orientable para ducha de mano.

03463708

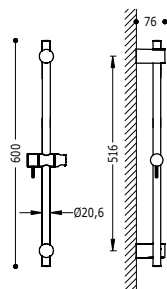

Barra deslizante para ducha

Barra de ducha con fijaciones regulables en altura: long. 516 mm y Ø 20,6 mm. Soporte deslizante y orientable para ducha de mano.

161835

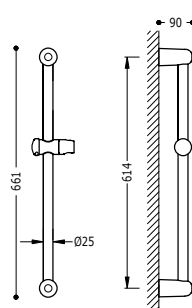

Barra deslizante para ducha

Barra de ducha: long. 614 mm y Ø 25 mm. Soporte deslizante y orientable para ducha de mano.

143835

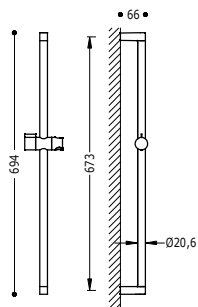

Barra deslizante para ducha

Barra de ducha: long. 673 mm y Ø 20,6 mm. Soporte deslizante y orientable para ducha de mano.

03463706

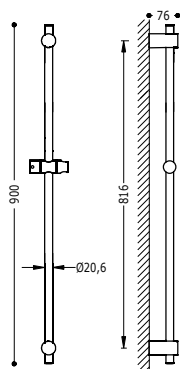

Barra deslizante para ducha

Barra de ducha con fijaciones regulables en altura: long. 816 mm y Ø 20,6 mm. Soporte deslizante y orientable para ducha de mano.

161838

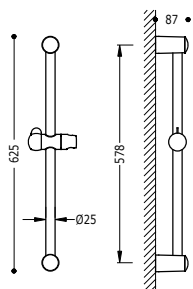

Barra deslizante para ducha

Barra de ducha: long. 578 mm y Ø 25 mm. Soporte deslizante y orientable para ducha de mano.

134835

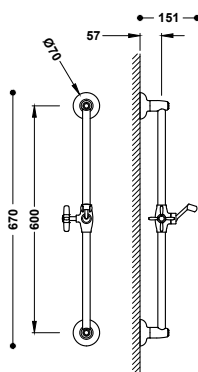

Barra deslizante para ducha

Barra de ducha: 600 mm y Ø 20,6 mm. Soporte deslizante y orientable para ducha de mano.

24273201

24273201AC

24273201LV

24273201LM



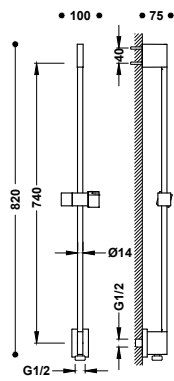

Barra deslizante para ducha con toma de agua a pared

Barra de ducha: 740 mm y Ø 14 mm. Soporte deslizante y orientable para ducha de mano.

03493299

03493299NM

03493299BM

03493299AC

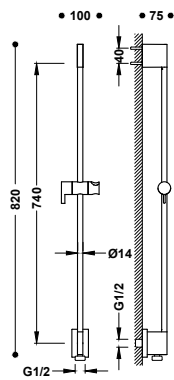

Barra deslizante para ducha con toma de agua a pared

Barra de ducha: 740 mm y Ø 14 mm. Soporte deslizante y orientable para ducha de mano.

03493199

03493199NM

03493199BM

03493199AC

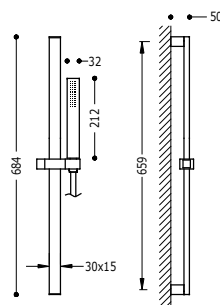

Conjunto de barra de ducha

Barra de ducha de latón: long. 659 mm. Soporte deslizante y orientable para ducha de mano. Ducha de mano anticalcárea de latón. Flexo satinado.

03452602

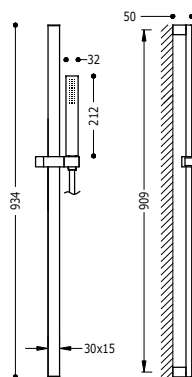

Conjunto de barra de ducha

Barra de ducha de latón: long. 909 mm. Soporte deslizante y orientable para ducha de mano. Ducha de mano anticalcárea de latón. Flexo satinado.

03452702



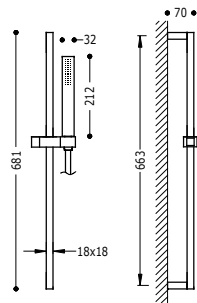

Conjunto de barra de ducha

Barra de ducha de latón: long. 663 mm. Soporte deslizante y orientable para ducha de mano. Ducha de mano anticalcárea de latón. Flexo satinado.

03433603

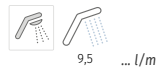

9,5 ... l/m

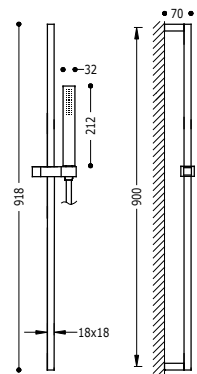

Conjunto de barra de ducha

Barra de ducha de latón: long. 900 mm. Soporte deslizante y orientable para ducha de mano. Ducha de mano anticalcárea de latón. Flexo satinado.

03433604

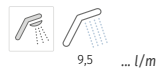

9,5 ... l/m

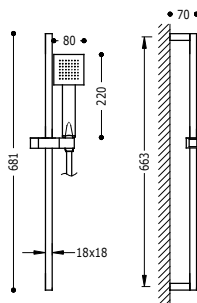

Conjunto de barra de ducha

Barra de ducha de latón: long. 663 mm. Soporte deslizante y orientable para ducha de mano. Ducha de mano anticalcárea. Flexo satinado.

134512

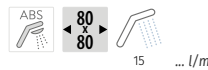

15 ... l/m

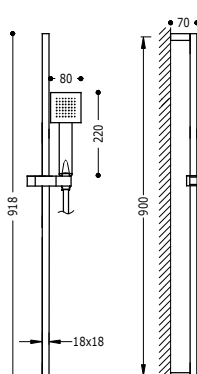

Conjunto de barra de ducha

Barra de ducha de latón: long. 900 mm. Soporte deslizante y orientable para ducha de mano. Ducha de mano anticalcárea. Flexo satinado.

134522

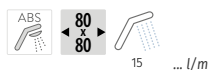

15 ... l/m



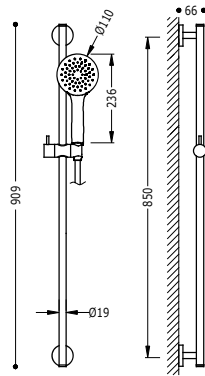

Conjunto de barra de ducha

Barra de ducha: long. 850 mm y Ø 19 mm. Soporte deslizante y orientable para ducha de mano. Ducha de mano anticalcárea. Flexo satinado.

06192801

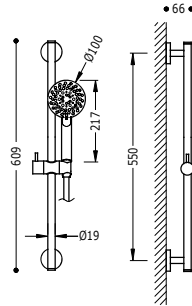

Conjunto de barra de ducha

Barra de ducha: long. 550 mm y Ø 19 mm. Soporte deslizante y orientable para ducha de mano. Ducha de mano anticalcárea: Ø 100 mm. (5 tipos de chorro). Flexo satinado.

134628

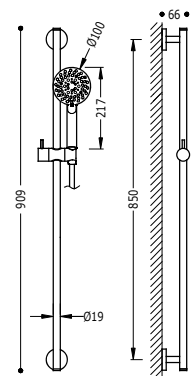
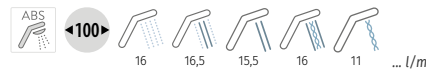

Conjunto de barra de ducha

Barra de ducha: long. 850 mm y Ø 19 mm. Soporte deslizante y orientable para ducha de mano. Ducha de mano anticalcárea: Ø 100 mm. (5 tipos de chorro). Flexo satinado.

134629

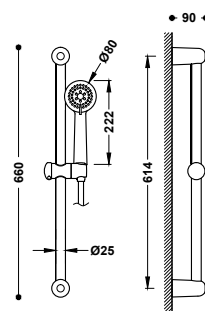
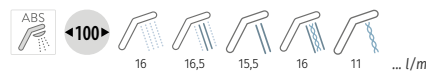

Conjunto de barra de ducha

Barra de ducha: long. 614 mm y Ø 25 mm. Soporte deslizante y orientable para ducha de mano. Ducha de mano anticalcárea: Ø 80 mm. (2 tipos de chorro). Flexo satinado.

143836

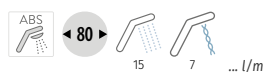

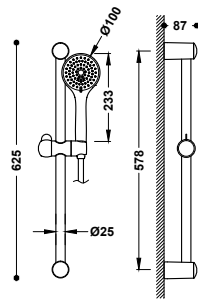

Conjunto de barra de ducha

Barra de ducha: long. 578 mm y Ø 25 mm. Soporte deslizante y orientable para ducha de mano Ø 100 mm. (3 tipos de chorro). Ducha de mano anticálcarea. Flexo satinado.

134923

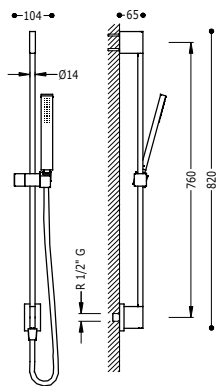

Conjunto de barra de ducha con toma de agua a pared

Barra de ducha: 760 mm y Ø 14 mm. Soporte deslizante y orientable para ducha de mano. Ducha de mano anticálcarea de latón. Flexo satinado.

03493201

03493201NM

03493201BM

03493201AC

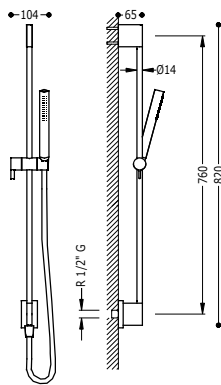

Conjunto de barra de ducha con toma de agua a pared

Barra de ducha: 760 mm y Ø 14 mm. Soporte deslizante y orientable para ducha de mano. Ducha de mano anticálcarea de latón. Flexo satinado.

03493101

03493101NM

03493101BM

03493101AC

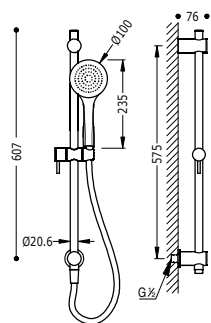
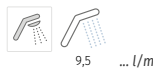

Conjunto de barra de ducha con toma de agua a pared

Soporte con toma de agua a pared. Barra de ducha: long. 575 mm y Ø 20,6 mm. Soporte deslizante y orientable para ducha de mano. Ducha de mano anticálcarea. Flexo satinado.

06193103



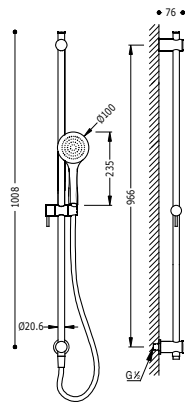

Conjunto de barra de ducha con toma de agua a pared
 Soporte con toma de agua a pared. Barra de ducha: long. 966 mm y Ø 20,6 mm. Soporte deslizante y orientable para ducha de mano. Ducha de mano anticalcárea. Flexo satinado.

06193105

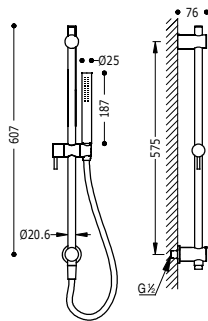

Conjunto de barra de ducha con toma de agua a pared
 Soporte con toma de agua a pared. Barra de ducha: long. 575 mm y Ø 20,6 mm. Soporte deslizante y orientable para ducha de mano. Ducha de mano anticalcárea de latón. Flexo satinado.

06193102

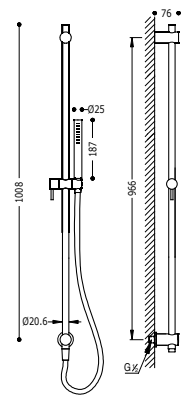
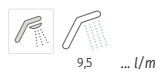

Conjunto de barra de ducha con toma de agua a pared
 Soporte con toma de agua a pared. Barra de ducha: long. 966 mm y Ø 20,6 mm. Soporte deslizante y orientable para ducha de mano. Ducha de mano anticalcárea de latón. Flexo satinado.

06193104



KITS DE DUCHA

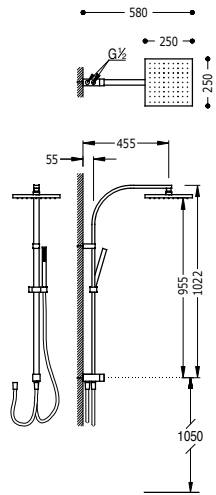
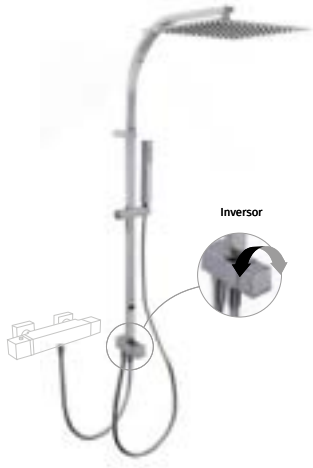

Conjunto de ducha adaptable a cualquier grifo

107926

- Con inversor integrado en la barra de ducha.
- Rociador de ducha orientable de acero inoxidable: 250x250 mm.
- Soporte deslizante y orientable para ducha de mano.
- Ducha de mano anticalcárea de latón.
- Flexo satinado.

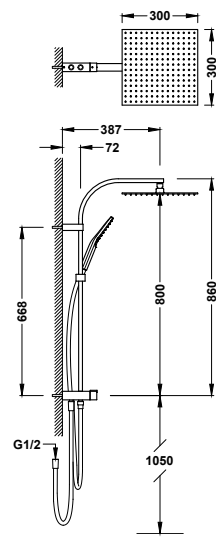
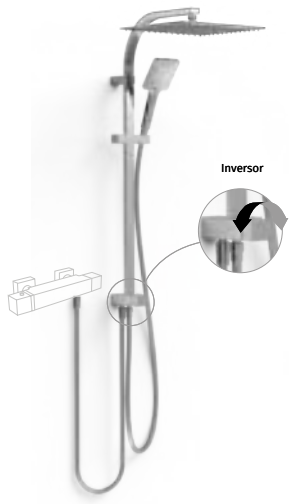
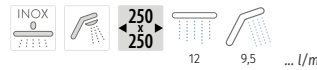

Conjunto de ducha adaptable a cualquier grifo

19063504

- Con inversor integrado en la barra de ducha.
- Rociador de ducha orientable de acero inoxidable: 300x300 mm.
- Soporte deslizante y orientable para ducha de mano.
- Ducha de mano anticalcárea: 96x110 mm. (3 tipos de chorro).
- Flexo satinado.

- 19063504NM
- 19063504BM
- 19063504AC
- 19063504OM

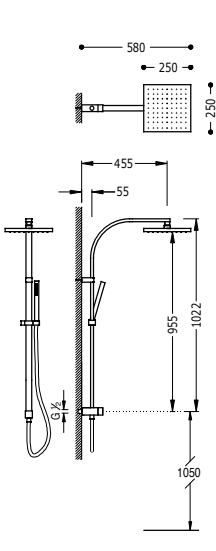
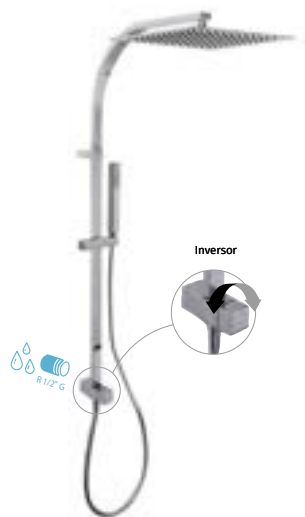

Conjunto de barra de ducha sin grifo con toma de agua y rociador

107131

- Con inversor integrado en la barra de ducha.
- Rociador de ducha orientable de acero inoxidable: 250x250 mm.
- Soporte deslizante y orientable para ducha de mano.
- Ducha de mano anticalcárea de latón.
- Flexo satinado.

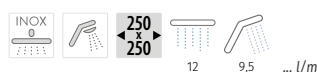

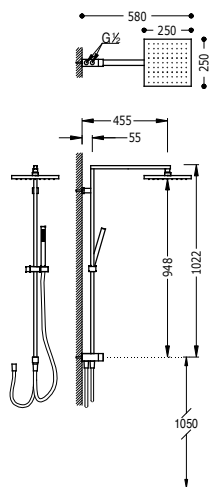
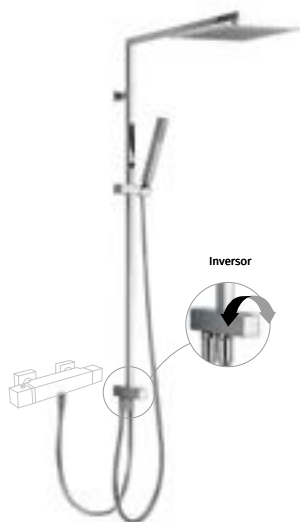

Conjunto de ducha adaptable a cualquier grifo

107476

- Con inversor integrado en la barra de ducha.
- Rociador de ducha orientable de acero inoxidable: 250x250 mm.
- Soporte deslizante y orientable para ducha de mano.
- Ducha de mano anticalcárea de latón.
- Flexo satinado.

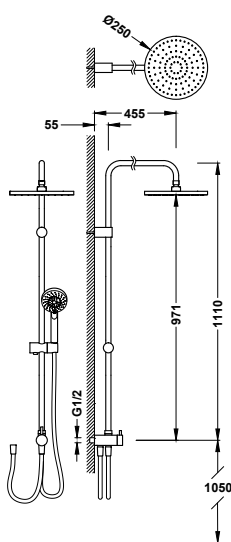
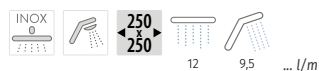

Conjunto de ducha adaptable a cualquier grifo

161475

- Con inversor integrado en la barra de ducha.
- Rociador de ducha orientable de acero inoxidable: Ø 250 mm.
- Soporte deslizante y orientable para ducha de mano.
- Ducha de mano anticalcárea: Ø 100 mm. (5 tipos de chorro).
- Flexo satinado.

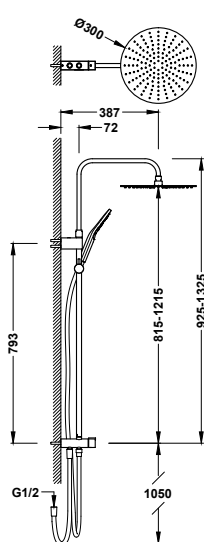

Conjunto de ducha adaptable a cualquier grifo

19063502

- Con inversor integrado en la barra de ducha.
- Rociador de ducha orientable de acero inoxidable: Ø 300 mm.
- Soporte deslizante y orientable para ducha de mano.
- Ducha de mano anticalcárea: Ø 110 mm. (3 tipos de chorro).
- Flexo satinado.

- 19063502NM
- 19063502BM
- 19063502KMB
- 19063502OM
- 19063502OPM

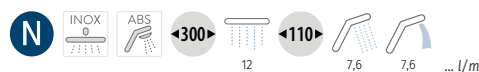

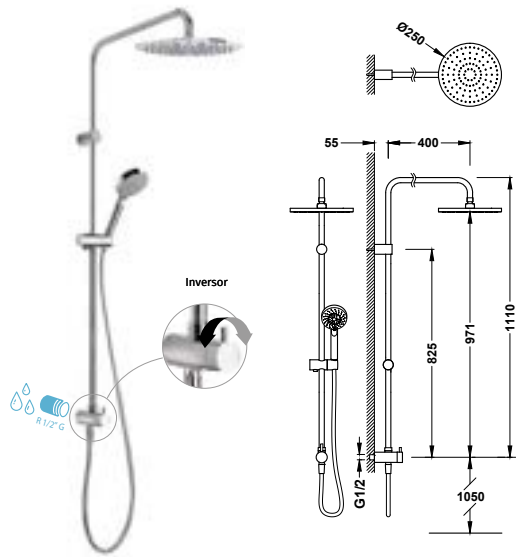

Conjunto de barra de ducha sin grifo con toma de agua y rociador

06163505

- Con inversor integrado en la barra de ducha.
- Rociador de ducha orientable de acero inoxidable: Ø 250 mm.
- Soporte deslizante y orientable para ducha de mano.
- Ducha de mano anticalcárea: Ø 100 mm. (5 tipos de chorro).
- Flexo satinado.

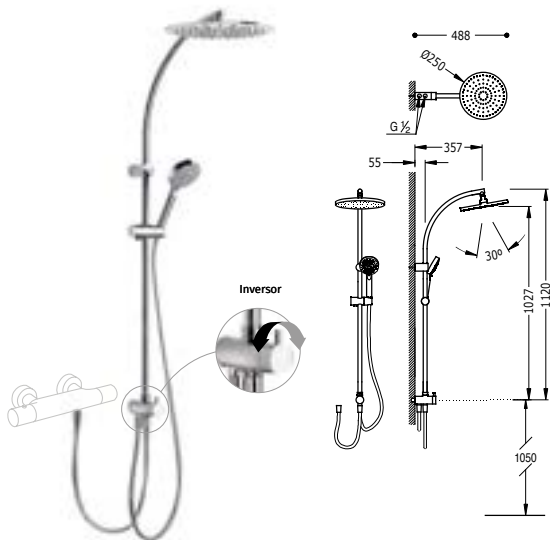

Conjunto de ducha adaptable a cualquier grifo

161476

- Con inversor integrado en la barra de ducha.
- Rociador de ducha orientable de acero inoxidable: Ø 250 mm.
- Soporte deslizante y orientable para ducha de mano.
- Ducha de mano anticalcárea: Ø 100 mm. (5 tipos de chorro).
- Flexo satinado.

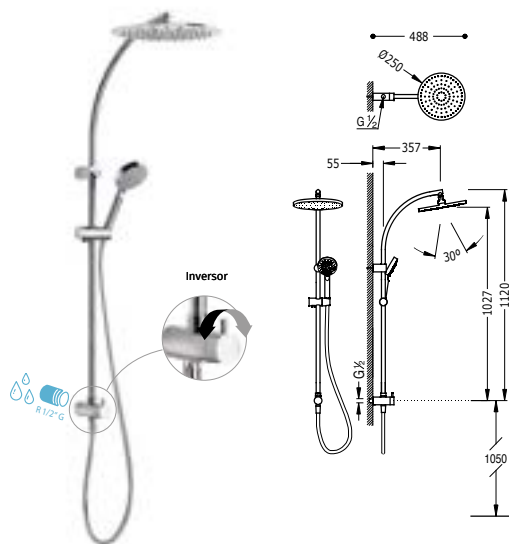
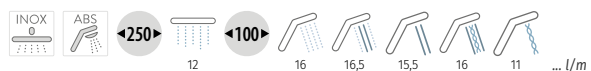

Conjunto de barra de ducha sin grifo con toma de agua y rociador

06163504

- Con inversor integrado en la barra de ducha.
- Rociador de ducha orientable de acero inoxidable: Ø 250 mm.
- Soporte deslizante y orientable para ducha de mano.
- Ducha de mano anticalcárea: Ø 100 mm. (5 tipos de chorro).
- Flexo satinado.

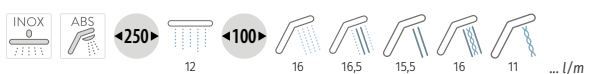

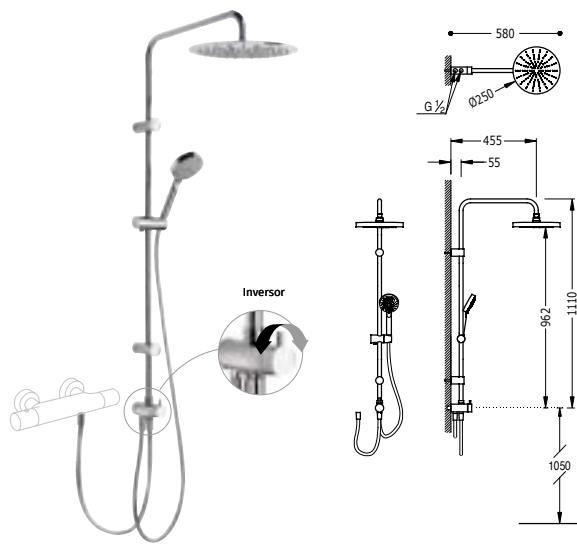

Conjunto de ducha adaptable a cualquier grifo

161214

- Con inversor integrado en la barra de ducha.
- Rociador de ducha orientable de acero inoxidable: Ø 250 mm.
- Soporte deslizante y orientable para ducha de mano.
- Ducha de mano anticalcárea: Ø 100 mm. (5 tipos de chorro).
- Flexo satinado.

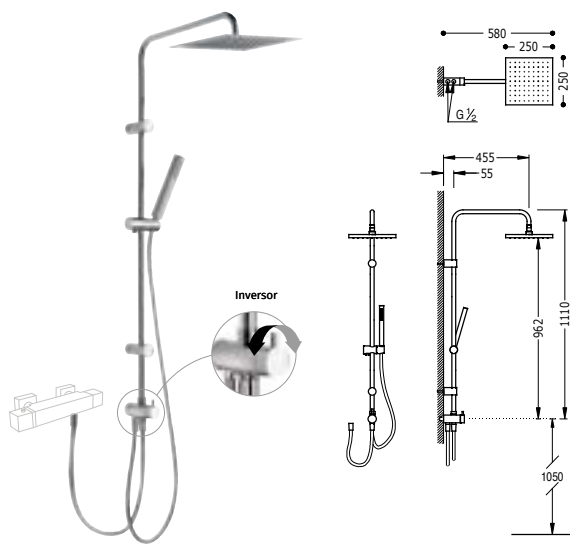

Conjunto de ducha adaptable a cualquier grifo

06163506

- Con inversor integrado en la barra de ducha.
- Rociador de ducha orientable de acero inoxidable: 250x250 mm.
- Soporte deslizante y orientable para ducha de mano.
- Ducha de mano anticalcárea de latón.
- Flexo satinado.

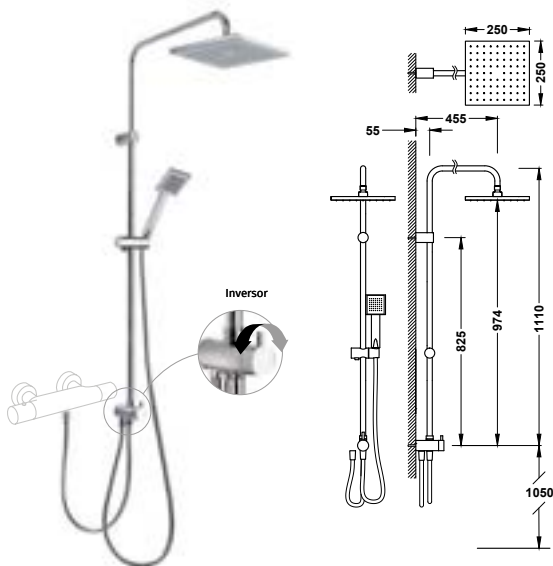
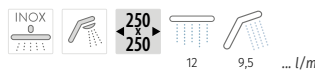

Conjunto de ducha adaptable a cualquier grifo

20047501

- Con inversor integrado en la barra de ducha.
- Rociador de ducha orientable: 250x250 mm.
- Soporte deslizante y orientable para ducha de mano.
- Ducha de mano anticalcárea: 80x80 mm.
- Flexo metálico reforzado.



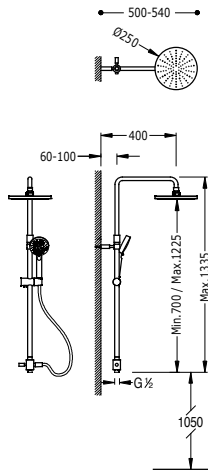

Conjunto de barra de ducha sin grifo con toma de agua y rociador

161213

- Con inversor integrado en la barra de ducha.
- Barra de ducha telescópica.
- Rociador de ducha orientable de acero inoxidable: Ø 250 mm.
- Soporte deslizante y orientable para ducha de mano.
- Ducha de mano anticalcárea: Ø 100 mm. (5 tipos de chorro).
- Flexo satinado.

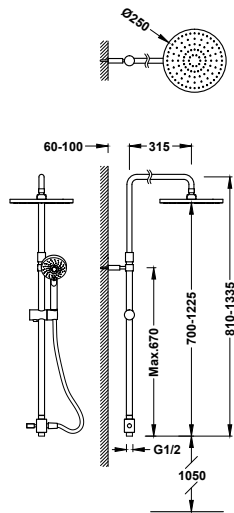

Conjunto de barra de ducha sin grifo con toma de agua y rociador

06163509

- Con inversor integrado en la barra de ducha.
- Barra de ducha telescópica.
- Rociador de ducha orientable de acero inoxidable: Ø 250 mm.
- Soporte deslizante y orientable para ducha de mano.
- Ducha de mano anticalcárea: Ø 100 mm.
- Flexo satinado.

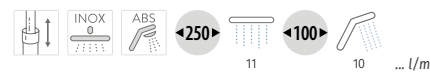

SOPORTES ORIENTABLES

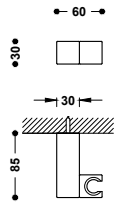

Soporte orientable para ducha de mano
Material: Latón.

- 107839
- 107839NM
- 107839BM
- 50783903
- 107839OR
- 107839OM

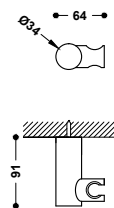

Soporte orientable para ducha de mano
Material: Latón.

- 161839
- 06183901NM
- 06183901BM
- 06183901AC
- 06183901KM
- 06183901KMB
- 06183901OR
- 06183901OM
- 06183901OPM

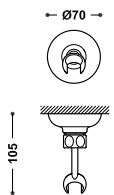

Soporte orientable para ducha de mano
Material: Latón.

- 29963910
- 29963910AC
- 29963910OR
- 29963910LV
- 29963910LM

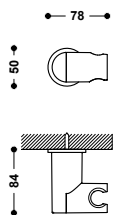

Soporte orientable para ducha de mano

- 29963901

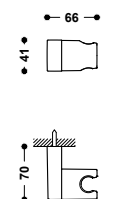

Soporte orientable para ducha de mano

- 29963928



Soporte articulado con 3 posiciones para ducha de mano

134215023



Soporte fijo para ducha de mano

9134841



Soporte fijo con 2 posiciones para ducha de mano

9134848



SOPORTES CON TOMA A PARED

Soporte fijo con toma de agua para ducha de mano y flexo
Válvula antirretorno. Material: Latón.

20718201

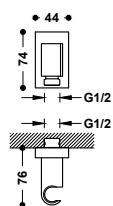

- 20718201NM
- 20718201BM
- 20718201AC
- 20718201OR
- 20718201OM

Soporte fijo con toma de agua para ducha de mano y flexo
Válvula antirretorno.

20018201

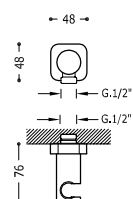

- 20018201NM
- 20018201BM
- 20018201AC
- 20018201OR
- 20018201OM



Soporte fijo con toma de agua para ducha de mano y flexo
Válvula antirretorno.

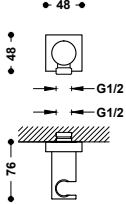

- 21118201
- 21118201NM
- 21118201BM
- 21118201AC
- 21118201KM
- 21118201KMB
- 21118201OR
- 21118201OM
- 21118201OP
- 21118201OPM



Soporte fijo con toma de agua para ducha de mano y flexo
Válvula antirretorno.

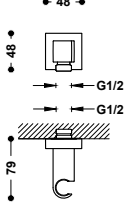

- 20218201
- 20218201NM
- 20218201BM
- 20218201AC
- 20218201OR
- 20218201OM





Soporte fijo con toma de agua para ducha de mano y flexo
Válvula antirretorno.

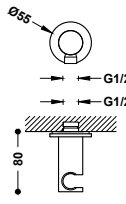

- 21518201



Soporte fijo con toma de agua para ducha de mano y flexo
Válvula antirretorno.

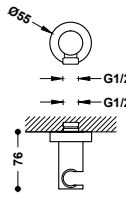

- 26118201
- 26118201NM
- 26118201BM
- 26118201AC
- 26118201KM
- 26118201KMB
- 26118201OR
- 26118201OM
- 26118201OP
- 26118201OPM



Soporte fijo con toma de agua para ducha de mano y flexo
Válvula antirretorno.

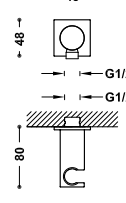

- 21618201

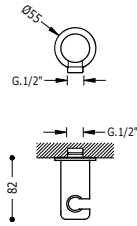

Soporte fijo con toma de agua para ducha de mano y flexo
Válvula antirretorno.

02418201

CODO ADAPTADOR A PARED

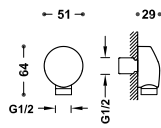

Codo con toma a pared para flexo
Con toma de agua a pared G1/2.

134757

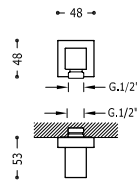

Codo con toma a pared para flexo
Con toma de agua a pared G1/2.

00618301

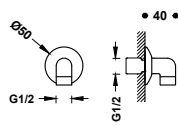

Codo con toma a pared para flexo
Con toma de agua a pared G1/2.

134873

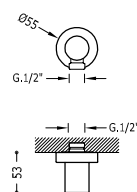

Codo con toma a pared para flexo
Con toma de agua a pared G1/2.

20518301

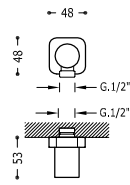

Codo con toma a pared para flexo
Con toma de agua a pared G1/2.

20018301

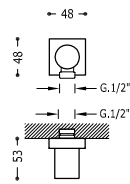

Codo con toma a pared para flexo
Con toma de agua a pared G1/2.

06118301

JETS

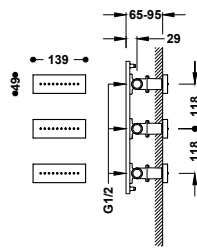

3 jets empotrados de hidromasaje

Con perfil de instalación incluido. Material: Latón. Medida: 139x49 mm.

29951504

- 29951504NM
- 29951504BM
- 29951504AC
- 29951504OR
- 29951504OM

7,9 ... l/m

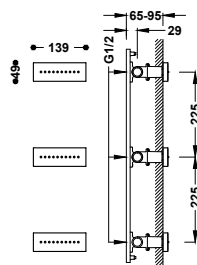

3 jets empotrados de hidromasaje

Con perfil de instalación incluido. Material: Latón. Medida: 139x49 mm.

29951505

- 29951505NM
- 29951505BM
- 29951505AC
- 29951505OR
- 29951505OM

7,9 ... l/m

3 jets empotrados giratorios de hidromasaje
 Con perfil de instalación incluido. Medida: 80x80 mm.

29951506

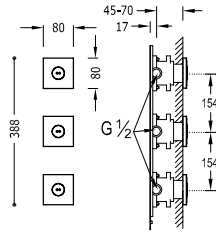

3 jets empotrados giratorios de hidromasaje
 Con perfil de instalación incluido. Medida: 80x80 mm.

29951507

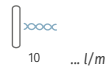
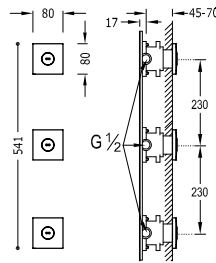

3 jets empotrados de hidromasaje
 Con perfil de instalación incluido. Medida: 80x80 mm.

13451501

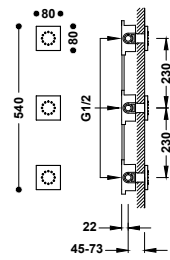

- 13451501NM
- 13451501BM
- 13451501AC
- 13451501KM
- 13451501KMB
- 13451501OR
- 13451501OM
- 13451501OP
- 13451501PM

Jet empotrado de hidromasaje
 Con rótula orientable. 1 tipo de chorro. Incluye un sistema antical, válvula antiretorno y limitador de caudal: 5 l/min.

9161515

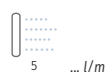
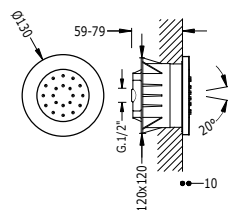

Jet empotrado de hidromasaje

9107515

Con rótula orientable. 1 tipo de chorro. Incluye un sistema antical, válvula antiretorno y limitador de caudal: 5 l/min.

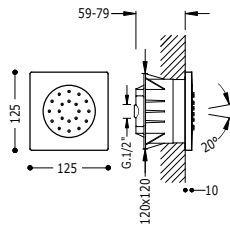

Jet de hidromasaje

9134515

Con rótula orientable. 1 tipo de chorro. Incluye un sistema antical, válvula antiretorno y limitador de caudal: 5 l/min. Material: Latón.

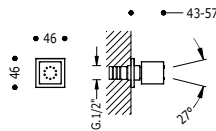

Jet de hidromasaje

29951501

Con rótula orientable. 1 tipo de chorro. Incluye un sistema antical, válvula antiretorno y limitador de caudal: 5 l/min. Material: Latón.

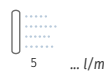
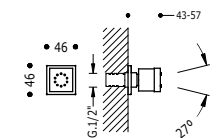

Jet de hidromasaje

29951503

Con rótula orientable. 1 tipo de chorro. Incluye un sistema antical, válvula antiretorno y limitador de caudal: 5 l/min. Material: Latón.

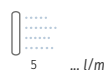
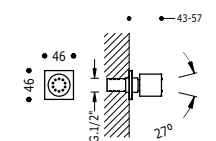

Jet de hidromasaje

Con rótula orientable. 1 tipo de chorro. Incluye un sistema anticaul, válvula antiretorno y limitador de caudal: 5 l/min. Material: Latón.

■ 29951502

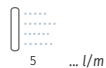
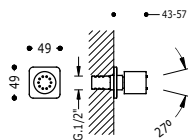

Jet de hidromasaje

Con rótula orientable. 1 tipo de chorro. Incluye un sistema anticaul, válvula antiretorno y limitador de caudal: 5 l/min. Material: Latón.

■ 9134415

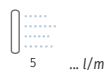
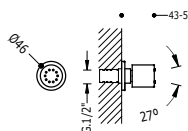

Jet de hidromasaje

Con rótula orientable. 2 tipos de chorro. Caudal: 6 l/min y 4.5 l/min.

■ 9134915

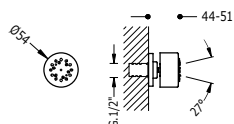

Jet de hidromasaje

Con rótula orientable. 1 tipo de chorro. Caudal: 4 l/min.

■ 9134615

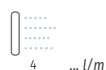
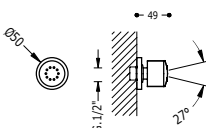



ACCESORIOS DE BAÑO









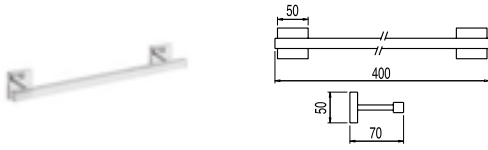



Cuadrado	414
Redondo	415
Clásico	416

CUADRADO

Toallero
400 mm.









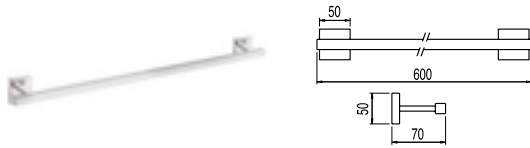



-  10723601
-  10723601NM
-  10723601BM
-  10723601AC
-  10723601KM
-  10723601KMB
-  10723601OR
-  10723601OM
-  10723601OP
-  10723601OPM

N
N
N
N

Toallero
600 mm.









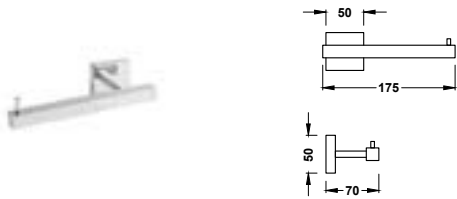



-  10723603
-  10723603NM
-  10723603BM
-  10723603AC
-  10723603KM
-  10723603KMB
-  10723603OR
-  10723603OM
-  10723603OP
-  10723603OPM

N
N
N
N

Portarrollos sin tapa









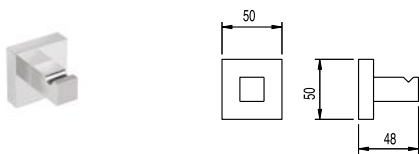



-  10723606
-  10723606NM
-  10723606BM
-  10723606AC
-  10723606KM
-  10723606KMB
-  10723606OR
-  10723606OM
-  10723606OP
-  10723606OPM

N
N
N
N

Percha











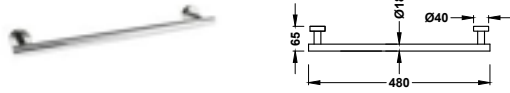

-  10723620
-  10723620NM
-  10723620BM
-  10723620AC
-  10723620KM
-  10723620KMB
-  10723620OR
-  10723620OM
-  10723620OP
-  10723620OPM

N
N
N
N

REDONDO

Toallero
480 mm.













-  16123601
-  16123601NM
-  16123601BM
-  16123601AC
-  16123601KM
-  16123601KMB
-  16123601OR
-  16123601OM
-  16123601OP
-  16123601OPM

- 
- 
- 
- 

Toallero
580 mm.













-  16123602
-  16123602NM
-  16123602BM
-  16123602AC
-  16123602KM
-  16123602KMB
-  16123602OR
-  16123602OM
-  16123602OP
-  16123602OPM

- 
- 
- 
- 

Portarrollos sin tapa



-  16123606
-  16123606NM
-  16123606BM
-  16123606AC
-  16123606KM
-  16123606KMB
-  16123606OR
-  16123606OM
-  16123606OP
-  16123606OPM

- 
- 
- 
- 

Asidero para bañera
306 mm.

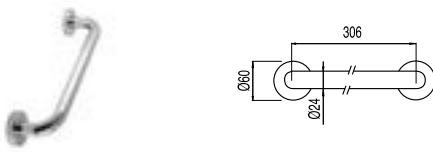







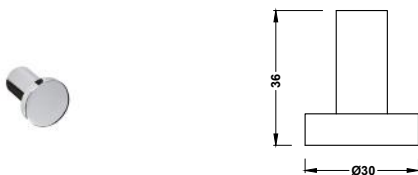



-  134184
-  134184NM
-  134184BM
-  134184AC
-  134184KM
-  134184KMB
-  134184OR
-  134184OM
-  134184OP
-  134184OPM

- 
- 
- 
- 
- 
- 
- 
- 
- 

Percha



-  16123620
-  16123620NM
-  16123620BM
-  16123620AC
-  16123620KM
-  16123620KMB
-  16123620OR
-  16123620OM
-  16123620OP
-  16123620OPM

- 
- 
- 
- 

CLÁSICO

Toallero
400 mm.

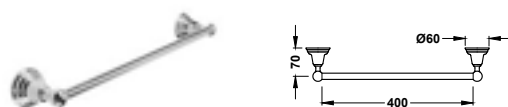

- 12423601
- 12423601AC
- 12423601OR
- 12423601LV
- 12423601LM

Toallero
600 mm.

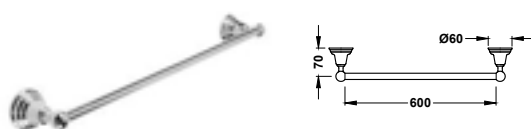

- 12423603
- 12423603AC
- 12423603OR
- 12423603LV
- 12423603LM

Toallero de anilla cuadrada

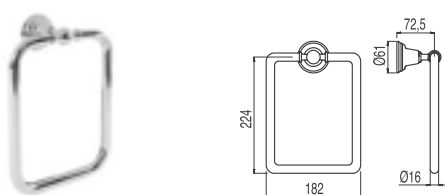

- 12463609
- 02463609AC
- 02463609OR
- 5246360951
- 02463609LM

Portarrollos sin tapa



- 12423606
- 12423606AC
- 12423606OR
- 12423606LV
- 12423606LM

Percha



- 12423607
- 12423607AC
- 12423607OR
- 12423607LV
- 12423607LM



TECNOLOGÍA ELECTRÓNICA





Shower Technology	420
Lavabos	429
Dispensadores de jabón	435
Sensores WC	436
Cocina electrónica	437

COMPLETA TU DUCHA ELECTRÓNICA



+

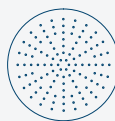

2 vías (492 862 99 - 492 882 99)

3 vías (492 863 98 - 492 883 98)

3 vías (492 863 99 - 492 883 99)

4 vías (492 864 99 - 492 884 99)

Se recomienda la instalación de complementos de ducha de Tres para garantizar su buen funcionamiento.

PANTALLA DE CONTROL

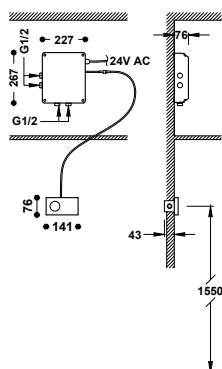

Control termostático electrónico empotrado de 2 vías Shower Technology Blue Edition

49286299

49288299

- Control electrónico incluido con juntas antihumedad Schlüter.
- Centralita termostática electrónica incluida (2 vías).
- Temperatura mínima disponible inferior a los 25°C.
- Sistema puesta a punto: Preparación de la temperatura deseada.
- Con programas antilegionela.

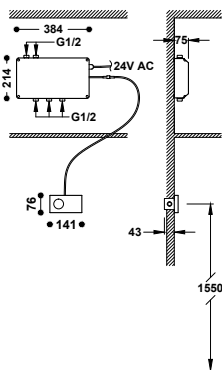

Control termostático electrónico empotrado de 3 vías Shower Technology Blue Edition

49286398

49288398

- Control electrónico incluido con juntas antihumedad Schlüter.
- Centralita termostática electrónica incluida (3 vías).
- Temperatura mínima disponible inferior a los 25°C.
- Sistema puesta a punto: Preparación de la temperatura deseada.
- Con programas antilegionela.



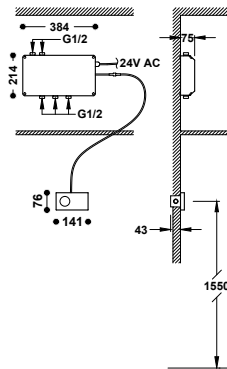

**Control termostático electrónico empotrado de 3 vías
Shower Technology Blue Edition**

- Control electrónico incluido con juntas antihumedad Schlüter.
- Centralita termostática electrónica incluida (3 vías).
- Temperatura mínima disponible inferior a los 25°C.
- Sistema puesta a punto: Preparación de la temperatura deseada.
- Con programas antilegionela.

- 49286399
- 49288399

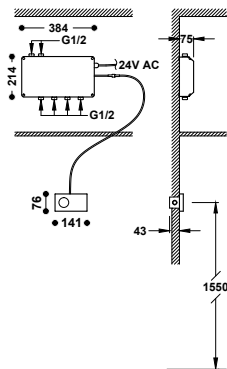

**Control termostático electrónico empotrado de 4 vías
Shower Technology Blue Edition**

- Control electrónico incluido con juntas antihumedad Schlüter.
- Centralita termostática electrónica incluida (4 vías).
- Temperatura mínima disponible inferior a los 25°C.
- Sistema puesta a punto: Preparación de la temperatura deseada.
- Con programas antilegionela.

- 49286499
- 49288499

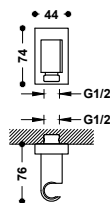

Soporte fijo con toma de agua para ducha de mano y flexo
Con toma de agua a pared. Válvula antirretorno. Material: Latón.

- 20718201
- 20718201NM
- 20718201BM
- 20718201AC
- 20718201OR
- 20718201OM
- 20718201OPM



KITS DE 2 VÍAS

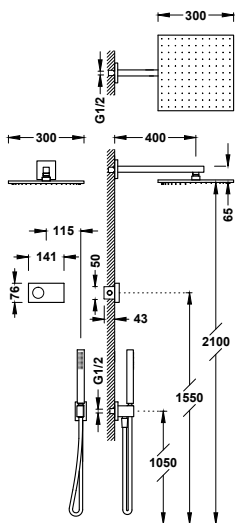

**Kit de grifo termostático electrónico empotrado de 2 vías
Shower Technology Blue Edition para ducha**

- Control electrónico incluido con juntas antihumedad Schlüter.
- Centralita termostática electrónica incluida (2 vías).
- Brazo a pared de ducha orientable y de acero inoxidable: 300x300 mm.
- Soporte para ducha de mano con toma de agua a pared.
- Ducha de mano anticalcárea de latón.
- Flexo satinado.

- 09286563
- 09286563OM
- 09286563OPM
- 09288563NM

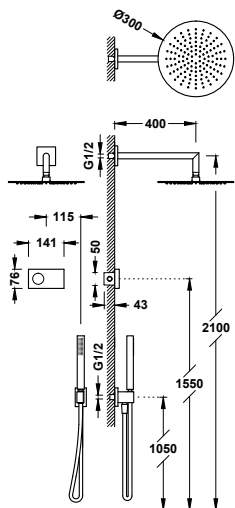
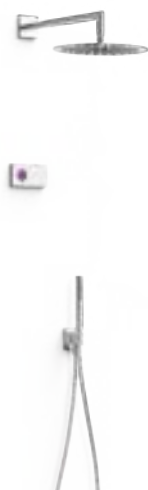

**Kit de grifo termostático electrónico empotrado de 2 vías
Shower Technology Blue Edition para ducha**

- Control electrónico incluido con juntas antihumedad Schlüter.
- Centralita termostática electrónica incluida (2 vías).
- Brazo a pared con rociador de ducha orientable y de acero inoxidable: Ø 300 mm.
- Soporte para ducha de mano con toma de agua a pared.
- Ducha de mano anticalcárea de latón.
- Flexo satinado.

- 09286558
- 09286558OM
- 09286558OPM
- 09288558NM

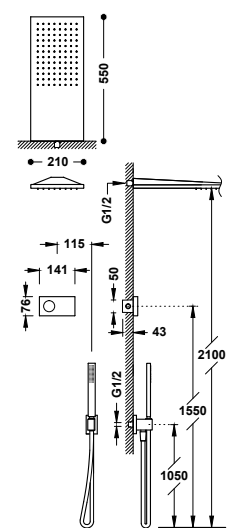
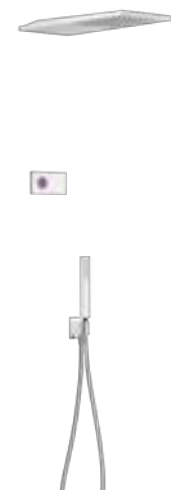

**Kit de grifo termostático electrónico empotrado de 2 vías
Shower Technology Blue Edition para ducha**

- Control electrónico incluido con juntas antihumedad Schlüter.
- Centralita termostática electrónica incluida de 2 vías.
- Rociador de ducha a pared de acero inoxidable: 210x550 mm.
- Soporte para ducha de mano con toma de agua a pared.
- Ducha de mano anticalcárea de latón.
- Flexo satinado.

- 09286551
- 09286551OM
- 09286551OPM
- 09288551NM



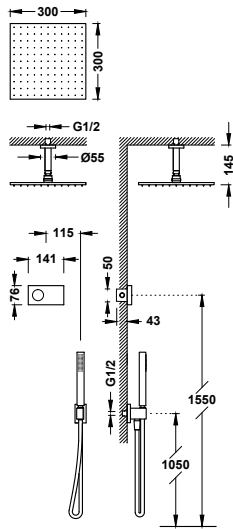

**Kit de grifo termostático electrónico empotrado de 2 vías
Shower Technology Blue Edition para ducha**

- Control electrónico incluido con juntas antihumedad Schlüter.
- Centralita termostática electrónica incluida (2 vías).
- Brazo a techo con rociador de ducha orientable y de acero inoxidable: 300x300 mm.
- Soporte para ducha de mano con toma de agua a pared.
- Ducha de mano anticalcárea de latón.
- Flexo satinado.

- 09286564
- 09286564OM
- 09286564OPM



- 09288564NM

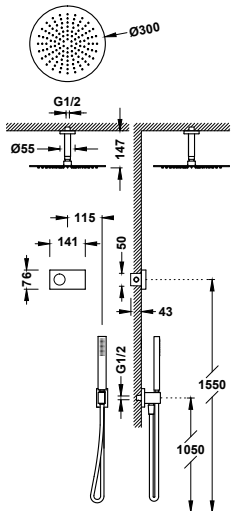

**Kit de grifo termostático electrónico empotrado de 2 vías
Shower Technology Blue Edition para ducha**

- Control electrónico incluido con juntas antihumedad Schlüter.
- Centralita termostática electrónica incluida (2 vías).
- Brazo a techo con rociador de ducha orientable y de acero inoxidable: Ø 300 mm.
- Soporte para ducha de mano con toma de agua a pared.
- Ducha de mano anticalcárea de latón.
- Flexo satinado.

- 09286567
- 09286567OM
- 09286567OPM



- 09288567NM

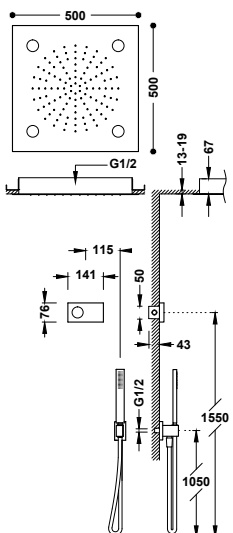

Kit de grifo termostático electrónico empotrado de 2 vías Shower Technology Blue Edition con Cromoterapia para ducha

- Control electrónico incluido con juntas antihumedad Schlüter.
- Centralita termostática electrónica incluida (2 vías).
- Rociador de ducha empotrado a techo con Cromoterapia de acero inoxidable: 500x500 mm
- Soporte para ducha de mano con toma de agua a pared.
- Ducha de mano anticalcárea de latón.
- Flexo satinado.

- 09286562



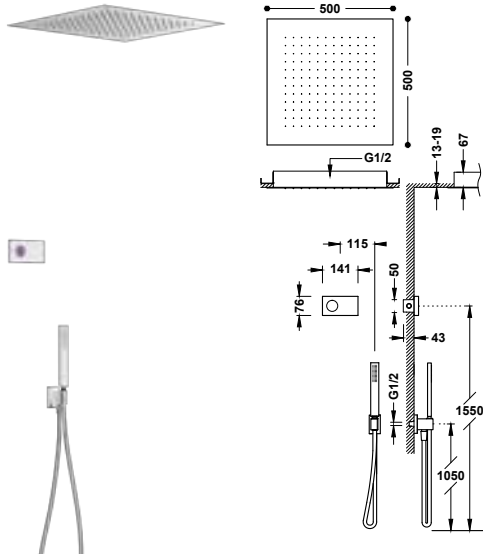

**Kit de grifo termostático electrónico empotrado de 2 vías
Shower Technology Blue Edition para ducha**

- Control electrónico incluido con juntas antihumedad Schlüter.
- Centralita termostática electrónica incluida (2 vías).
- Rociador de ducha empotrado a techo de acero inoxidable: 500x500 mm.
- Soporte para ducha de mano con toma de agua a pared.
- Ducha de mano anticalcárea de latón.
- Flexo satinado.

09286561



09288561NM

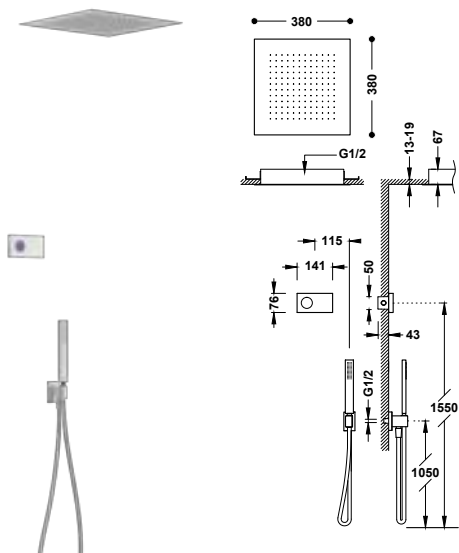

**Kit de grifo termostático electrónico empotrado de 2 vías
Shower Technology Blue Edition para ducha**

- Control electrónico incluido con juntas antihumedad Schlüter.
- Centralita termostática electrónica incluida (2 vías).
- Rociador de ducha empotrado a techo de acero inoxidable: 380x380 mm.
- Soporte para ducha de mano con toma de agua a pared.
- Ducha de mano anticalcárea de latón.
- Flexo satinado.

09286552



09288552NM

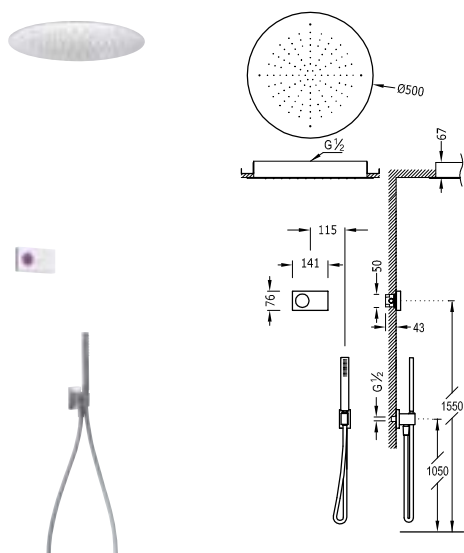

**Kit de grifo termostático electrónico empotrado de 2 vías
Shower Technology Blue Edition para ducha**

- Control electrónico incluido con juntas antihumedad Schlüter.
- Centralita termostática electrónica incluida (2 vías).
- Rociador de ducha empotrado a techo de acero inoxidable: Ø 500 mm.
- Soporte para ducha de mano con toma de agua a pared.
- Ducha de mano anticalcárea de latón.
- Flexo satinado.

09286557



09288557NM



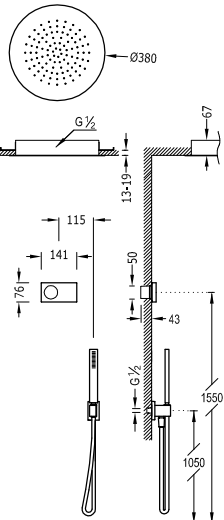

**Kit de grifo termostático electrónico empotrado de 2 vías
Shower Technology Blue Edition para ducha**

- Control electrónico incluido con juntas antihumedad Schlüter.
- Centralita termostática electrónica incluida (2 vías).
- Rociador de ducha empotrado a techo de acero inoxidable: Ø 380 mm.
- Soporte para ducha de mano con toma de agua a pared.
- Ducha de mano anticalcárea de latón.
- Flexo satinado.

09286555



09288555NM

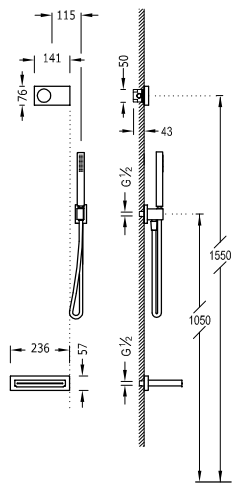

**Kit de grifo termostático electrónico empotrado de 2 vías
Shower Technology Blue Edition para bañera y ducha**

- Control electrónico incluido con juntas antihumedad Schlüter.
- Centralita termostática electrónica incluida (2 vías).
- Caño fijo de pared con salida en cascada.
- Soporte para ducha de mano con toma de agua a pared.
- Ducha de mano anticalcárea de latón.
- Flexo satinado.

09286556



09288556NM



KITS DE 3 VÍAS

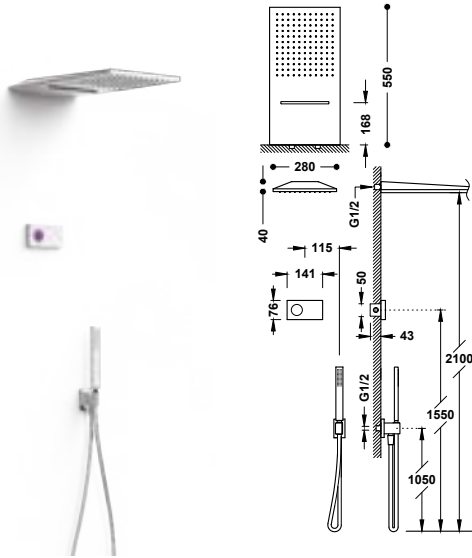

Kit de grifo termostático electrónico empotrado de 3 vías Shower Technology Blue Edition para ducha

- Control electrónico incluido con juntas antihumedad Schlüter.
- Centralita termostática electrónica incluida (3 vías).
- Rociador de ducha a pared de acero inoxidable con 2 tipos de chorro (lluvia/cascada). 280x550 mm. **IMPORTANTE:** Montar un desagüe de >50 l/min.
- Soporte para ducha de mano con toma de agua a pared.
- Ducha de mano anticalcárea de latón.
- Flexo satinado.

- 09286308
- 09286308OM
- 09286308OPM



- 09288308NM

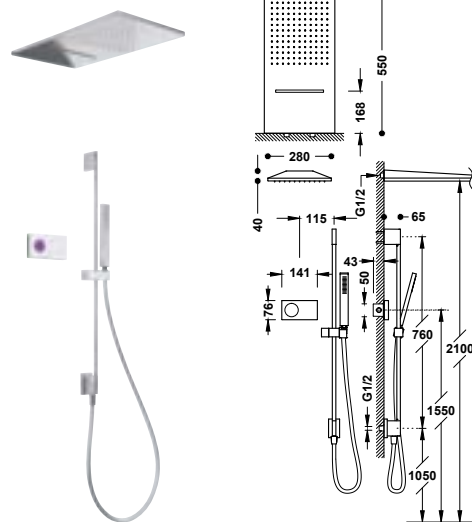

Kit de grifo termostático electrónico empotrado de 3 vías Shower Technology Blue Edition para ducha

- Control electrónico incluido con juntas antihumedad Schlüter.
- Centralita termostática electrónica incluida (3 vías).
- Rociador de ducha a pared de acero inoxidable con 2 tipos de chorro (lluvia/cascada). 280x550 mm. **IMPORTANTE:** Montar un desagüe de >50 l/min.
- Barra deslizante para ducha con toma de agua a pared.
- Ducha de mano anticalcárea de latón.
- Flexo satinado.

- 09286307

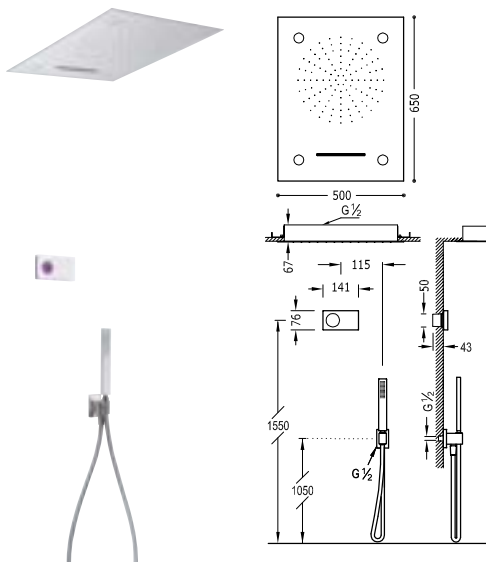
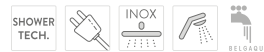

Kit de grifo termostático electrónico empotrado de 3 vías Shower Technology Blue Edition con Cromoterapia para ducha

- Control electrónico incluido con juntas antihumedad Schlüter.
- Centralita termostática electrónica incluida (3 vías).
- Rociador de ducha empotrado a techo con Cromoterapia de acero inoxidable con 2 tipos de chorro (lluvia/cascada). 500x650 mm. **IMPORTANTE:** Montar un desagüe de >50 l/min.
- Soporte para ducha de mano con toma de agua a pared.
- Ducha de mano anticalcárea de latón.
- Flexo satinado.

- 09286302



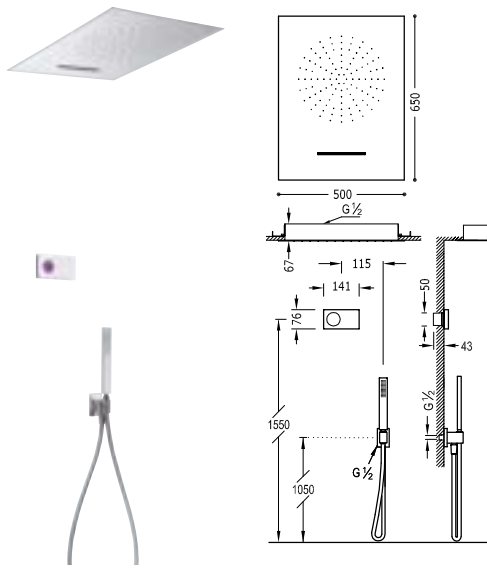

**Kit de grifo termostático electrónico empotrado de 3 vías
Shower Technology Blue Edition para ducha**

09286304



- Control electrónico incluido con juntas antihumedad Schlüter.
- Centralita termostática electrónica incluida (3 vías).
- Rociador de ducha empotrado a techo de acero inoxidable con 2 tipos de chorro (lluvia/cascada). 500x650 mm. IMPORTANTE: Montar un desagüe de >50 l/min.
- Soporte para ducha de mano con toma de agua a pared.
- Ducha de mano anticalcárea de latón.
- Flexo satinado.

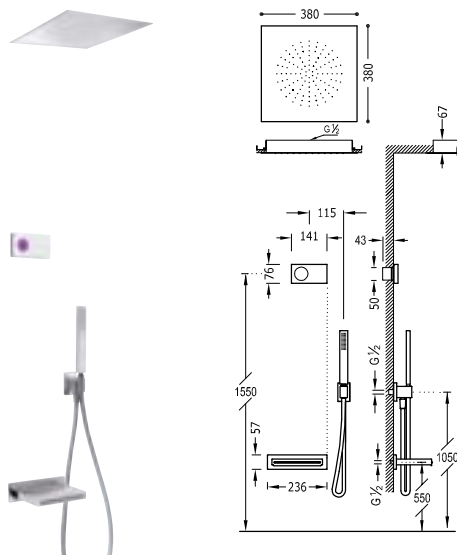

**Kit de grifo termostático electrónico empotrado de 3 vías
Shower Technology Blue Edition para bañera y ducha**

09286315



09288315NM



- Control electrónico incluido con juntas antihumedad Schlüter.
- Centralita termostática electrónica incluida (3 vías).
- Rociador de ducha empotrado a techo de acero inoxidable: 380x380 mm. IMPORTANTE: Montar un desagüe de >50 l/min.
- Caño fijo de pared con salida en cascada.
- Soporte para ducha de mano con toma de agua a pared.
- Ducha de mano anticalcárea de latón.
- Flexo satinado.



KITS DE 4 VÍAS

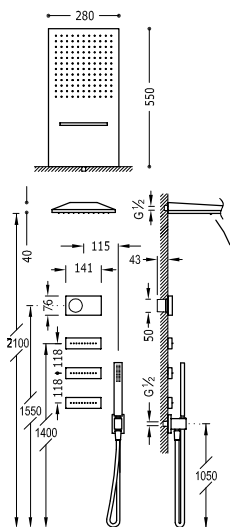

Kit de grifo termostático electrónico empotrado de 4 vías Shower Technology Blue Edition para ducha

- Control electrónico incluido con juntas antihumedad Schlüter.
- Centralita termostática electrónica incluida (4 vías).
- Rociador de ducha a pared de acero inoxidable con 2 tipos de chorro (lluvia/cascada). 280x550 mm. IMPORTANTE: Montar un desagüe de >50 l/min.
- 3 jets empotrados de hidromasaje de latón.
- Soporte para ducha de mano con toma de agua a pared.
- Ducha de mano anticalcárea de latón.
- Flexo satinado.

09286408



09288408NM

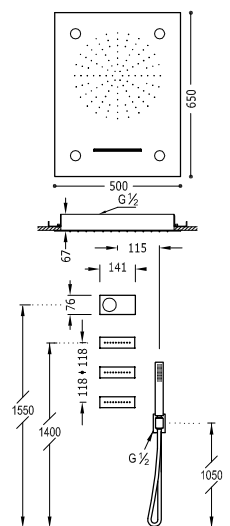

Kit de grifo termostático electrónico empotrado de 4 vías Shower Technology Blue Edition con Cromoterapia para ducha

- Control electrónico incluido con juntas antihumedad Schlüter.
- Centralita termostática electrónica incluida (4 vías).
- Rociador de ducha empotrado a techo con Cromoterapia de acero inoxidable con 2 tipos de chorro (lluvia/cascada). 500x650 mm. IMPORTANTE: Montar un desagüe de >50 l/min.
- 3 jets empotrados de hidromasaje de latón.
- Soporte para ducha de mano con toma de agua a pared.
- Ducha de mano anticalcárea de latón.
- Flexo satinado.

09286402

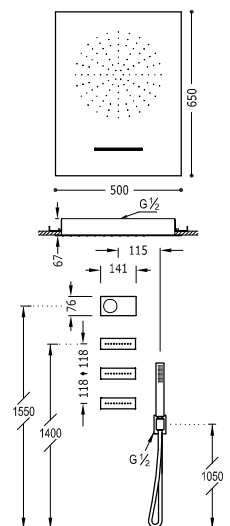

Kit de grifo termostático electrónico empotrado de 4 vías Shower Technology Blue Edition para ducha

- Control electrónico incluido con juntas antihumedad Schlüter.
- Centralita termostática electrónica incluida (4 vías).
- Rociador de ducha empotrado a techo de acero inoxidable con 2 tipos de chorro (lluvia/cascada). 500x650 mm. IMPORTANTE: Montar un desagüe de >50 l/min.
- 3 jets empotrados de hidromasaje de latón.
- Soporte para ducha de mano con toma de agua a pared.
- Ducha de mano anticalcárea de latón.
- Flexo satinado.

09286404



09288404NM



GRIFOS ELECTRÓNICOS DE 1 AGUA

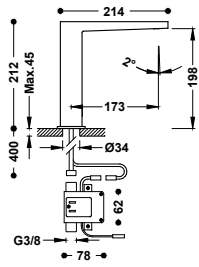

Grifo electrónico de 1 agua para lavabo
Accionado mediante sensor de infrarrojos.

- 20261310
- 20261310NM
- 20261310BM
- 20261310AC
- 20261310OR
- 20261310OM

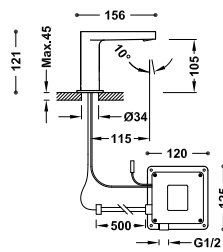

Grifo electrónico de 1 agua para lavabo
Accionado mediante sensor de infrarrojos. Caudal: 8,5 l/min.

20560301

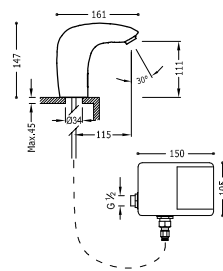

Grifo electrónico de 1 agua para lavabo
Accionado mediante sensor de infrarrojos.

19260603

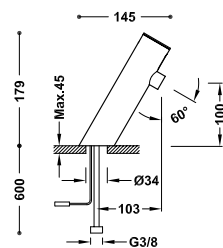

Grifo electrónico de 1 agua para lavabo
Accionado mediante sensor de infrarrojos. Caudal: 6 l/min.

39210302

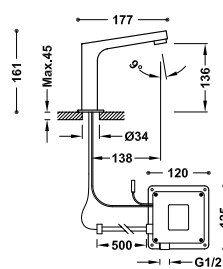

Grifo electrónico de 1 agua para lavabo
Accionado mediante sensor de infrarrojos.

39210307



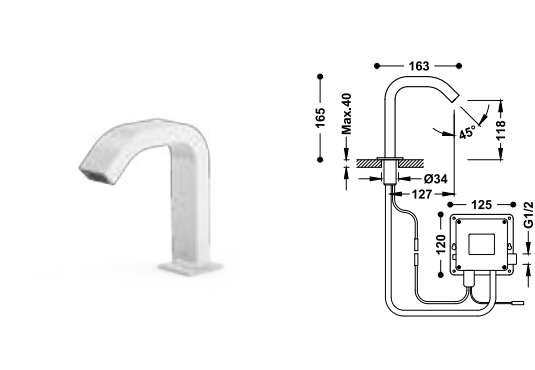

Grifo electrónico de 1 agua para lavabo
 Accionado mediante sensor de infrarrojos.

39210303

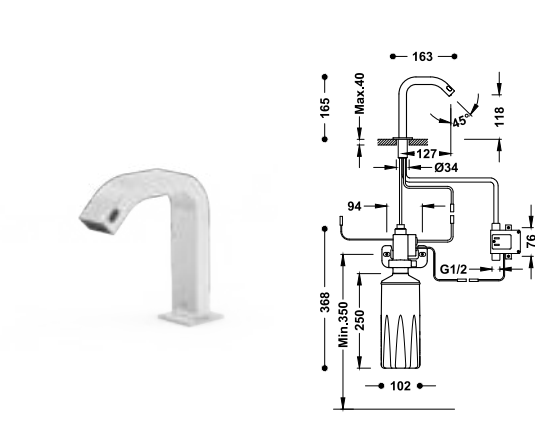

Grifo electrónico de 1 agua con dispensador de jabón automático para lavabo

Accionado mediante sensor de infrarrojos. Capacidad del depósito de jabón: 1600 ml.

39210304

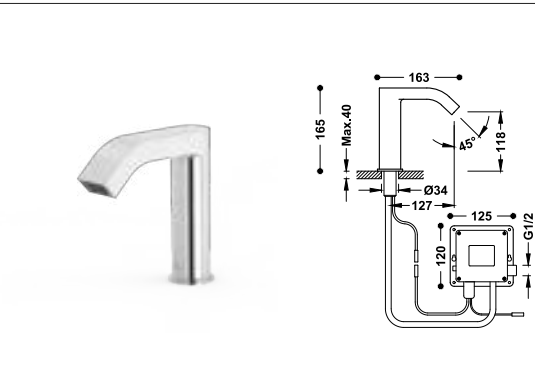

Grifo electrónico de 1 agua para lavabo
 Accionado mediante sensor de infrarrojos.

39210305

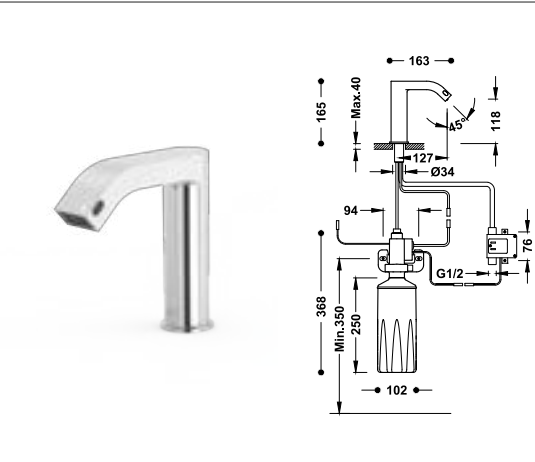

Grifo electrónico de 1 agua con dispensador de jabón automático para lavabo

Accionado mediante sensor de infrarrojos. Capacidad del depósito de jabón: 1600 ml.

39210306



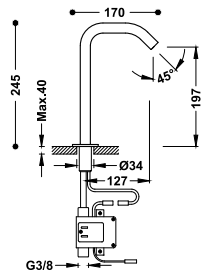

Grifo electrónico de 1 agua para lavabo
Accionado mediante sensor de infrarrojos.

39210319

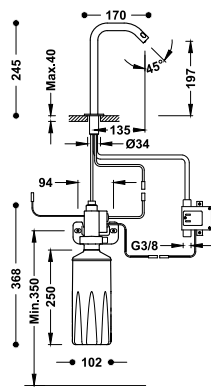

Grifo electrónico de 1 agua con dispensador de jabón automático para lavabo

Accionado mediante sensor de infrarrojos. Capacidad del depósito de jabón: 1600 ml.

39210320

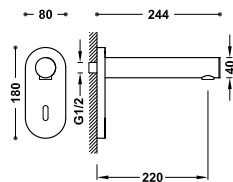

Grifo electrónico mural de 1 agua para lavabo

Accionado mediante sensor de infrarrojos. La caja de la batería está localizada dentro del mismo caño. Conexión roscada macho de G1/2.

39210308



GRIFO ELECTRÓNICO MURAL DE 1 AGUA PARA LAVABO

39210308

La caja de la batería está localizada dentro del mismo caño.
Sistema patentado.



4 x
AAA / LR06
Baterías NO incluidas
Larga duración: 8 años

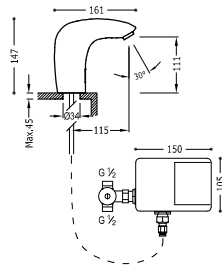

Grifo electrónico con sistema premezclador para lavabo

Accionado mediante sensor de infrarrojos. Incluye una válvula mezcladora de 2 aguas con tubos flexibles (ref.: 19250730).

19290603

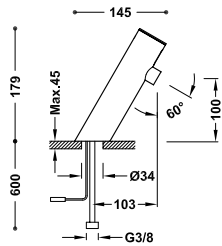

Grifo electrónico con sistema premezclador para lavabo

Accionado mediante sensor de infrarrojos. Con selector de temperatura a través de una palanca lateral. Caudal: 6 l/min.

39210301

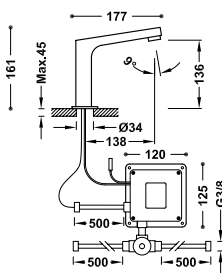

Grifo electrónico con sistema premezclador para lavabo

Accionado mediante sensor de infrarrojos. Incluye una válvula mezcladora de 2 aguas con tubos flexibles (ref.: 19250730).

39210309

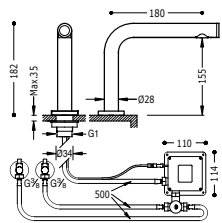

Grifo electrónico con sistema premezclador para lavabo

Sistema sensible al tacto TOUCH-TRES. Incluye una válvula mezcladora de 2 aguas con tubos flexibles (ref.: 19250730).

06144801

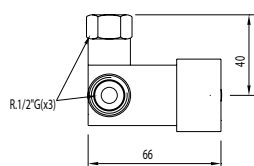

Válvula mezcladora de 2 aguas para grifo temporizado o electrónico

Apto para hacer llegar agua premezclada a un grifo de 1 agua de lavabo y cocina.

19250730

KITS DE GRIFO ELECTRÓNICO

Kit de grifo electrónico de 1 agua para lavabo

39210391

- 39210302 - Grifo electrónico de 1 agua para lavabo.
- 134215028 - Válvula de desagüe siempre abierto para lavabo.
- 134215024 - Sifón curvo articulado para lavabo.
- 134215007 x 1 - Llave de escuadra con filtro.

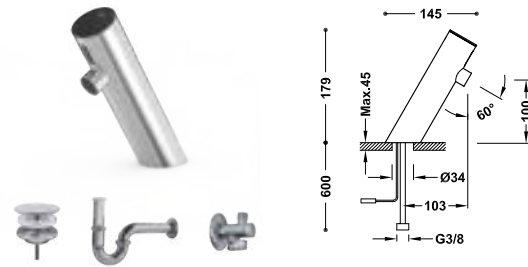

Kit de grifo electrónico con sistema premezclador para lavabo

39210390

- 39210301 - Grifo electrónico con sistema premezclador para lavabo.
- 134215028 - Válvula de desagüe siempre abierto para lavabo.
- 134215024 - Sifón curvo articulado para lavabo.
- 134215007 x 2 - Llave de escuadra con filtro.

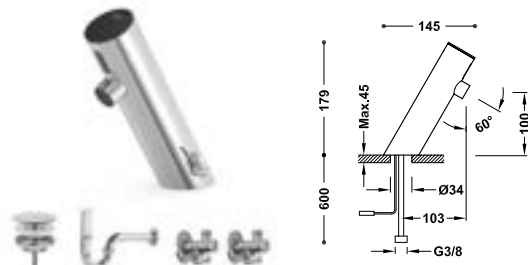

Kit de grifo electrónico de 1 agua para lavabo

39210397

- 39210307 - Grifo electrónico de 1 agua para lavabo.
- 134215028 - Válvula de desagüe siempre abierto para lavabo.
- 134215024 - Sifón curvo articulado para lavabo.
- 134215007 x 1 - Llave de escuadra con filtro.

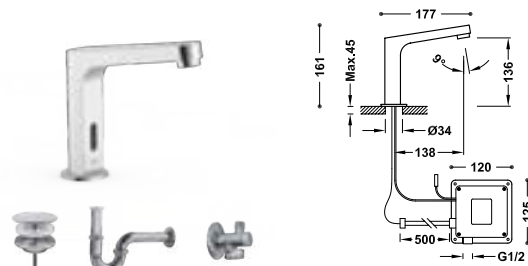

Kit de grifo electrónico con sistema premezclador para lavabo

39210399

- 39210309 - Grifo electrónico con sistema premezclador para lavabo.
- 134215028 - Válvula de desagüe siempre abierto para lavabo.
- 134215024 - Sifón curvo articulado para lavabo.
- 134215007 x 2 - Llave de escuadra con filtro.

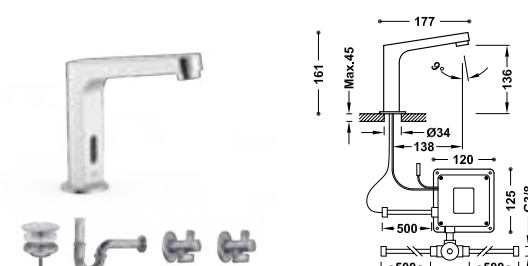

DISPENSADORES DE JABÓN

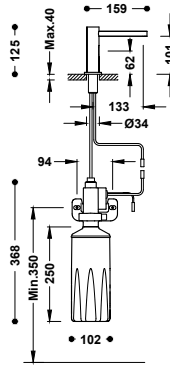

Dispensador electrónico de jabón para lavabo y cocina
 Accionado mediante sensor de infrarrojos. Capacidad del depósito de jabón: 1.600 ml.

39274101

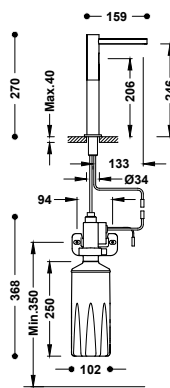

Dispensador electrónico alto de jabón para lavabo y cocina
 Accionado mediante sensor de infrarrojos. Capacidad del depósito de jabón: 1.600 ml.

39274102

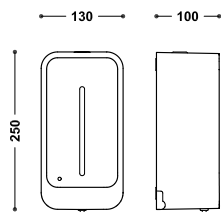

Dispensador electrónico de gel o jabón
 Accionado mediante sensor de infrarrojos. Capacidad del depósito de jabón: 1.000 ml.

01240801

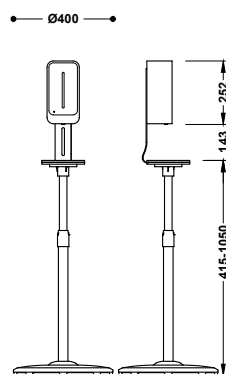

Soporte a suelo con estante y dispensador electrónico de gel o jabón

01240850

Ajustable en altura para el hogar, negocio, escuela, hotel. Capacidad del depósito de jabón: 1.000 ml.



SENSORES WC

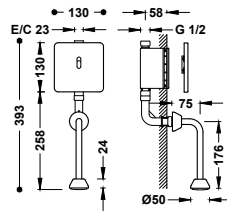

Grifo electrónico empotrado con sensor para urinario
 Accionado mediante sensor de infrarrojos. Con un tubo adaptable a urinario. Material: Acero inoxidable.

01220702

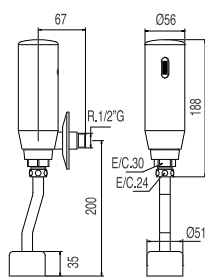

Grifo de descarga electrónico mural de 1 agua para urinario
 Accionado mediante sensor de infrarrojos. Con dos tubos adaptables a urinario.

112206

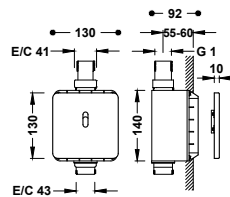

Grifo electrónico empotrado con sensor para váter
 Accionado mediante sensor de infrarrojos. Material: Acero inoxidable.

01221701



SECADOR DE MANOS

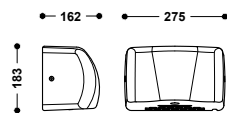

Secador de manos automático por aire caliente
 Accionado mediante sensor de infrarrojos.

39274201
 39274201AC
 39274201BL



COCINA ELECTRÓNICA

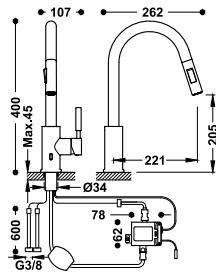

Grifo electrónico con caño extraíble y 2 tipos de chorro para cocina

09244501AC

Accionado mediante sensor de infrarrojos. Con regulador de caudal y temperatura a través de una maneta lateral. Material: Acero inoxidable.

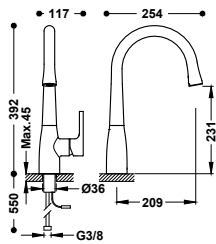

Grifo electrónico para cocina

09244601

Accionado mediante sensor de infrarrojos situado detrás de la salida del agua. Con regulador de caudal y temperatura a través de una maneta lateral.

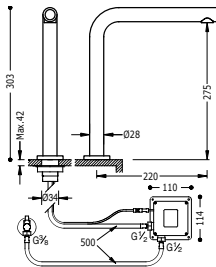

Grifo electrónico de 1 agua para cocina

161445

Sistema sensible al tacto TOUCH-TRES. Con latiguillos de alimentación flexible G3/8.

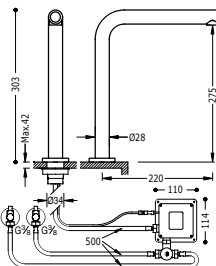

Grifo electrónico con sistema premezclador para cocina

161446

Sistema sensible al tacto TOUCH-TRES. Incluye una válvula mezcladora de 2 aguas con tubos flexibles (ref.: 19250730). Con latiguillos de alimentación flexible G3/8.



ESPACIO DE COCINA



































Monomandos	444
A muro	454
Con caño flexible	457
Para tratamiento de agua	458
Con caño extraíble	460
Con caño abatible	462
Bimandos	462
Industriales	466
Electrónicos	468
Grifos para varios usos	469



Referencia	Página	Acabados disponibles	Tecnología	Certificados	Altura (mm)
MONOMANDOS					
	106486	444			300
	106440	444			270
	130496	444			305
	130497	444			367
	130498	444			367
	06248801	445			296
	20548601	445			300
	20044001	445			300
	162435	445			310
	162541	446			350
	162441	446			376
	130336	446			286

Referencia	Página	Acabados disponibles	Tecnología	Certificados	Altura (mm)
	162436	446			304
	181436	445			304
	20044002	447			418
	06254201 20544001	447 446			418
	162540	447			450
	181540	447			417
	162440	448			426
	162442	447			350
	181341 183341	448			351
	24234101	448			293
	24244101	448			268
	06944701 172447 17044702	450 449			352

Referencia	Página	Acabados disponibles	Tecnología	Certificados	Altura (mm)
 21644010	450	<input type="checkbox"/>			378
 21644020	450	<input type="checkbox"/>	 	 	378
 21644710	449	<input type="checkbox"/>			338
 21644720	449	<input type="checkbox"/>	 		338
 06944001	449	<input type="checkbox"/>	 		330
 169440 117440	450	<input type="checkbox"/>			380
 17044102	451	<input type="checkbox"/>			260
 139441	451	<input type="checkbox"/>		 	260
 21544101	451	<input type="checkbox"/>			264
 172440 17044002	451 452	<input type="checkbox"/>			233
 07044802	452	<input type="checkbox"/>			261
 08333301	451	<input type="checkbox"/>			300

Referencia	Página	Acabados disponibles	Tecnología	Certificados	Altura (mm)
 117333	453	<input type="checkbox"/>		 	180
 17033302	452	<input type="checkbox"/>		 	178
 130337	453	<input type="checkbox"/>			180
 21533301 172333	452	<input type="checkbox"/>			180

A MURO



 172317 172318	454	<input type="checkbox"/>			283* 273*
 17032002 17041802 07032003	454	<input type="checkbox"/>			273* 233* 203*
 21632010 21632020 21632030	455	<input type="checkbox"/>			168* 228* 268*
 172418 172218	455 456	<input type="checkbox"/>			272*
 17021802 17031802	456	<input type="checkbox"/>			272*
 21642010	456	<input type="checkbox"/>			264*
 172420	455	<input type="checkbox"/>			293*
 17033202	456	<input type="checkbox"/>			293*



ESPACIO DE COCINA

Referencia	Página	Acabados disponibles	Tecnología	Certificados	Altura (mm)
------------	--------	----------------------	------------	--------------	-------------

CAÑO FLEXIBLE

	00648701	457			455
	20548702	457			455
	03048701 06248702	457			455

CAÑO EXTRAÍBLE

	106437	460		 	300
	162438 181438	460			315
	162437	460			293
	181437	460			293
	114444	461			370
	06944401 03944401 03044401	461			300
	03043801	462			413
	03043401	461			294

Referencia	Página	Acabados disponibles	Tecnología	Certificados	Altura (mm)
------------	--------	----------------------	------------	--------------	-------------

INDUSTRIAL

	130495	466			760
	130484	466			294
	03048501	467			548
	03049301	467			564
	130481	466			1200

ELECTRÓNICA

	09244501AC	468		 	400
	09244601	468		 	392
	161445 161446	468		 	303

ABATIBLE

	130335	462		  	256
	24233401	462			293

Referencia	Página	Acabados disponibles	Tecnología	Certificados	Altura (mm)
------------	--------	----------------------	------------	--------------	-------------



PARA TRATAMIENTO DEL AGUA

	162453	459	<input type="checkbox"/>		304
	162456	459	<input type="checkbox"/>		304
	03035501	459	<input type="checkbox"/>		375
	03045501	459	<input type="checkbox"/>		375



BIMANDO

	163333	462	<input type="checkbox"/>		427
	24234201	462	<input type="checkbox"/>	<input type="checkbox"/>	256
	24221501	463	<input type="checkbox"/>	<input type="checkbox"/>	284*
	24231001	463	<input type="checkbox"/>	<input type="checkbox"/>	283*
	123342	463	<input type="checkbox"/>		286
	123310 123210	463	<input type="checkbox"/>		270*
	123214 123215 123230	464	<input type="checkbox"/>		219* 269* 369*

Referencia	Página	Acabados disponibles	Tecnología	Certificados	Altura (mm)
------------	--------	----------------------	------------	--------------	-------------

	123314 123315 123330 123360	464 465	<input type="checkbox"/>		219* 269* 369* 429*
	123416	465	<input type="checkbox"/>		309*
	123317 123217	465	<input type="checkbox"/>		289*

1 AGUA

	123306	469	<input type="checkbox"/>		265
	123505	469	<input type="checkbox"/>		298*
	123506	469	<input type="checkbox"/>		248*

* Longitud del caño



MONOMANDOS

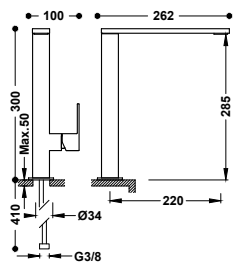

Grifo monomando para cocina
Con latiguillos de alimentación flexibles G3/8.

- 106486
- 006486NM
- 006486BM
- 50648603
- 0064860M

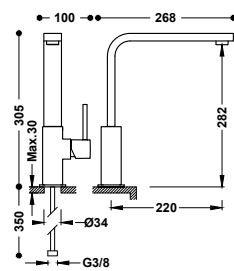

Grifo monomando para cocina
Con latiguillos de alimentación flexibles G3/8.

- 130496
- 030496NM
- 030496BM
- 53049603
- 0304960M

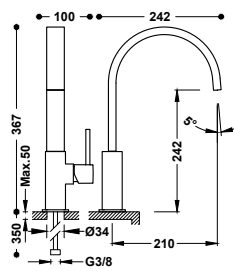

Grifo monomando para cocina
Con latiguillos de alimentación flexibles G3/8.

- 130498
- 030498NM
- 030498BM
- 53049803
- 0304980M

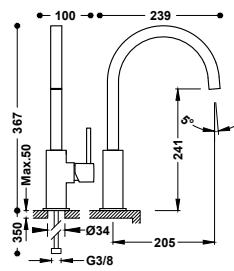

Grifo monomando para cocina
Con latiguillos de alimentación flexibles G3/8.

- 130497
- 030497NM
- 030497BM
- 53049703
- 0304970M

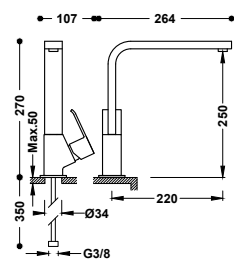



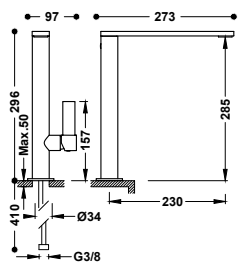

Grifo monomando para cocina
Con latiguillos de alimentación flexibles G3/8.

- 106440





Grifo monomando para cocina
Con latiguillos de alimentación flexibles G3/8.

-  20548601
-  20548601NM
-  20548601BM
-  20548601AC
-  20548601OM



9130190

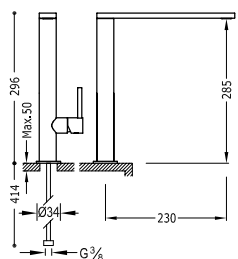

Grifo monomando para cocina
Con latiguillos de alimentación flexibles G3/8.





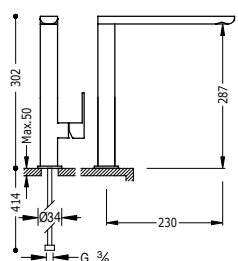

-  06248801



9130190



Grifo monomando para cocina
Con latiguillos de alimentación flexibles G3/8.





-  20044001
-  20044001NM
-  20044001BM
-  20044001AC
-  20044001OM
-  20044001NE

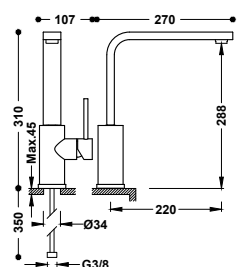

9130190



Grifo monomando para cocina
Con latiguillos de alimentación flexibles G3/8.

-  162435
-  062435NM
-  062435BM
-  062435AC
-  062435OM



9134592

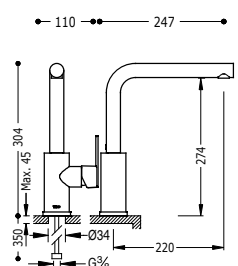

Grifo monomando para cocina
Con latiguillos de alimentación flexibles G3/8.

-  181436



9134592



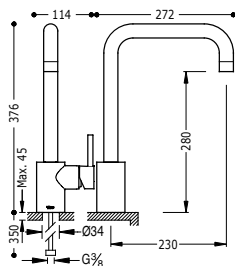

Grifo monomando para cocina
Con latiguillos de alimentación flexibles G3/8.

162441



9134290

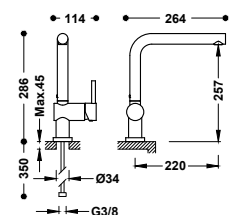

Grifo monomando para cocina
Con latiguillos de alimentación flexibles G3/8.

130336
030336BM
030336AC



9134288

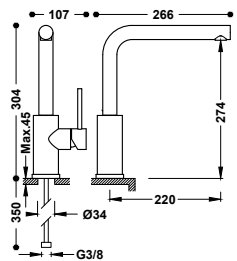

Grifo monomando para cocina
Con latiguillos de alimentación flexibles G3/8.

162436
06243601NM
06243601BM
06243601AC
06243601OM



9134592

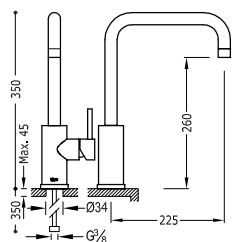

Grifo monomando para cocina
Con latiguillos de alimentación flexibles G3/8.

162541



9134592

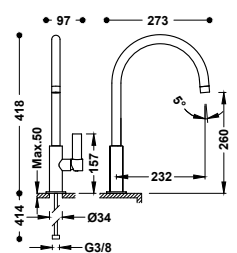

Grifo monomando para cocina
Con latiguillos de alimentación flexibles G3/8.

20544001
20544001NM
20544001BM
20544001AC
20544001OM



9130190

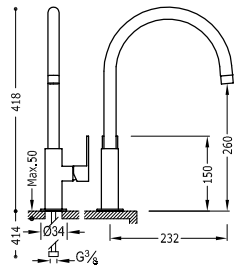

Grifo monomando para cocina

Con latiguillos de alimentación flexibles G3/8.

■ 20044002

■ 20044002NM

■ 20044002BM

■ 20044002AC

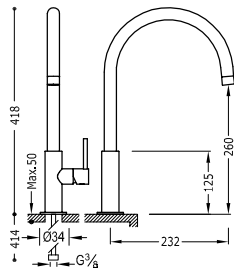

Grifo monomando para cocina

Con latiguillos de alimentación flexibles G3/8.

■ 06254201

■ 06254201NM

■ 06254201BM

■ 06254201AC

■ 06254201OM

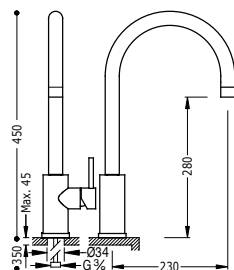

Grifo monomando para cocina

Con latiguillos de alimentación flexibles G3/8.

■ 162540

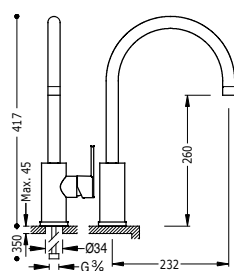

Grifo monomando para cocina

Con latiguillos de alimentación flexibles G3/8.

■ 181540

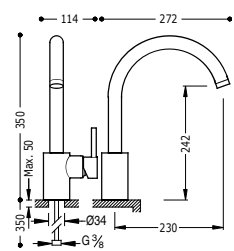

Grifo monomando para cocina

Con latiguillos de alimentación flexibles G3/8.

■ 162442



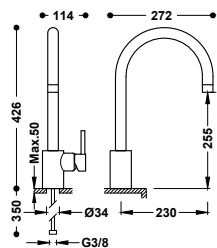

Grifo monomando para cocina
Con latiguillos de alimentación flexibles G3/8.

- 162440
- 56244003



9134290

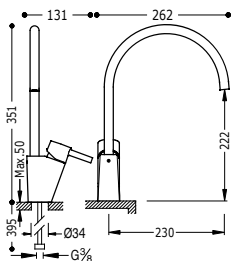

Grifo monomando para cocina
Con latiguillos de alimentación flexibles G3/8.

- 183341



9134592

1

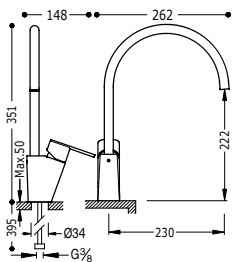

Grifo monomando para cocina
Con latiguillos de alimentación flexibles G3/8.

- 181341



9134592

1

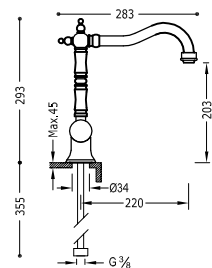

Grifo monomando para cocina
Con latiguillos de alimentación flexibles G3/8.

- 24234101
- 24234101AC
- 24234101OR
- 24234101LV
- 24234101LM



9134591

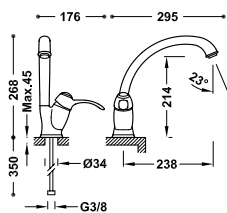

Grifo monomando para cocina
Con latiguillos de alimentación flexibles G3/8.

- 24244101
- 24244101AC
- 24244101OR
- 24244101LV
- 24244101LM



9134592

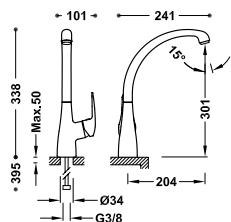

Grifo monomando para cocina
Con latiguillos de alimentación flexibles G3/8.

21644710



29903504

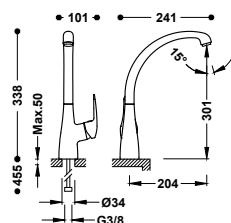

Grifo monomando para cocina
Con latiguillos de alimentación flexibles G3/8.

21644720



IIA

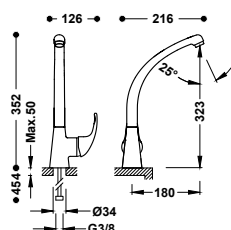

Grifo monomando para cocina
Con latiguillos de alimentación flexibles G3/8.

172447

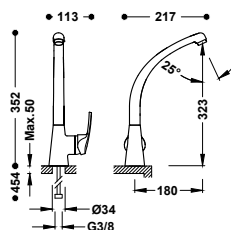

Grifo monomando para cocina
Con latiguillos de alimentación flexibles G3/8.

17044702

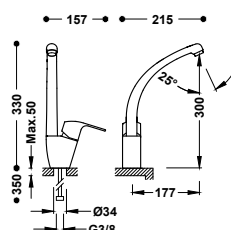

Grifo monomando para cocina
Con latiguillos de alimentación flexibles G3/8.

06944001



913427010

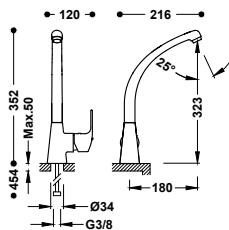

Grifo monomando para cocina
Con latiguillos de alimentación flexibles G3/8.

06944701



9134288

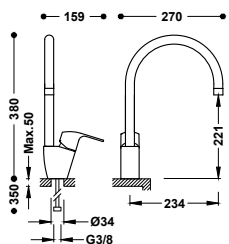

Grifo monomando para cocina
Con latiguillos de alimentación flexibles G3/8.

169440



913429510

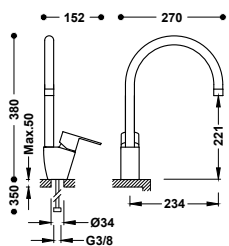

Grifo monomando para cocina
Con latiguillos de alimentación flexibles G3/8.

117440



913429510

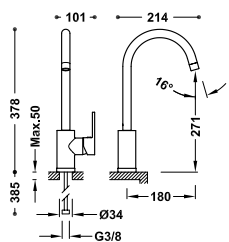

Grifo monomando para cocina
Con latiguillos de alimentación flexibles G3/8.

21644010



29903504

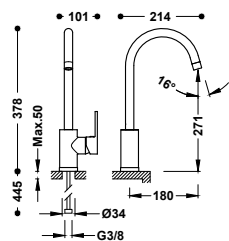

Grifo monomando para cocina
Con latiguillos de alimentación flexibles G3/8.

21644020



IIA

I

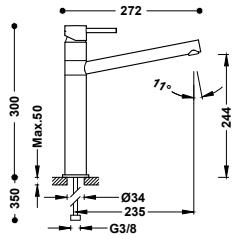

Grifo monomando para cocina
Con latiguillos de alimentación flexibles G3/8.

08333301



29903507

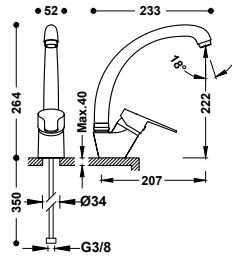

Grifo monomando para cocina
Con latiguillos de alimentación flexibles G3/8.

21544101



IA

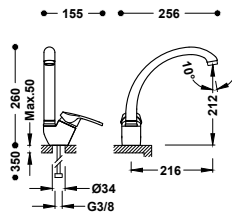

Grifo monomando para cocina
Con latiguillos de alimentación flexibles G3/8.

17044102

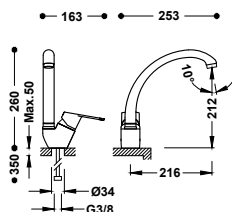

Grifo monomando para cocina
Con latiguillos de alimentación flexibles G3/8.

139441



913438510 IA

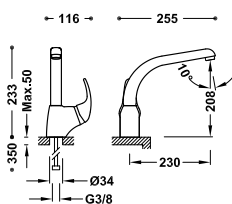

Grifo monomando para cocina
Con latiguillos de alimentación flexibles G3/8.

172440



IA

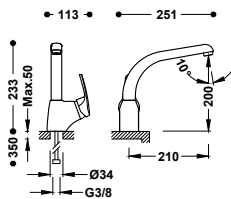

Grifo monomando para cocina
Con latiguillos de alimentación flexibles G3/8.

17044002

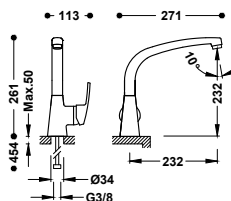

Grifo monomando para cocina
Con latiguillos de alimentación flexibles G3/8.

07044802

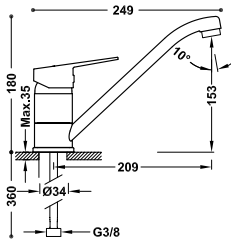

Grifo monomando para cocina
Con latiguillos de alimentación flexibles G3/8.

21533301

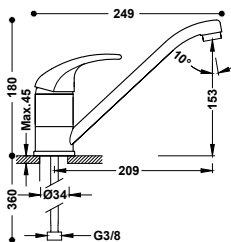

Grifo monomando para cocina
Con latiguillos de alimentación flexibles G3/8.

172333

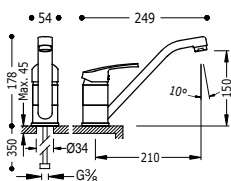

Grifo monomando para cocina
Con latiguillos de alimentación flexibles G3/8.

17033302



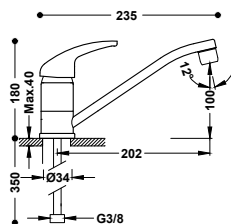

Grifo monomando para cocina
Con latiguillos de alimentación flexibles G3/8.

130337

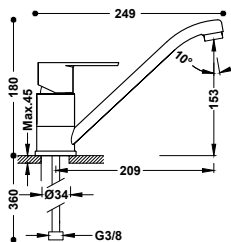

Grifo monomando para cocina
Con latiguillos de alimentación flexibles G3/8.

117333



A MURO

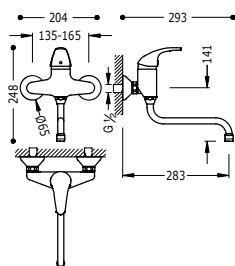

Grifo monomando mural para cocina
Con caño inferior. Distancia a pared: 283 mm.

172317

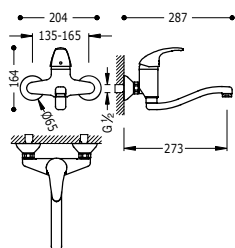

Grifo monomando mural para cocina
Con caño inferior. Distancia a pared: 273 mm.

172318

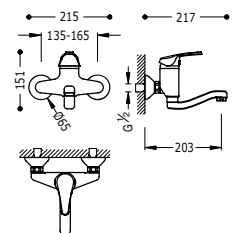

Grifo monomando mural para cocina
Con caño inferior. Distancia a pared: 203 mm.

07032003

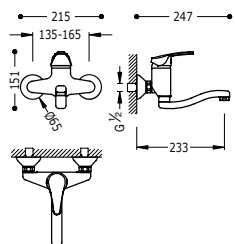

Grifo monomando mural para cocina
Con caño inferior. Distancia a pared: 233 mm.

17041802

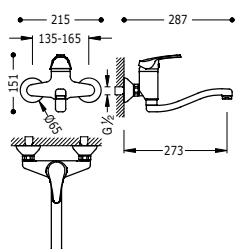

Grifo monomando mural para cocina
Con caño inferior. Distancia a pared: 273 mm.

17032002



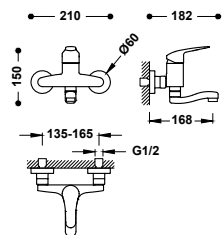

Grifo monomando mural para cocina
Con caño inferior. Distancia a pared: 168 mm.

21632010

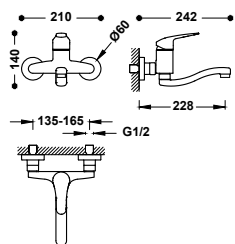

Grifo monomando mural para cocina
Con caño inferior. Distancia a pared: 228 mm.

21632020

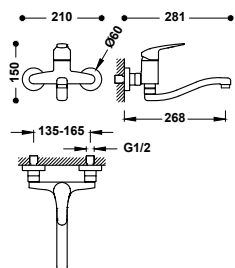

Grifo monomando mural para cocina
Con caño inferior. Distancia a pared: 268 mm.

21632030

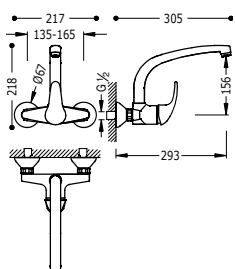

Grifo monomando mural para cocina
Con caño superior. Distancia a pared: 293 mm.

172420

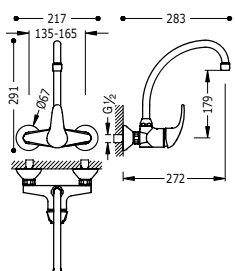

Grifo monomando mural para cocina
Con caño superior. Distancia a pared: 272 mm.

172418



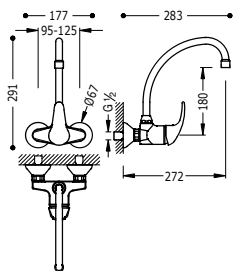

Grifo monomando mural para cocina

Con caño superior. Excentricidad especial. Distancia a pared: 272 mm.

172218

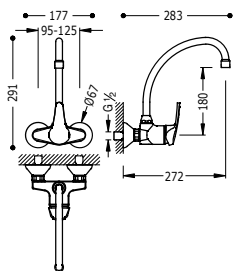

Grifo monomando mural para cocina

Con caño superior. Excentricidad especial. Distancia a pared: 272 mm.

17021802

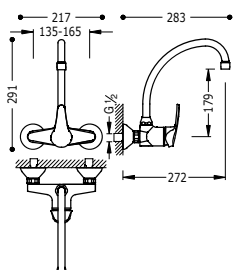

Grifo monomando mural para cocina

Con caño superior. Distancia a pared: 272 mm.

17031802

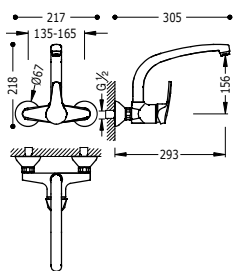

Grifo monomando mural para cocina

Con caño superior. Distancia a pared: 293 mm.

17033202

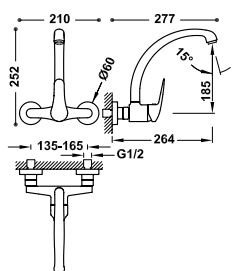

Grifo monomando mural para cocina

Con caño superior. Distancia a pared: 264 mm.

21642010



CON CAÑO FLEXIBLE

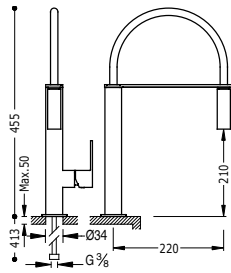

Grifo monomando con caño flexible para cocina
Con latiguillos de alimentación flexible G3/8.

-  00648701
-  00648701NM
-  00648701BM
-  00648701AC

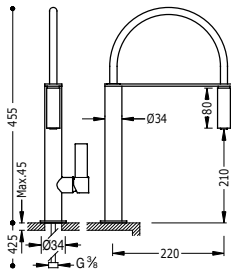

Grifo monomando con caño flexible para cocina
Con latiguillos de alimentación flexible G3/8.

-  20548702
-  20548702NM
-  20548702BM
-  20548702AC

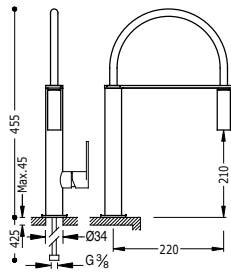

Grifo monomando con caño flexible para cocina
Con latiguillos de alimentación flexible G3/8.

-  03048701

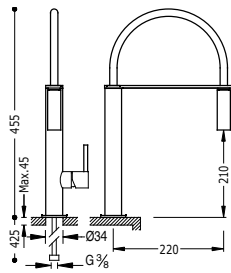

Grifo monomando con caño flexible para cocina
Con latiguillos de alimentación flexible G3/8.

-  06248702



Filtro anticloro

Agua de red y agua purificada en un mismo grifo



Convierte el agua del grifo en agua recién filtrada con buen sabor inmediatamente.



Elimina el mal sabor que produce el cloro pero respetando las propiedades minerales del agua de red.



Evita tener que cargar con botellas de agua, reduciendo el impacto medioambiental.



Agua filtrada hasta 4000 litros. El filtro se sustituye fácilmente sin necesidad de cortar el flujo del agua.

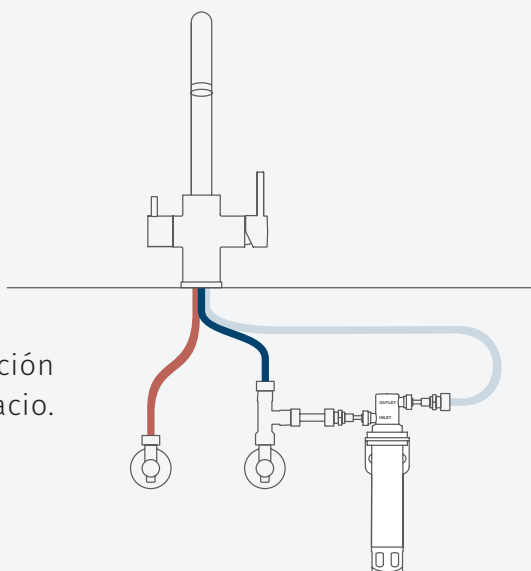

Mínima instalación en el mínimo espacio.

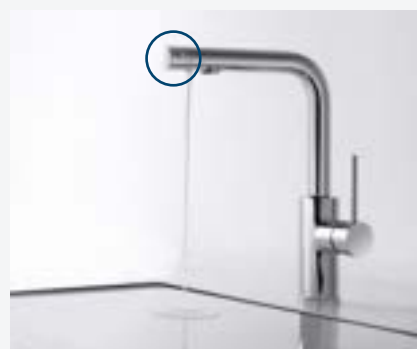

1 62 453

El cierre está incorporado justo en la salida del agua, eliminando el contacto del agua con el aire, evitando su contaminación.



030 355 01

Funciona con dos mandos convencionales, haciendo más cómodo su manejo.

PARA TRATAMIENTO DE AGUA

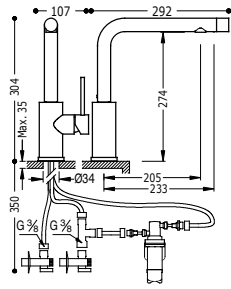

Grifo monomando doble para agua de red y filtrada para cocina

162453

Con filtro anticloro incorporado. Cierre y regulación de caudal independientes. 4.000 litros de agua sin cloro. Elimina el cloro y los compuestos orgánicos volátiles. No elimina la cal ni los minerales del agua. Latiguillos de alimentación flexible G3/8.

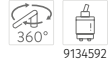

9134592

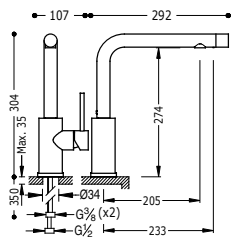

Grifo monomando doble para agua de red y filtrada para cocina

162456

Sin filtro anticloro. Cierre y regulación de caudal independientes. Grifo adaptable a instalaciones con tratamiento de agua. Latiguillos de alimentación flexible G3/8.



9134592

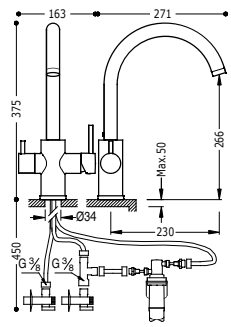

Grifo monomando doble para agua de red y filtrada para cocina

03035501

Con filtro anticloro incorporado. Cierre y regulación de caudal independientes. 4.000 litros de agua sin cloro. Elimina el cloro y los compuestos orgánicos volátiles. No elimina la cal ni los minerales del agua. Latiguillos de alimentación flexible G3/8.



9134592

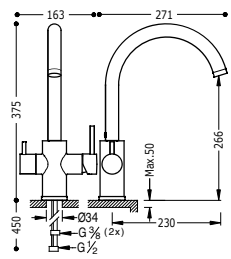

Grifo monomando doble para agua de red y filtrada para cocina

03045501

Sin filtro anticloro. Cierre y regulación de caudal independientes. Grifo adaptable a instalaciones con tratamiento de agua. Latiguillos de alimentación flexible G3/8.



9134592

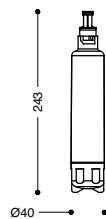

Filtro anticloro para modelos posteriores al año 2010

16235590

Solo filtro. Conexiones no incluidas.



CON CAÑO EXTRAÍBLE

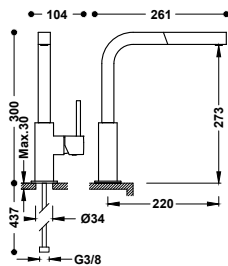

Grifo monomando con caño extraíble para cocina
Con latiguillos de alimentación flexible G3/8.

- 106437
- 006437NM
- 006437BM
- 50643703
- 0064370M



910719005

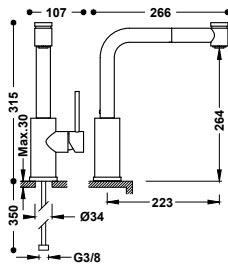

Grifo monomando con caño extraíble con 2 tipos de chorro para cocina
Con latiguillos de alimentación flexible G3/8.

- 162438



9134591

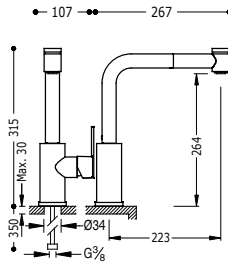

Grifo monomando con caño extraíble con 2 tipos de chorro para cocina
Con latiguillos de alimentación flexible G3/8.

- 181438



9134591

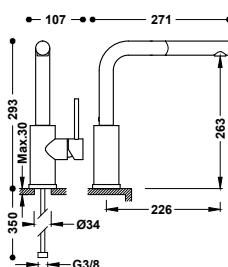

Grifo monomando con caño extraíble para cocina
Con latiguillos de alimentación flexible G3/8.

- 162437
- 56243703



9134591

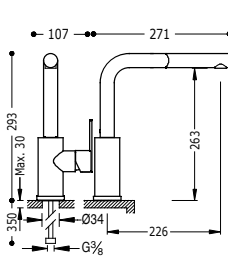

Grifo monomando con caño extraíble para cocina
Con latiguillos de alimentación flexible G3/8.

- 181437



9134591

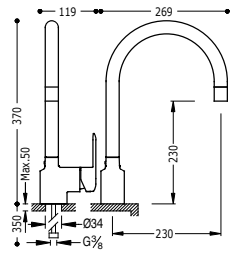

Grifo monomando con caño extraíble para cocina
Con latiguillos de alimentación flexible G3/8.

114444



9134288

BELOAGUA

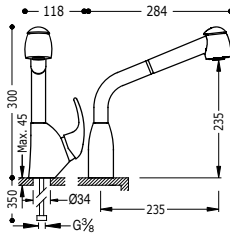

Grifo monomando con caño extraíble con 2 tipos de chorro para cocina
Con latiguillos de alimentación flexibles G3/8.

03044401



360°

BELOAGUA

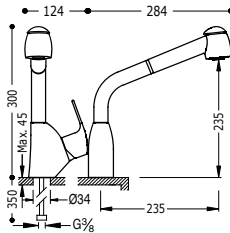

Grifo monomando con caño extraíble con 2 tipos de chorro para cocina
Con latiguillos de alimentación flexibles G3/8.

06944401



360°

9134288

BELOAGUA

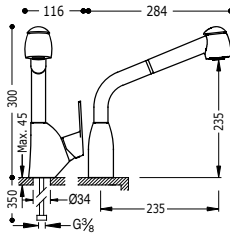

Grifo monomando con caño extraíble con 2 tipos de chorro para cocina
Con latiguillos de alimentación flexibles G3/8.

03944401

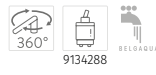

360°

9134288

BELOAGUA

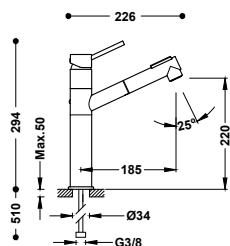

Grifo monomando con caño extraíble con 2 tipos de chorro para cocina
Con latiguillos de alimentación flexibles G3/8.

03043401



100°

29903507



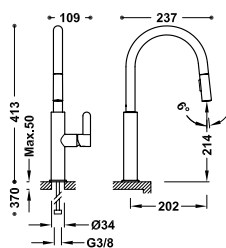

Grifo monomando con caño extraíble con 2 tipos de chorro para cocina

Con latiguillos de alimentación flexibles G3/8.

03043801



CON CAÑO ABATIBLE

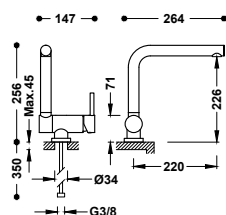

Grifo monomando con caño abatible para cocina

Con latiguillos de alimentación flexible G3/8.

130335

- 030335NM
- 030335BM
- 030335AC
- 030335OM



913438510

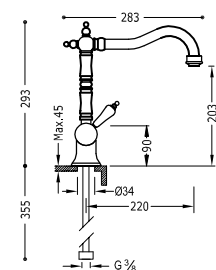

Grifo monomando con caño abatible para cocina

Con latiguillos de alimentación flexible G3/8.

24233401

- 24233401AC
- 24233401OR
- 24233401LV
- 24233401LM



9134591

BIMANDOS

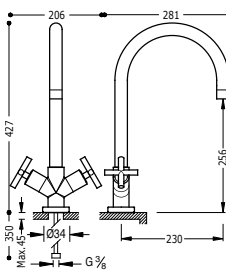

Grifo bimando para cocina

Con latiguillos de alimentación flexible G3/8.

163333

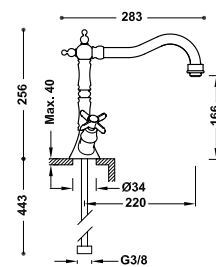

Grifo bimando para cocina

Con latiguillos de alimentación flexible G3/8.

24234201

- 24234201AC
- 24234201OR
- 24234201LV
- 24234201LM



9134282

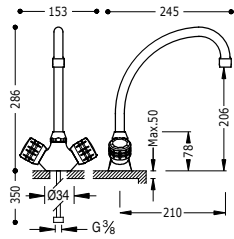

Grifo bimando para cocina

Con latiguillos de alimentación flexibles G3/8.

123342

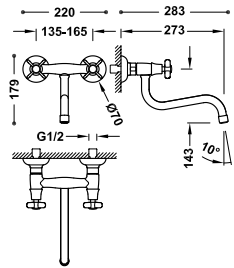

Grifo bimando mural para cocina

Con caño inferior. Distancia a pared: 273 mm.

24231001

- 24231001AC
- 24231001LV
- 24231001LM
- 24231001OR

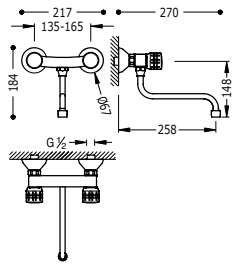

Grifo bimando mural para cocina

Con caño inferior. Distancia a pared: 258 mm.

123310

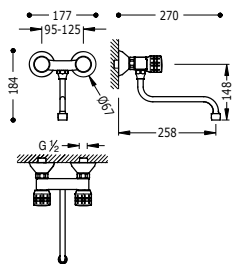

Grifo bimando mural para cocina

Con caño inferior. Excentricidad especial. Distancia a pared: 258 mm.

123210

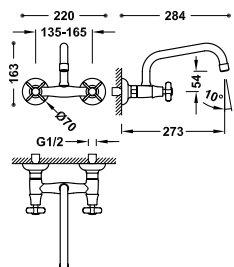

Grifo bimando mural para cocina

Con caño superior. Distancia a pared: 273 mm.

24221501

- 24221501AC
- 24221501LV
- 24221501LM
- 24221501OR



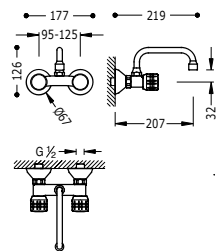

Grifo bimando mural para cocina

Con caño superior. Excentricidad especial. Distancia a pared: 207 mm.

123214

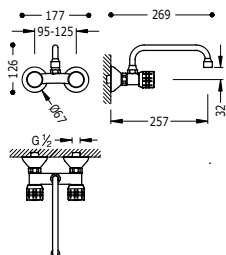

Grifo bimando mural para cocina

Con caño superior. Excentricidad especial. Distancia a pared: 257 mm.

123215

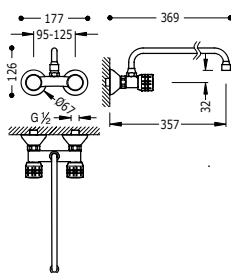

Grifo bimando mural para cocina

Con caño superior. Excentricidad especial. Distancia a pared: 357 mm.

123230

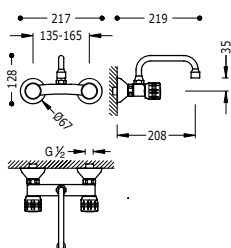

Grifo bimando mural para cocina

Con caño superior. Distancia a pared: 208 mm.

123314

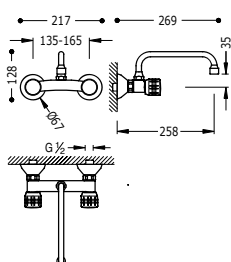

Grifo bimando mural para cocina

Con caño superior. Distancia a pared: 258 mm.

123315



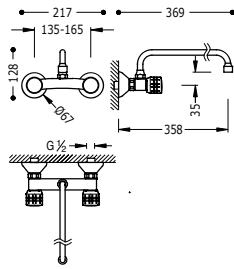

Grifo bimando mural para cocina
Con caño superior. Distancia a pared: 358 mm.

■ 123330

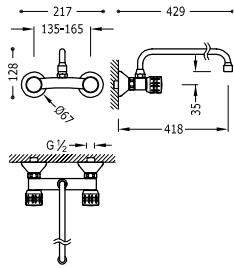

Grifo bimando mural para cocina
Con caño superior. Distancia a pared: 418 mm.

■ 123360

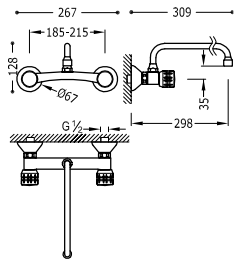

Grifo bimando mural para cocina
Con caño superior. Excentricidad especial. Distancia a pared: 298 mm.

■ 123416

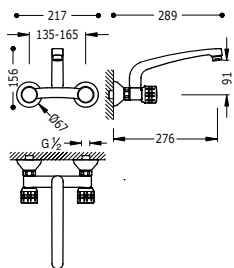
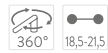

Grifo bimando mural para cocina
Con caño superior. Distancia a pared: 276 mm.

■ 123317

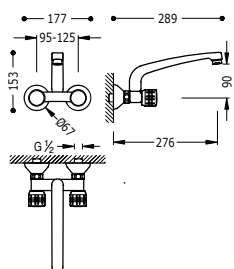

Grifo bimando mural para cocina
Con caño superior. Excentricidad especial. Distancia a pared: 276 mm.

■ 123217

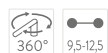

INDUSTRIALES

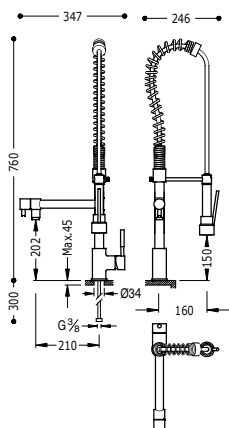

Grifo monomando doble con ducha extraíble para cocina industrial

Con latiguillos de alimentación flexibles G3/8.

130495

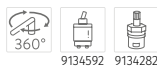

9134592 9134282

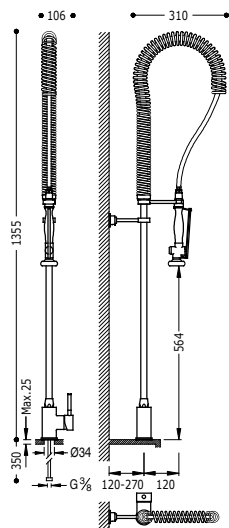

Grifo monomando con ducha extraíble para cocina industrial

Con latiguillos de alimentación flexibles G3/8.

130484



9134290

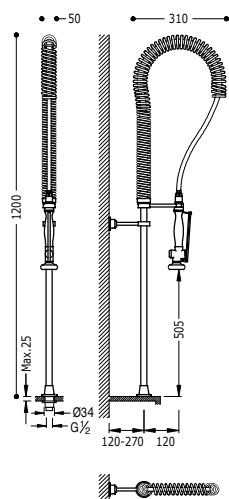

Ducha extraíble para cocina industrial con toma de agua a superficie de fregadero

Sin complementos. A completar con un grifo de pedal o grifo monomando empotrado.

130481



360°

Grifo monomando con ducha extraíble con 2 tipos de chorro para cocina industrial

03048501

Con latiguillos de alimentación flexibles G3/8.

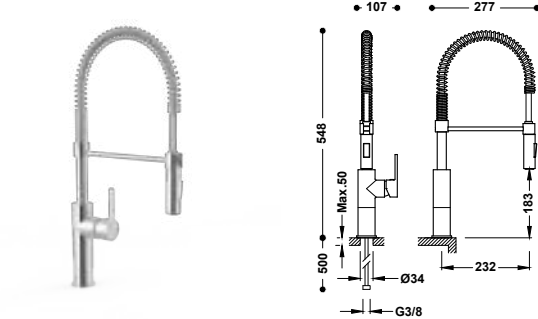

Grifo monomando con ducha extraíble con 2 tipos de chorro para cocina industrial

03049301

Con latiguillos de alimentación flexibles G3/8.

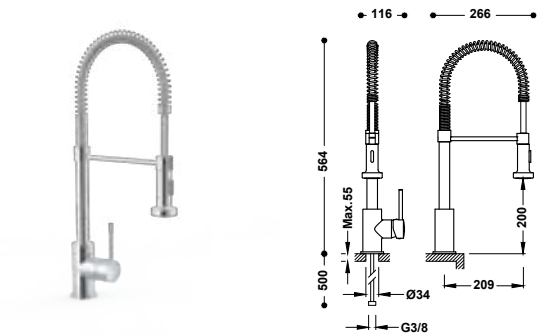

Caño giratorio para grifo de pedal

112441

Con enlace.

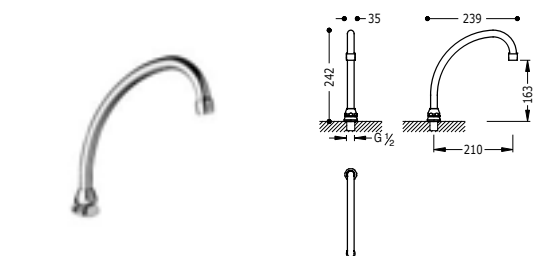

Grifo de pedal con mezclador de 2 aguas

112370

Presionando el pedal aumenta progresivamente la temperatura del agua, siempre con un caudal constante.

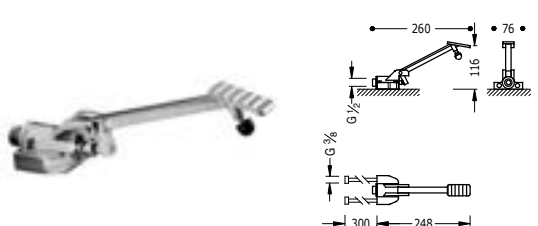

ELECTRÓNICOS

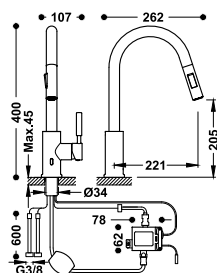

Grifo electrónico con caño extraíble y 2 tipos de chorro para cocina

09244501AC

Accionado mediante sensor de infrarrojos. Con regulador de caudal y temperatura a través de una maneta lateral. Material: Acero inoxidable.

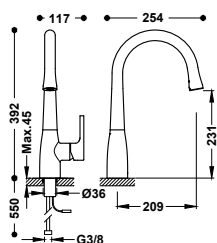

Grifo electrónico para cocina

09244601

Accionado mediante sensor de infrarrojos situado detrás de la salida del agua. Con regulador de caudal y temperatura a través de una maneta lateral.

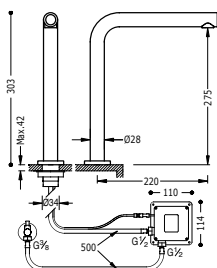

Grifo electrónico de 1 agua para cocina

161445

Sistema sensible al tacto TOUCH-TRES. Con latiguillos de alimentación flexible G3/8.

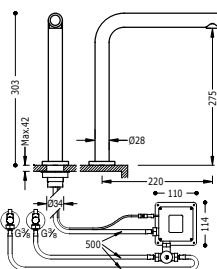

Grifo electrónico con sistema premezclador para cocina

161446

Sistema sensible al tacto TOUCH-TRES. Incluye una válvula mezcladora de 2 aguas con tubos flexibles (ref.: 19250730). Con latiguillos de alimentación flexible G3/8.



GRIFOS PARA VARIOS USOS

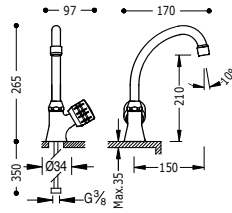

Grifo de 1 agua con volante lateral para office o lavadero
Con latiguillo de alimentación flexible G3/8.

123306

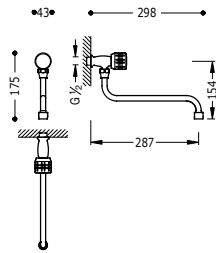

Grifo mural de 1 agua para office o lavadero
Con caño inferior. Distancia a pared: 287 mm.

123505

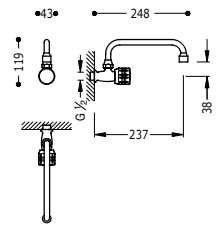

Grifo mural de 1 agua para office o lavadero
Con caño superior. Distancia a pared: 237 mm.

123506

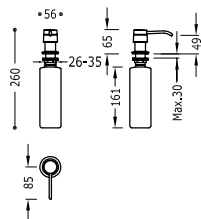

Dispensador de jabón empotrado a encimera
Para encimeras o fregaderos. Capacidad: 0,4 litros. Material: Metálico.

13474110

- 13474110NM
- 13474110BM
- 13474110AC
- 13474110OM

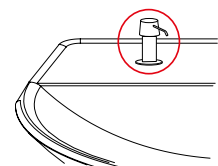

COLECTIVIDADES





Grifos temporizados	472
Grifos medicales	477
Grifos para peluquería	478
Grifos para exterior	479

GRIFOS TEMPORIZADOS PARA LAVABO

Grifo temporizado de 1 agua para lavabo

Cierre automático: 6 seg. Caudal: 0,7 l x ciclo.

20511201

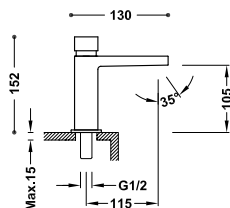

Grifo temporizado de 1 agua con sistema premezclador para lavabo

Cierre automático: 6 seg. Incluye una válvula mezcladora de 2 aguas con tubos flexibles (ref.: 19250730). Caudal: 0,7 l x ciclo.

20511202

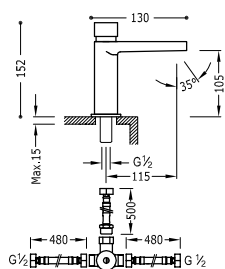

Grifo temporizado de 1 agua para lavabo

Cierre automático: 4,7 seg. Caudal: 0,4 l x ciclo.

01210303

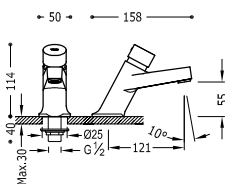

Grifo temporizado de 1 agua para lavabo

Cierre automático: 5,7 seg. Caudal: 0,5 l x ciclo.

01210302

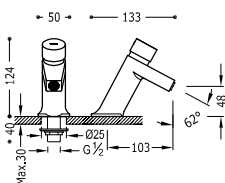

Grifo temporizado de 1 agua para lavabo

Conexión roscada macho de G1/2. Cierre automático: 4,5 seg. Caudal: 0,6 l x ciclo.

21210301

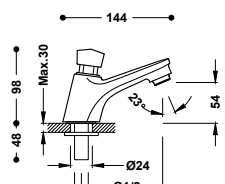

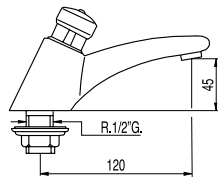

Grifo temporizado de 1 agua para lavabo

Conexión roscada macho de G1/2. Cierre automático: 10,8 seg.
Caudal: 1,2 l x ciclo.

112103

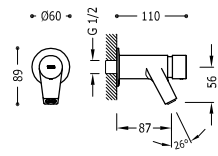

Grifo temporizado mural de 1 agua para lavabo

Conexión roscada macho de G1/2. Cierre automático: 6 seg.
Caudal: 0,5 l x ciclo.

01210002

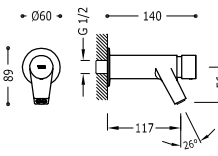

Grifo temporizado mural de 1 agua para lavabo

Conexión roscada macho de G1/2. Cierre automático: 6 seg.
Caudal: 0,5 l x ciclo.

01210003

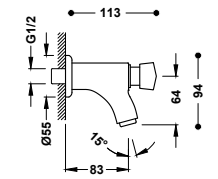

Grifo temporizado mural de 1 agua para lavabo

Conexión roscada macho de G1/2. Cierre automático: 4 seg.
Caudal: 0,8 l x ciclo.

21210001

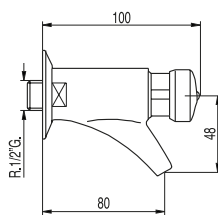

Grifo temporizado mural de 1 agua para lavabo

Conexión roscada macho de G1/2. Cierre automático: 14 seg.
Caudal: 1,5 l x ciclo.

112100



GRIFOS TEMPORIZADOS PARA URINARIO

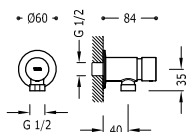

Grifo de descarga temporizado mural de 1 agua para urinario

01220002

Conexión roscada macho de G1/2. Cierre automático: 6 seg. Caudal: 0,7 l x ciclo.

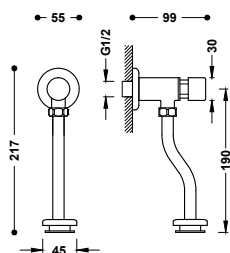

Grifo temporizado mural de 1 agua para urinario

21220001

Con un tubo adaptable al urinario. Cierre automático: 5 seg. Caudal: 1,5 l x ciclo.

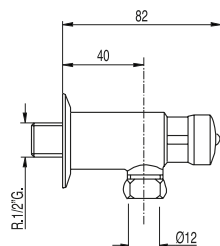

Grifo temporizado mural de 1 agua para urinario

112200

Conexión roscada macho de G1/2. Cierre automático: 4,8 seg. Caudal: 0,9 l x ciclo.

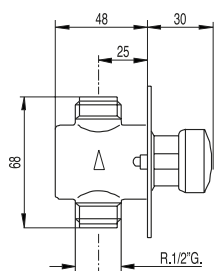

Grifo de descarga temporizado empotrado de 1 agua para urinario

01220801

Cuerpo empotrado incluido. Conexión roscada G1/2. Cierre automático: 4 seg. Caudal: 0,7 l x ciclo.

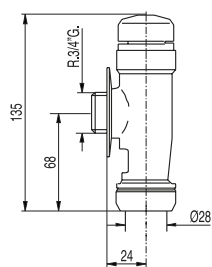

Grifo de descarga temporizado mural de 1 agua para urinario

112205

Conexión roscada macho G3/4. Salida de agua para tubo 26x28. Cierre automático: 3,5 seg. Caudal: 5,3 l x ciclo.





Tubo de descarga para grifo temporizado mural de urinario

13420503

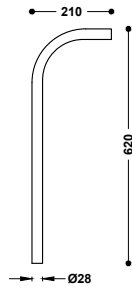

GRIFOS TEMPORIZADOS PARA DUCHA



Grifo temporizado mural de 1 agua para ducha

112167

Cierre automático: 15 seg. Caudal: 16 l/min.

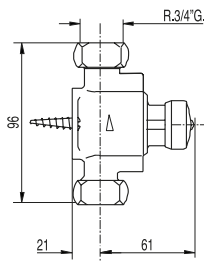

Conjunto de grifo temporizado mural de 1 agua para ducha

112161

Regulador automático de caudal incorporado en el rociador. Caudal: 8-10 l/min.

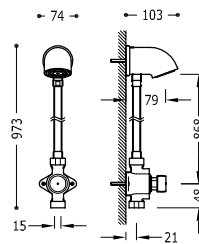

Conjunto de grifo temporizado mural con selector de temperatura para ducha

112163

Regulador automático de caudal incorporado en el rociador. Caudal: 8-10 l/min. Entradas opuestas con racores extensibles y válvulas antirretorno.

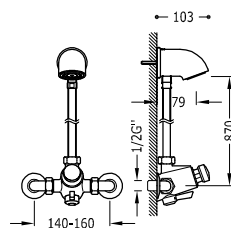

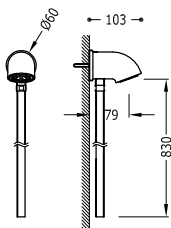

Rociador mural para ducha con tubo de conexión

Con tubo de conexión. Regulador automático de caudal incorporado en el rociador. Caudal: 8-10 l/min.

11216150

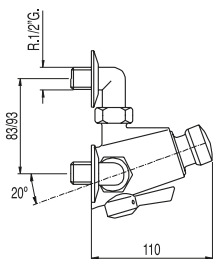

Grifo temporizado mural con selector de temperatura para ducha

Entradas opuestas con racores extensibles y válvulas antirretorno. Caudal: 16 l/min.

112162

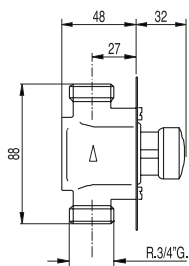

Grifo temporizado empotrado de 1 agua para ducha

Entrada y salida con rosca G3/4. Caudal: 20 l/min.

112178

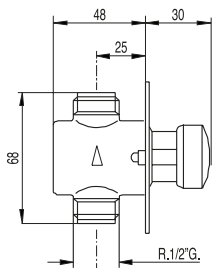

Grifo temporizado empotrado de 1 agua para ducha

Entrada y salida con rosca G1/2. Caudal: 16 l/min.

112177

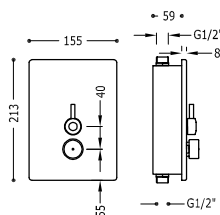

Grifo temporizado empotrado con selector de temperatura para ducha

2 entradas y 1 salida de agua con rosca G1/2.

01217901

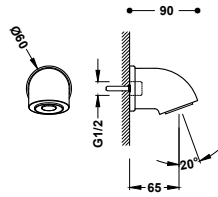

Rociador mural antivandálico para ducha

Regulador automático de caudal incorporado en el rociador.
Caudal: 6 l/min.

13416803

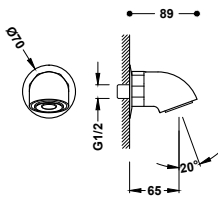

Rociador mural para ducha

Regulador automático de caudal incorporado en el rociador.
Caudal: 8-10 l/min. Conexión roscada macho G1/2.

13416703

GRIFOS MEDICALES

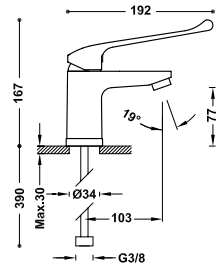

Grifo monomando medical

Con latiguillos de alimentación flexibles G3/8.

2161030111

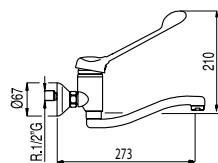

Grifo monomando medical mural

Con caño inferior. Distancia a pared: 273 mm.

17231811

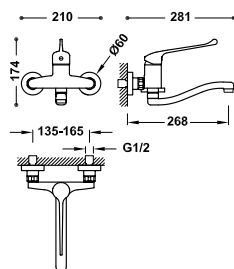
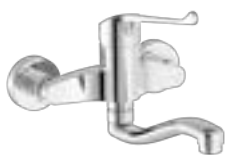

Grifo monomando medical mural

Con caño inferior. Distancia a pared: 268 mm.

2163200311



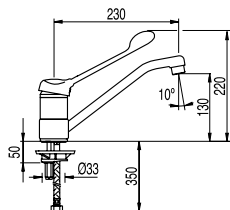

Grifo monomando medical
Con latiguillos de alimentación flexibles G3/8.

■ 17233311

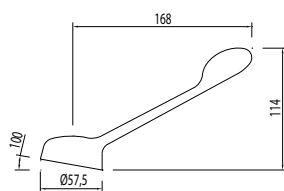

Palanca medical para grifo monomando
(para ref.: 1701030211, 17231811, 17233311)

■ 9134011



GRIFOS PARA PELUQUERÍA

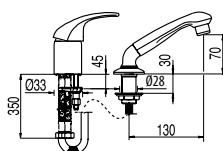

Grifo monomando para lavacabezas de peluquería
Con ducha de mano extraíble.

■ 172450

GRIFOS PARA EXTERIOR

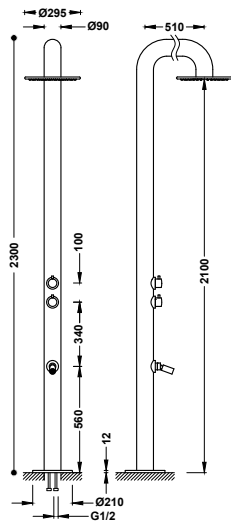

Columna de ducha para jardín o piscina de acero inoxidable 316

13499504

- Fabricada en acero inoxidable 316.
- Con tratamiento para exteriores que impide su deterioro.
- Con tomas de agua a suelo.
- Rociador de ducha fija Ø 295 mm. con sistema anticálcero.
- Grifo lavapiés con rótula orientable.
- Dispone de un mando para regular el caudal de ambas salidas y otro para controlar la temperatura.

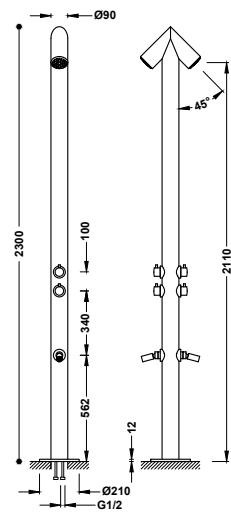

Columna con doble ducha para jardín o piscina de acero inoxidable 316

13499502

- Fabricada en acero inoxidable 316.
- Con tratamiento para exteriores que impide su deterioro.
- Con tomas de agua a suelo.
- Dos rociadores con sistema anticálcero.
- Dos grifos lavapiés con rótula orientable.
- Cada rociador dispone de un mando para regular el caudal de ambas salidas y otro para controlar la temperatura.

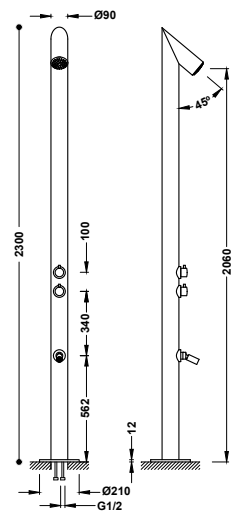

Columna de ducha para jardín o piscina de acero inoxidable 316

13499501

- Fabricada en acero inoxidable 316.
- Con tratamiento para exteriores que impide su deterioro.
- Con tomas de agua a suelo.
- Rociador con sistema anticálcero.
- Grifo lavapiés con rótula orientable.
- Dispone de un mando para regular el caudal de ambas salidas y otro para controlar la temperatura.

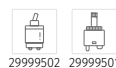

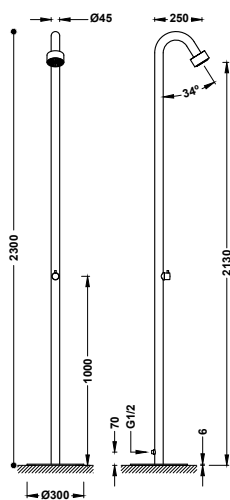

Columna de ducha de 1 agua para jardín o piscina de acero inoxidable 316

13499503

- Fabricada en acero inoxidable 316.
- Con tratamiento para exteriores que impide su deterioro.
- Toma de agua mediante una conexión a manguera G1/2.
- Ducha superior con sistema anticalcáreo.

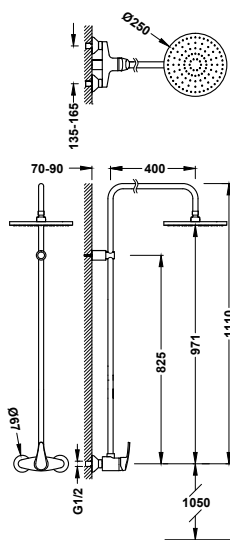

Conjunto de grifo monomando mural de 1 vía para jardín o piscina

07099501

- Rociador de ducha orientable: Ø 250 mm.

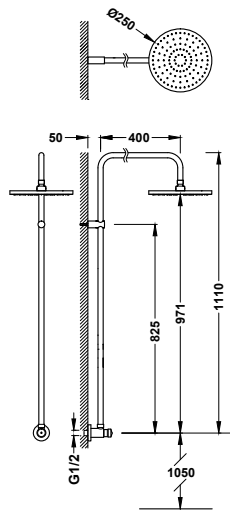

Conjunto de grifo temporizado mural de 1 agua para jardín o piscina

01299601

- Rociador de ducha orientable: Ø 250 mm.

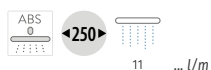

Grifo mural de 1 agua para jardín
con aireador.

03450101

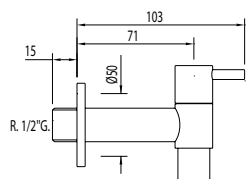

Grifo mural de 1 agua con conexión rápida a manguera

03450102

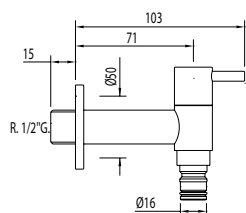

COMPLEMENTOS DE GRIFERÍA





Válvulas y desagües 484

Sifones 494

Llaves de paso 497

Conexiones acodadas y alargaderas 499

Caños 501

Florones 504

Excéntricas 505

Válvulas de vaciado 506

WC SYSTEMS 508

Mecanismos de llenado 510

Mecanismos de descarga 511

















TRES CLEANER 514

Limpiador de grifería 516



VÁLVULAS SIMPLE-RAPID PARA LAVABO

Válvula de desagüe Click-Clack Simple-Rapid para lavabo
 Apto para lavamanos con y sin rebosadero. Función Click-Clack. Tapón Ø 63 mm. Simple-Rapid fácil instalación.

-  24284001
-  24284001NM
-  24284001BM
-  24284001AC
-  24284001KM
-  24284001KMB
-  24284001OR
-  24284001OM
-  24284001OP
-  24284001OPM
-  24284001LV
-  24284001LM
-  24284001AM
-  24284001RO
-  24284001NE
-  24284001BL

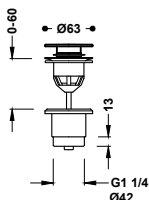

Válvula de desagüe Click-Clack Simple-Rapid para lavabo
 Apto para lavamanos con y sin rebosadero. Función Click-Clack. Tapón Ø 40 mm. Simple-Rapid fácil instalación.

-  24284002
-  24284002NM
-  24284002BM
-  24284002AC
-  24284002KM
-  24284002KMB
-  24284002OR
-  24284002OM
-  24284002OP
-  24284002OPM
-  24284002LV
-  24284002LM
-  24284002AM
-  24284002RO
-  24284002NE
-  24284002BL

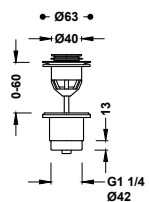

Válvula de desagüe Click-Clack Simple-Rapid para lavabo con opción siempre abierta
 Incluye un adaptador que da la opción para que el tapón siempre quede abierto. Apto para lavamanos con y sin rebosadero.

 24284010



También disponible con acabados (mirar web):

- 
 - 
 - 
 - 
 - 
 - 
 - 
 - 
 - 
 - 
 - 
 - 
 - 
 - 
 - 
- NM BM AC KM KMB OR OM OP OPM LV LM AM RO NE BL

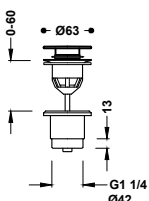

Válvula de desagüe Click-Clack Simple-Rapid para lavabo con opción siempre abierta
 Incluye un adaptador que da la opción para que el tapón siempre quede abierto. Apto para lavamanos con y sin rebosadero.

 24284020



También disponible con acabados (mirar web):

- 
 - 
 - 
 - 
 - 
 - 
 - 
 - 
 - 
 - 
 - 
 - 
 - 
 - 
 - 
- NM BM AC KM KMB OR OM OP OPM LV LM NE BL

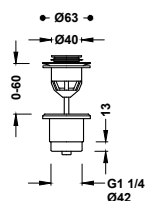

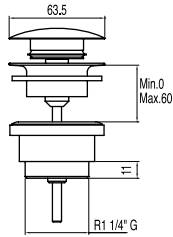

Válvula de desagüe Click-Clack Simple-Rapid para lavabo

Apto para lavamanos con y sin rebosadero. Función Click-Clack.
Tapón: Ø 63,5 mm. Simple-Rapid fácil instalación.

161840

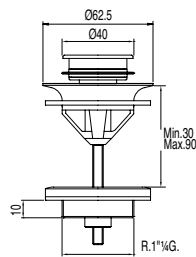

Válvula de desagüe Click-Clack Simple-Rapid para lavabo

Apto para lavamanos con y sin rebosadero. Función Click-Clack.
Tapón: Ø 40 mm. Simple-Rapid fácil instalación.

162840

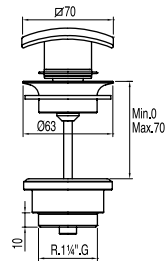

Válvula de desagüe Click-Clack Simple-Rapid para lavabo

Apto para lavamanos con y sin rebosadero. Función Click-Clack.
Tapón: Ø 70x70 mm. Simple-Rapid fácil instalación.

107940

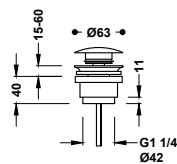

Válvula de desagüe Click-Clack Simple-Rapid para lavabo

Apto para lavamanos con y sin rebosadero. Función Click-Clack.
Tapón: Ø 63 mm. Simple-Rapid fácil instalación.

13454010

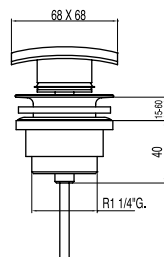

Válvula de desagüe Click-Clack Simple-Rapid para lavabo

Apto para lavamanos con y sin rebosadero. Función Click-Clack.
Tapón: 68x68 mm. Simple-Rapid fácil instalación.

13434010



VÁLVULAS PARA LAVABO SIN REBOSADERO

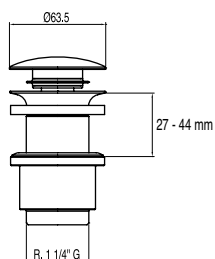

Válvula de desagüe Click-Clack para lavabo sin rebosadero

Para encimeras de madera de 27-44 mm. Sin rebosadero. Función Click-Clack. Tapón: Ø 63.5 mm.

13494010

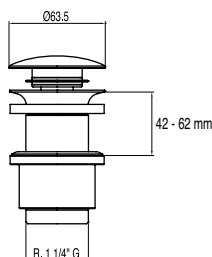

Válvula de desagüe Click-Clack para lavabo sin rebosadero

Para encimeras de madera de 42-62 mm. Sin rebosadero. Función Click-Clack. Tapón: Ø 63.5 mm.

13494110

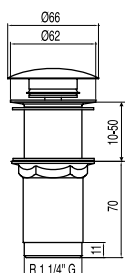

Válvula de desagüe Click-Clack para lavabo sin rebosadero

Sin rebosadero. Función Click-Clack. Tapón: Ø 66 mm.

13454060

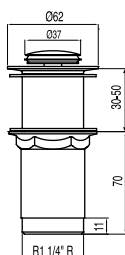

Válvula de desagüe Click-Clack para lavabo sin rebosadero

Sin rebosadero. Función Click-Clack. Tapón: Ø 37 mm.

13454050

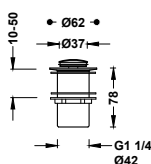

Válvula de desagüe Click-Clack para lavabo sin rebosadero

Sin rebosadero. Función Click-Clack. Tapón: Ø 37 mm.

13454070

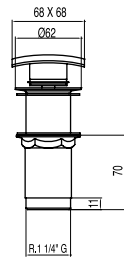

Válvula de desagüe Click-Clack para lavabo sin rebosadero
Sin rebosadero. Función Click-Clack. Tapón: 68x68 mm.

13434120

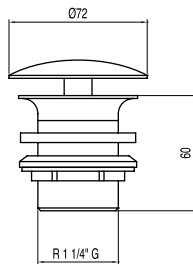

Válvula de desagüe siempre abierto para lavabo sin rebosadero

Sin rebosadero. Tapón: Ø 72 mm.

13424010

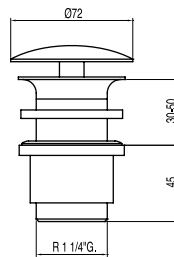

Válvula de desagüe siempre abierto para lavabo sin rebosadero

Sin rebosadero. Tapón: Ø 72 mm.

13424020

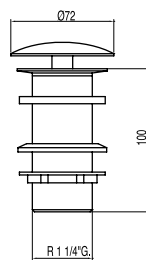

Válvula de desagüe siempre abierto para lavabo sin rebosadero

Sin rebosadero. Tapón: Ø 72 mm.

13424030

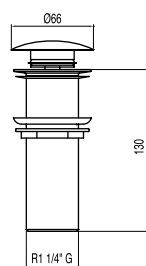

Válvula de desagüe Click-Clack para lavabo sin rebosadero
Sin rebosadero. Función Click-Clack. Tapón: Ø 66 mm.

13454030



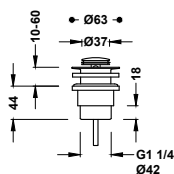

Válvula de desagüe Click-Clack para lavabo sin rebosadero
Sin rebosadero. Función Click-Clack. Tapón: Ø 37 mm.

134215026

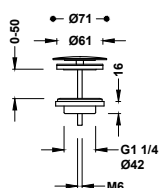

Válvula de desagüe siempre abierto para lavabo sin rebosadero
Sin rebosadero. Tapón: Ø 71 mm.

134215028

VÁLVULAS PARA LAVABO CON REBOSADERO

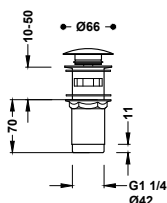

Válvula de desagüe Click-Clack para lavabo con rebosadero
Con rebosadero. Función Click-Clack. Tapón: Ø 66 mm.

13454160

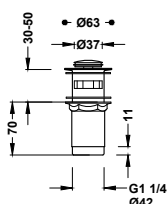

Válvula de desagüe Click-Clack para lavabo con rebosadero
Con rebosadero. Función Click-Clack. Tapón: Ø 37 mm.

13454110

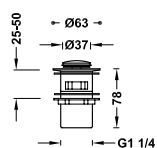

Válvula de desagüe Click-Clack para lavabo con rebosadero
Con rebosadero. Función Click-Clack. Tapón: Ø 37 mm.

13454190

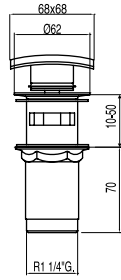

Válvula de desagüe Click-Clack para lavabo con rebosadero
Con rebosadero. Función Click-Clack. Tapón: 68x68 mm.

13434020

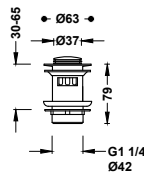

Válvula de desagüe Click-Clack para lavabo con rebosadero
Con rebosadero. Función Click-Clack. Tapón: Ø 37 mm.

134215025

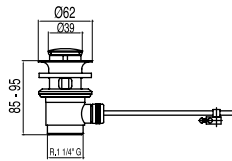

Válvula de desagüe automático para lavabo con rebosadero
Con rebosadero. Tapón: Ø 39 mm.

13474310

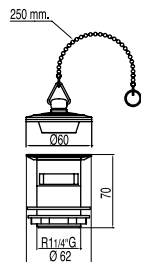

Válvula de desagüe con tapón y cadenilla para lavabo con rebosadero
Cadenilla de 250 mm.

13474320

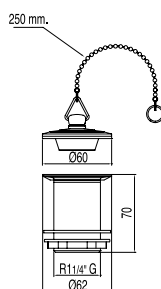

Válvula de desagüe con tapón y cadenilla para lavabo sin rebosadero
Cadenilla de 250 mm.

13474330



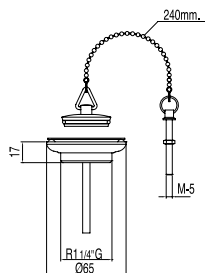

Cazoleta plana de desagüe con kit de enganche de cadena y tapón para lavabo, bidé y fregadero
Cadenilla de 240 mm.

13463910

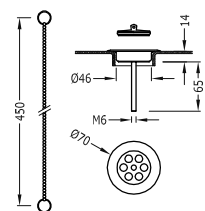

Cazoleta plana de desagüe con cadena y tapón para lavabo, bidé y fregadero
Cadenilla: 450 mm. Cazoleta: Ø 70 mm. Tapón metálico.

03474601

- 03474601AC
- 03474601OR
- 03474601OM
- 9134746051
- 03474601LM

COMPLEMENTOS PARA VÁLVULAS

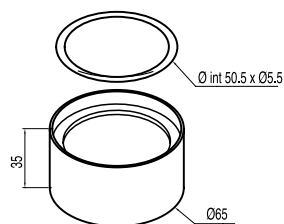

Separador para válvula de desagüe
Para lavamanos de sobre-encimera. Diámetro: Ø 65 mm.
Altura: 35 mm.

916110348

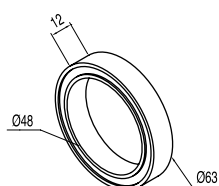
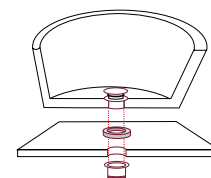

Separador para válvula de desagüe
Para lavamanos de sobre-encimera. Diámetro: Ø 63 mm.
Altura: 12 mm.

13463310

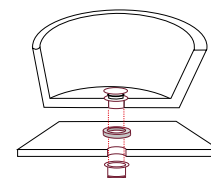

Tapón para válvula de desagüe Click-Clack

Función Click-Clack. Tapón: Ø 63.5 mm. Para ref.: 161840.

916184060

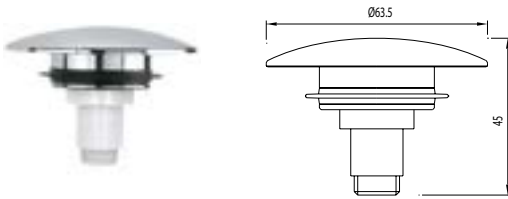

Adaptador para lavamanos de cristal o acero inoxidable que no poseen rebosadero

Con rebosadero. Tubo flexible: 320 mm.

13463450

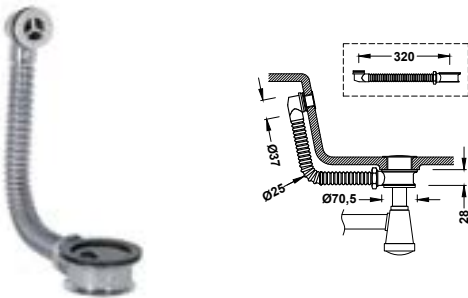

DESAGÜES PARA DUCHA O BAÑERA

Válvula de desagüe Click-Clack con rebosadero para bañera

Tapón: Ø 72 mm. Tubo flexible: máx. 680 mm.

13453420

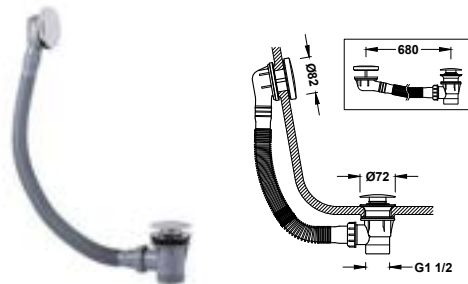

- 03453420NM
- 03453420BM
- 03453420AC
- 03453420KM
- 03453420KMB
- 03453420OR
- 03453420OM
- 03453420OP
- 03453420OPM
- 03453420LV
- 03453420LM



Válvula de desagüe redondo Click-Clack y de llenado con rebosadero para bañera

Tapón: Ø 70 mm. Tubo flexible: máx. 980 mm.

13453430

- 03453430NM
- 03453430BM
- 03453430AC
- 03453430KM
- 03453430KMB
- 03453430OR
- 03453430OM
- 03453430OP
- 03453430OPM
- 03453430LV
- 03453430LM

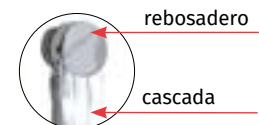
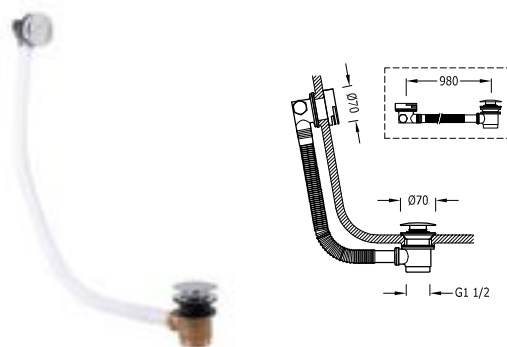

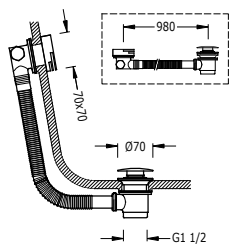

Válvula de desagüe cuadrado Click-Clack y de llenado con rebosadero para bañera

Tapón: \varnothing 70 mm. Tubo flexible: máx. 980 mm.

13453440

03453440NM

03453440AC

03453440OR

03453440OM

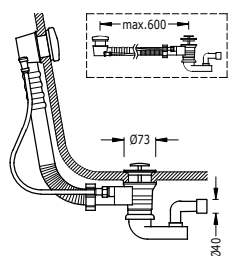
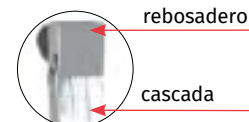

Válvula de desagüe automático para bañera con rebosadero

Con rebosadero. Se puede abrir y cerrar la válvula de desagüe girando el volante situado sobre el desaguadero. Tapón: \varnothing 43 mm. Tubo flexible: máx. 600 mm.

134846

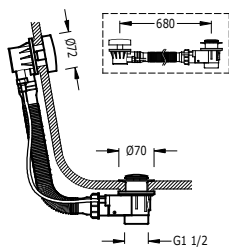

Válvula de desagüe automático para bañera con rebosadero

Con rebosadero. Se puede abrir y cerrar la válvula de desagüe girando el volante situado sobre el desaguadero. Tapón: \varnothing 43 mm. Tubo flexible: máx. 680 mm.

13453410

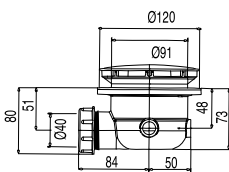

Desagüe sifónico inspeccionable para plato de ducha

Con sifón incorporado. Tapón: \varnothing 120 mm. Volumen de desagüe: 31 l/min.

104840

Desagüe sifónico inspeccionable para plato de ducha

104841

Con sifón incorporado. Tapón: \varnothing 118 mm. Volumen de desagüe: 62 l/min.

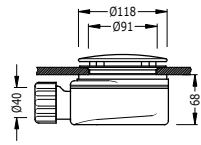

Válvula de desagüe Click-Clack para bañera

13474010

Función Click-Clack. Tapón: \varnothing 70 mm.

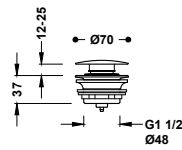

Válvula de desagüe Click-Clack con tapón oculto para bañera

134215027

Función Click-Clack. Tapón: \varnothing 36 mm.

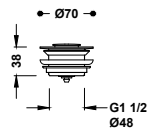

Desagüe para lavadero o similar

13474020

Tapón: \varnothing 72 mm.

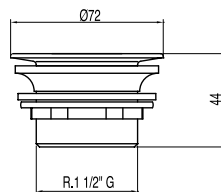

Cazoleta plana de desagüe con kit de enganche de cadena y tapón para bañera

03474501

Cadenilla: 450 mm. Cazoleta: \varnothing 70 mm. Tapón metálico.

- 03474501AC
- 03474501OR
- 03474501OM
- 9134745051
- 03474501LM

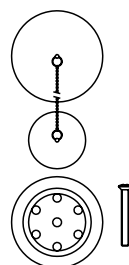

SIFONES

Sifón telescópico cuadrado inspeccionable con faldón para lavabo

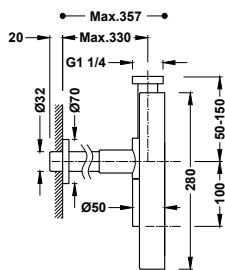

10710342

- 10710342NM
- 10710342BM
- 10710342AC
- 10710342KM
- 10710342KMB
- 10710342OR
- 10710342OM
- 10710342OP
- 10710342OPM

Sifón telescópico redondo inspeccionable con faldón para lavabo

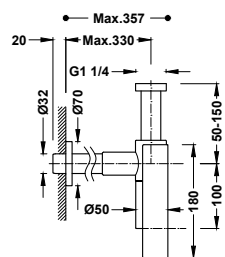

16110342

- 16110342NM
- 16110342BM
- 16110342AC
- 16110342KM
- 16110342KMB
- 16110342OR
- 16110342OM
- 16110342OP
- 16110342OPM

Sifón telescópico tipo botella inspeccionable para lavabo

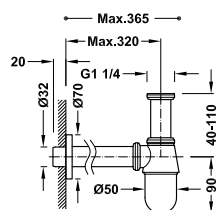

13463430

- 03463430NM
- 03463430BM
- 03463430AC
- 03463430KM
- 03463430KMB
- 03463430OR
- 03463430OM
- 03463430OP
- 03463430OPM
- 03463430LV
- 03463430LM

N
N

Sifón telescópico con registro para lavabo

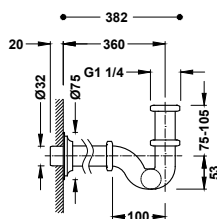

13463820

- 03463820NM
- 03463820BM
- 03463820AC
- 03463820KM
- 03463820KMB
- 03463820OR
- 03463820OM
- 03463820OP
- 03463820OPM
- 03463820LV
- 03463820LM

N
N
N
N

Sifón telescópico acodado para lavabo

16110362

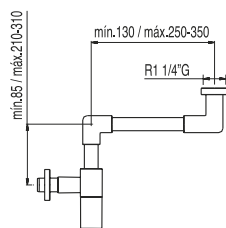

Sifón telescópico para lavabo

16110372

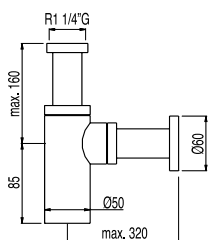

Sifón telescópico para lavabo

13463410

13463410NM

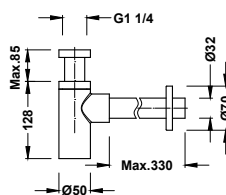

Sifón telescópico para lavabo

13463420

13463420NM

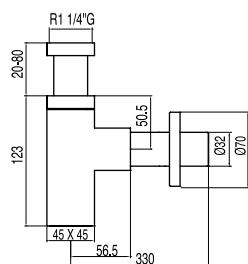

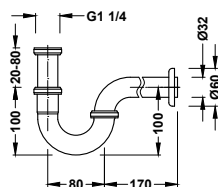

Sifón telescópico giratorio para lavabo

Tubo de salida giratorio. Ideal para cualquier instalación.

13463810

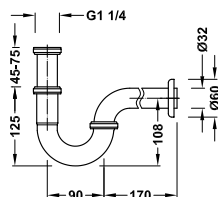
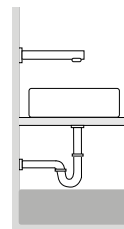

Sifón telescópico giratorio para lavabo

Tubo de salida giratorio. Ideal para cualquier instalación.

134215024

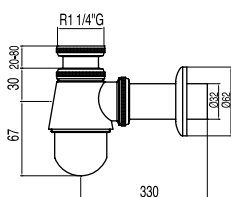
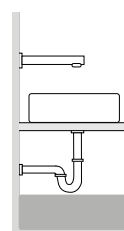

Sifón telescópico tipo botella inspeccionable para bidé

13463440

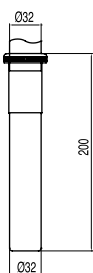
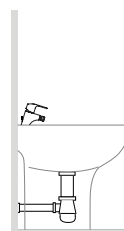

Alargadera para sifón telescópico tipo botella

Longitud: 200 mm.

913463320

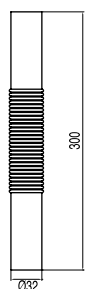
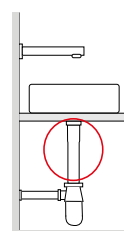

Tubo flexible corrugado para sifón telescópico tipo botella

Longitud: 300 mm.

913463330

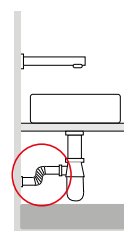

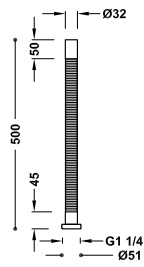

Tubo flexible coarrugado para desagüe

913463250

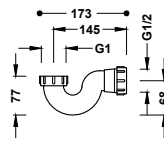
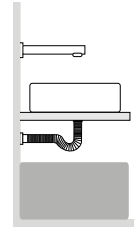

Sifón de PVC para bañera

13463460

LLAVES DE PASO

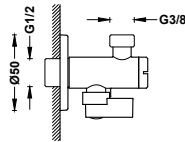

Llave de escuadra con filtro
R.1/2" - R.3/8"

9134525

9134525NM

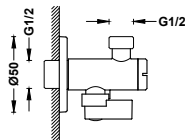
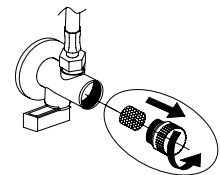

Llave de escuadra con filtro
R.1/2" - R.1/2"

29952505

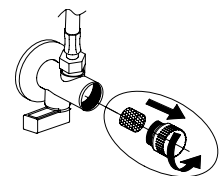

Llave de escuadra

13474220

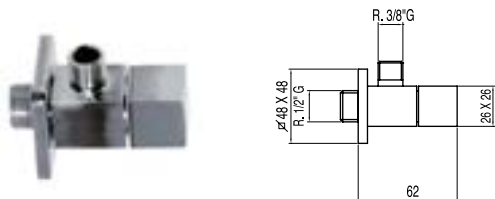

Llave de escuadra

13474210



Llave de paso empotrada

Conexión a rosca hembra: 1/2".

06115501

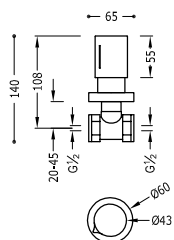

- 06115501NM
- 06115501BM
- 06115501KM
- 06115501KMB
- 06115501OR
- 06115501OM
- 06115501OP
- 06115501OPM



Llave de paso empotrada

Conexión a rosca hembra: 3/4".

06151101

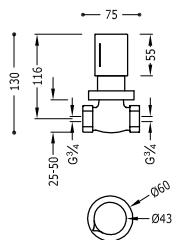

- 06151101NM
- 06151101BM
- 06151101KM
- 06151101KMB
- 06151101OR
- 06151101OM
- 06151101OP
- 06151101OPM



Válvula mezcladora de agua caliente-fría

Apto para hacer llegar agua premezclada a un grifo de 1 agua de lavabo y cocina.

19250730

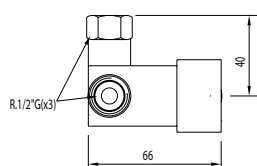

CONEXIONES ACODADAS Y ALARGADERAS

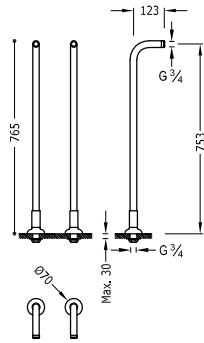

Tomas de agua acodadas de instalación a suelo para grifo de bañera

2 columnas verticales de alimentación de agua a suelo.

24219403

24219403AC

24219403LV

24219403LM

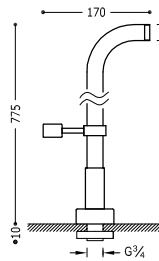

Tomas de agua acodadas de instalación a suelo para grifo de bañera

2 unidades con soporte fijo para ducha de mano.

161194

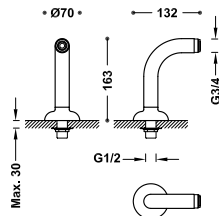

Tomas de agua acodadas de instalación a borde bañera para grifo de bañera

2 unidades con silenciador.

24287101

24287101NM

24287101AC

24287101OR

24287101LV

24287101LM

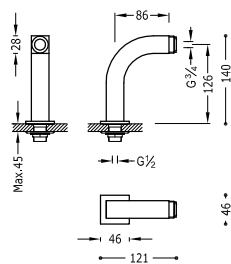

Tomas de agua acodadas de instalación a borde bañera para grifo de bañera

2 unidades con silenciador.

29987002



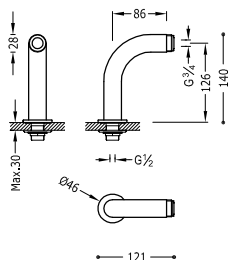

Tomas de agua acodadas de instalación a borde bañera para grifo de bañera
2 unidades con silenciador.

29987001

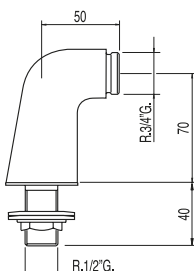

Tomas de agua acodadas de instalación a borde bañera para grifo de bañera
2 unidades con silenciador.

134870

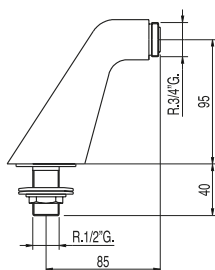

Tomas de agua acodadas de instalación a borde bañera para grifo de bañera
2 unidades con silenciador.

134871

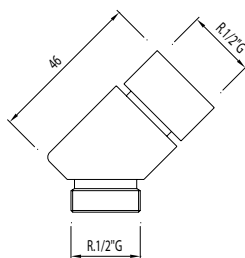

Conexión acodada universal para ducha de mano

Apto para bañeras de repisa. Para ref.: 14150, 61150, 62150, 63145, 61161, 87150, 87161, 89150, 89161.

913414580

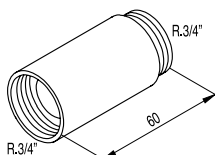

Alargadera para grifería de pared

2 unidades macho-hembra de 6 cm de longitud con silenciador.

9134872

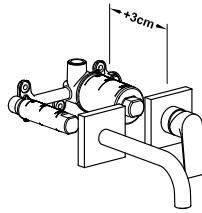

Set de prolongación para los grifos monomando empotrado para lavabo

21830010

Apto para todas las series de Tres, con cuerpo empotrado indivisible con amortiguadores acústicos, excepto la Tres-Classic. Profundidad: 30 mm.

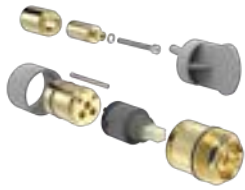

Set de prolongación para los grifos monomando empotrado de 2 vías Rapid-box

29928010

Profundidad: 30 mm.



CAÑOS

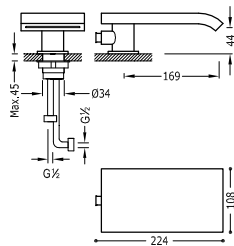

Caño fijo para borde bañera con salida en cascada

16216150

Caño cerrado con salida del agua en cascada. Inversor integrado en el caño.

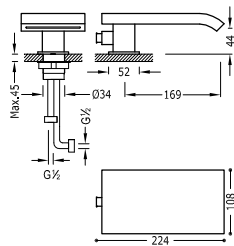

Caño fijo para borde bañera con salida en cascada

18718250

Caño cerrado con salida del agua en cascada. Inversor integrado en el caño.

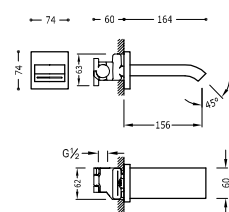

Caño fijo de pared con salida en cascada

107181

Caño cerrado con salida del agua en cascada. Con toma de agua a pared regulable en profundidad. Cuerpo empotrado incluido.



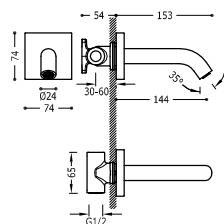

Caño fijo de pared

Con toma de agua a pared regulable en profundidad. Cuerpo empotrado incluido.

21018107

- 21018107NM
- 21018107BM
- 21018107AC
- 21018107KM
- 21018107KMB
- 21018107OR
- 21018107OM
- 21018107OP
- 21018107OPM

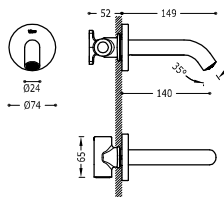

Caño fijo de pared

Con toma de agua a pared regulable en profundidad. Cuerpo empotrado incluido.

26218004

- 26218004NM
- 26218004BM
- 26218004AC
- 26218004KM
- 26218004KMB
- 26218004OR
- 26218004OM
- 26218004OP
- 26218004OPM

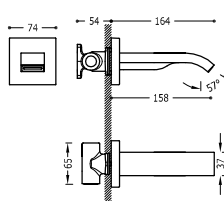

Caño fijo de pared con salida en cascada

Caño cerrado con salida del agua en cascada. Con toma de agua a pared regulable en profundidad. Cuerpo empotrado incluido.

20718107

- 20718107NM
- 20718107BM
- 20718107AC
- 20718107OR
- 20718107OM

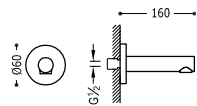

Caño fijo de pared

Con toma de agua roscada G1/2. Longitud: 160 mm. No es un recambio. No es compatible con cuerpos empotrados indivisibles.

16117002

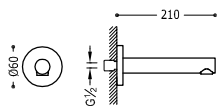

Caño fijo de pared

Con toma de agua roscada G1/2. Longitud: 210 mm. No es un recambio. No es compatible con cuerpos empotrados indivisibles.

06117202

Caño fijo de pared

16117102

Con toma de agua roscada G1/2. Longitud: 250 mm. No es un recambio. No es compatible con cuerpos empotrados indivisibles.



Caño giratorio de pared

134301

Tipo fundido. Longitud: 255 mm.

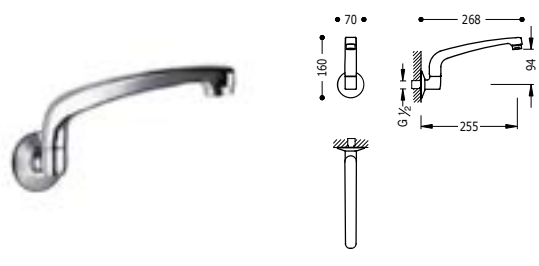

Caño giratorio de pared

134302

Tipo tubo. Longitud: 237 mm.

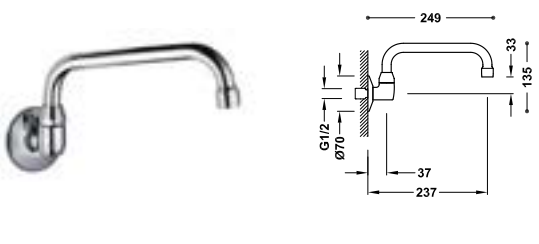

Caño giratorio de pared

134303

Tipo tubo. Longitud: 287 mm.

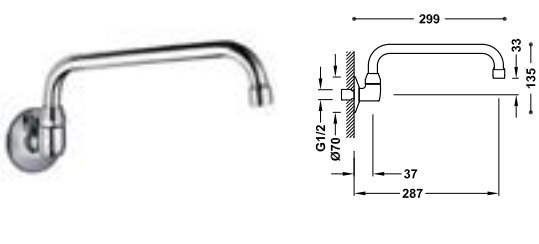

FLORONES

Florón cuadrado

Material: Latón.

913474410

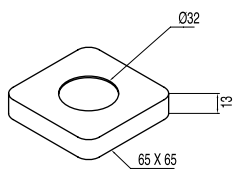

Florón redondo

Material: Latón.

913474430

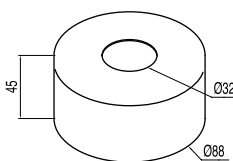

Florón redondo

Material: Latón.

913474420

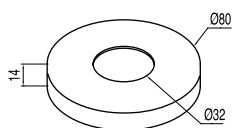

Florón para excéntricas especiales

Material: Latón. Ø 70 mm.

9134781

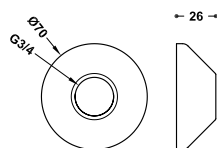

Florón para excéntricas especiales

Material: Latón. Ø 80 mm.

9134784

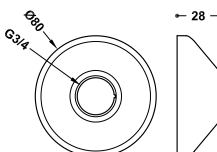

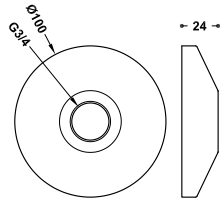

Florón para excéntricas especiales
Material: Latón. Ø 100 mm.

9134788

EXCÉNTRICAS



Excéntrica con silenciador para desplazar la toma de la grifería

9134779

Conexión roscada macho: 1/2". Desplazamiento: 7,5 mm. 13,5 - 16,5 mm.

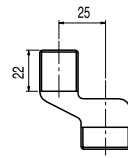

Excéntrica con silenciador para desplazar la toma de la grifería

9134780

Conexión roscada macho: 1/2". Desplazamiento: 25 mm. 10 - 20 mm.

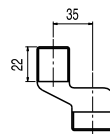

Excéntrica para desplazar la toma de la grifería

9134787

Conexión roscada macho: 1/2". Desplazamiento: 35 mm. 8 - 22 mm.
Compatible con el florón ref.: 9134788

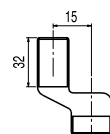

Excéntrica con silenciador para desplazar la toma de la grifería

9134786

Conexión roscada macho: 1/2". Desplazamiento: 15 mm. 12 - 18 mm.



VÁLVULAS DE VACIADO

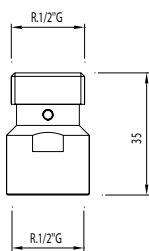

Válvula de vaciado

Funciona con las duchas: 134126, 9134729, 913472906, 9134725, 134821, 134617, 134616, 134924, 9134824, 913482510, 134611. Funciona con los rociadores: 13413825, 13413826, 13413830, 19312310, 13413725, 13413726, 13413730.

913478906

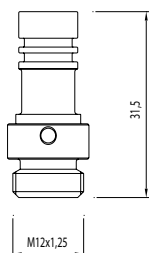

Válvula de vaciado

Para ref.: 07395, 07926, 07131.

913478907

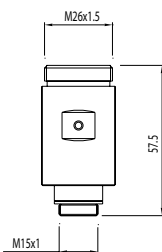

Válvula de vaciado

Para ref.: 81385, 81191. Anterior al año 2012.

913478908

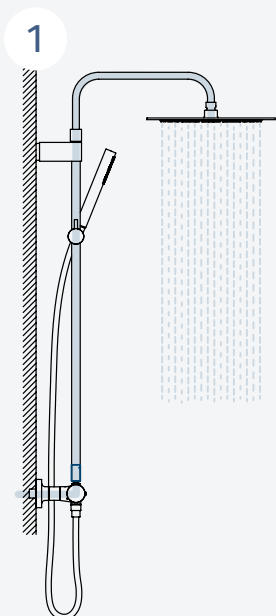

LIMITADOR

Limita el caudal del agua liberando de presión el rociador.

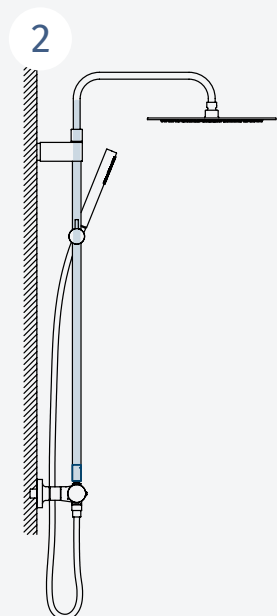

ANTILEGIONELA

Evita la procreación de bacterias como la legionela.

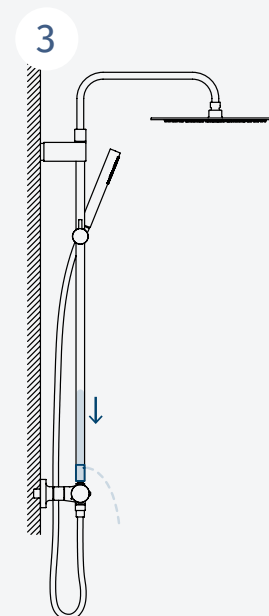

ANTIGOTEO

Una vez finalizada la utilización de la ducha, éste evita el goteo del rociador.

VÁLVULA TERMOSTÁTICA

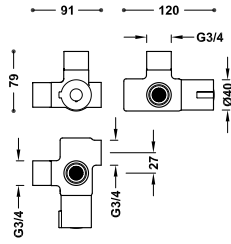

Válvula termostática para el calentador

20725001

- Filtros en las entradas de agua.
- Con válvulas antirretorno en las entradas de agua.
- Ideal para espacios públicos donde queremos temperatura constante.

- Cuerpo de latón.
- Reduce el consumo de energía y agua en circuitos de recirculación.
- Aumenta el volumen de agua caliente ya que a la salida del calentador añadimos agua fría.
- Seguridad: evita quemaduras causadas por el agua caliente.

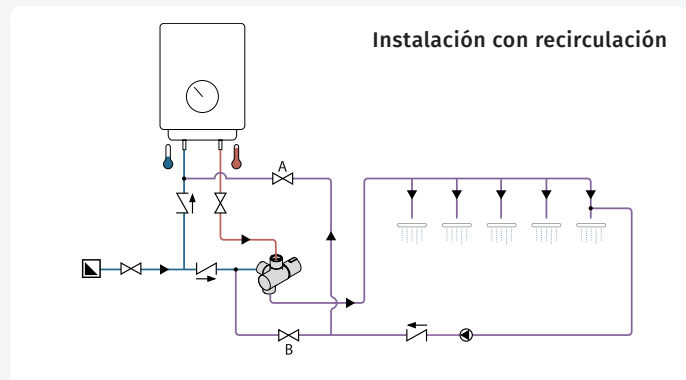
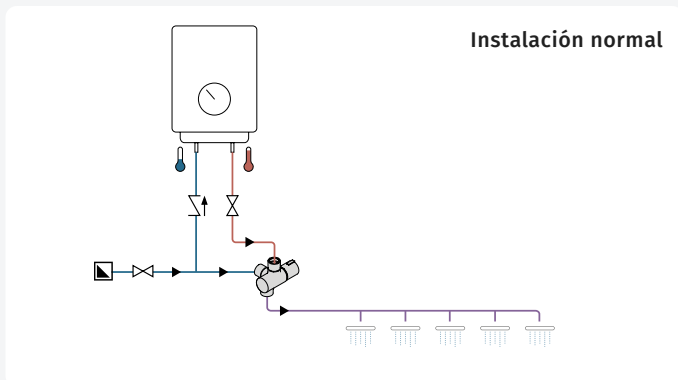

WC SYSTEMS

Tres ofrece mecanismos para la cisterna de wáter como una alternativa económica y de calidad en estos elementos presentes en un cuarto de baño. Distintos mecanismos de llenado y de vaciado con un funcionamiento e instalación similar pero con características particulares para resolver las distintas necesidades de cada tipo de cisterna.





MECANISMOS DE LLENADO

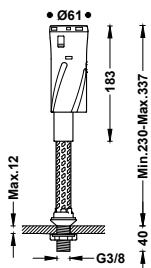

Mecanismo de llenado para cisterna de inodoro

25477001

- Monobloc de llenado inferior.
- Entrada de agua G3/8 con racord de latón.
- Con ajuste de nivel de agua fácil y rápido.
- Con filtro de fácil acceso.
- Extra silencioso. Solo 16 db.
- Llenado rápido: 5,2 l. (5 bars)
- Regulación superior.

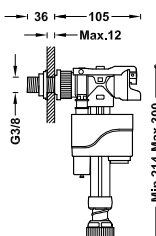

Mecanismo de llenado para cisterna de inodoro

25477007

- De llenado inferior o lateral.
- Entrada de agua lateral o inferior intercambiando el racord de latón.
- Entrada de agua G3/8 racord de latón.
- Filtro en la entrada de agua.
- Con ajuste de nivel de agua fácil y rápido.
- Regulación superior.

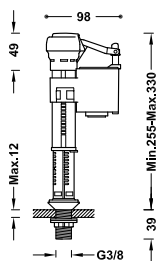

Mecanismo de llenado para cisterna de inodoro

25477002

- De llenado inferior.
- Entrada de agua G3/8 con racord de latón.
- Filtro en la entrada de agua.
- Con ajuste de nivel de agua.
- Regulación superior.

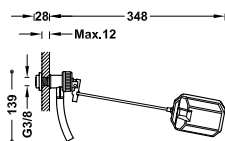

Mecanismo de llenado para cisterna de inodoro

25477004

- De llenado lateral.
- Sujeción de la boya con varilla de latón.
- Entrada de agua G3/8 racord de latón.
- Filtro en la entrada de agua.

Mecanismo de llenado para cisterna de inodoro

25477003

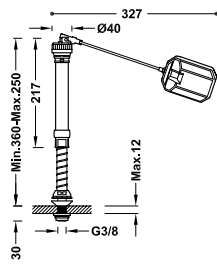

- De llenado inferior.
- Sujeción de la boya con varilla de latón.
- Entrada de agua G3/8 racord de latón.
- Filtro en la entrada de agua.
- Con ajuste de nivel de agua.

MECANISMOS DE DESCARGA

Mecanismo de descarga para cisterna de inodoro

25477012

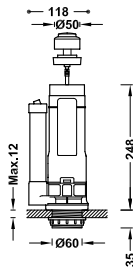

- Descarga única.
- Accionamiento superior.
- Mecanismo universal con pulsador.
- Botón de descarga única.
- Ajuste de la altura del rebosadero.
- Rango de ajuste para la descarga.
- Con junta de silicona.

Mecanismo de descarga para cisterna de inodoro

25477009

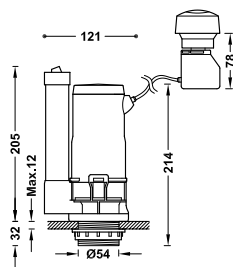

- Doble descarga.
- Accionamiento superior o lateral.
- Mecanismo universal con doble pulsador.
- Botón de descarga total y botón de descarga parcial.
- Ajuste de la altura del rebosadero.
- Con junta de silicona.





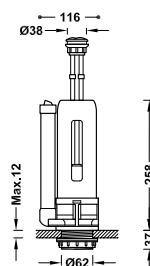

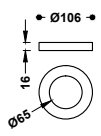

Mecanismo de descarga para cisterna de inodoro

25477005

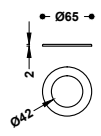

- Doble descarga.
- Accionamiento superior.
- Mecanismo universal con doble pulsador.
- Botón de descarga total y botón de descarga parcial.
- Velocidad de descarga rápida.
- Con junta de silicona.

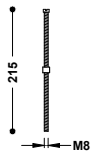

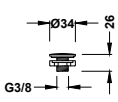
 	<p>Junta de conexión Material: Foam. Dimensiones: 106x65x16 mm.</p>	<p>25477006</p>
 	<p>Junta de silicona Dimensiones: 65x42x2 mm.</p>	<p>25477010</p>
 	<p>Tornillos de fijación de cisterna a inodoro</p>	<p>25477008</p>
 	<p>Varilla roscada 2 unidades</p>	<p>25477011</p>
 	<p>Tapón para la cisterna</p>	<p>25477013</p>

Conjunto completo de mecanismo de llenado para cisterna de inodoro

25477091

- 25477001 - Mecanismos de llenado
- 25477009 - Mecanismos de descarga
- 25477006 - Junta de conexión
- 25477008 - Tornillos de fijación de cisterna
- 25477013 - Tapón para la cisterna



Conjunto completo de mecanismo de llenado para cisterna de inodoro

25477092

- 25477007 - Mecanismos de llenado
- 25477009 - Mecanismos de descarga
- 25477006 - Junta de conexión
- 25477008 - Tornillos de fijación de cisterna
- 25477013 - Tapón para la cisterna



TRES CLEANER

Tres Cleaner es un espray limpiador para grifería de baño y cocina testado para los productos Tres. Doble función para eliminar la suciedad y mantener el acabado de la grifería. El limpiador de grifería funciona pulverizando la zona a lavar, dejándolo actuar brevemente, aclarando con agua tibia y secándolo con un paño suave.





Tres Cleaner

Lo más recomendado para limpiar las superficies metálicas y brillantes de los grifos

- Abrillanta las superficies
- Elimina las huellas
- Repele la suciedad
- Elimina la cal
- Efecto antiestático



Con la boquilla abierta se dispersa el líquido con un pulverizador fino que llega a áreas más grandes, como mamparas y espejos.



Con la boquilla cerrada, la espuma limpiadora activa se adhiere y actúa significativamente más sobre la suciedad y permite una limpieza más profunda.

LIMPIADOR DE GRIFERÍA



Tres Cleaner. Limpiador de grifería para baño y cocina

134100106

- Abrillanta las superficies.
- Elimina las huellas.
- Repele la suciedad.
- Elimina la cal.
- Efecto anti-estático.



Caja de 12 unidades. Tres Cleaner. Limpiador de grifería para baño y cocina

134100106CB12

- Abrillanta las superficies.
- Elimina las huellas.
- Repele la suciedad.
- Elimina la cal.
- Efecto anti-estático.



Conjunto completo para el mantenimiento y limpieza de rociadores y grifería

134100108

Tres Cleaner. Limpiador de grifería para baño y cocina. + Mango telescópico para limpieza.



Caja de 16 unidades. Conjunto completo para el mantenimiento y limpieza de rociadores y grifería

13410010816

Tres Cleaner. Limpiador de grifería para baño y cocina. + Mango telescópico para limpieza.



ANEXO

Instalación recomendada	520
Recambios	524
Listado de referencias	528
Condiciones de venta	540



INSTALACIÓN RECOMENDADA

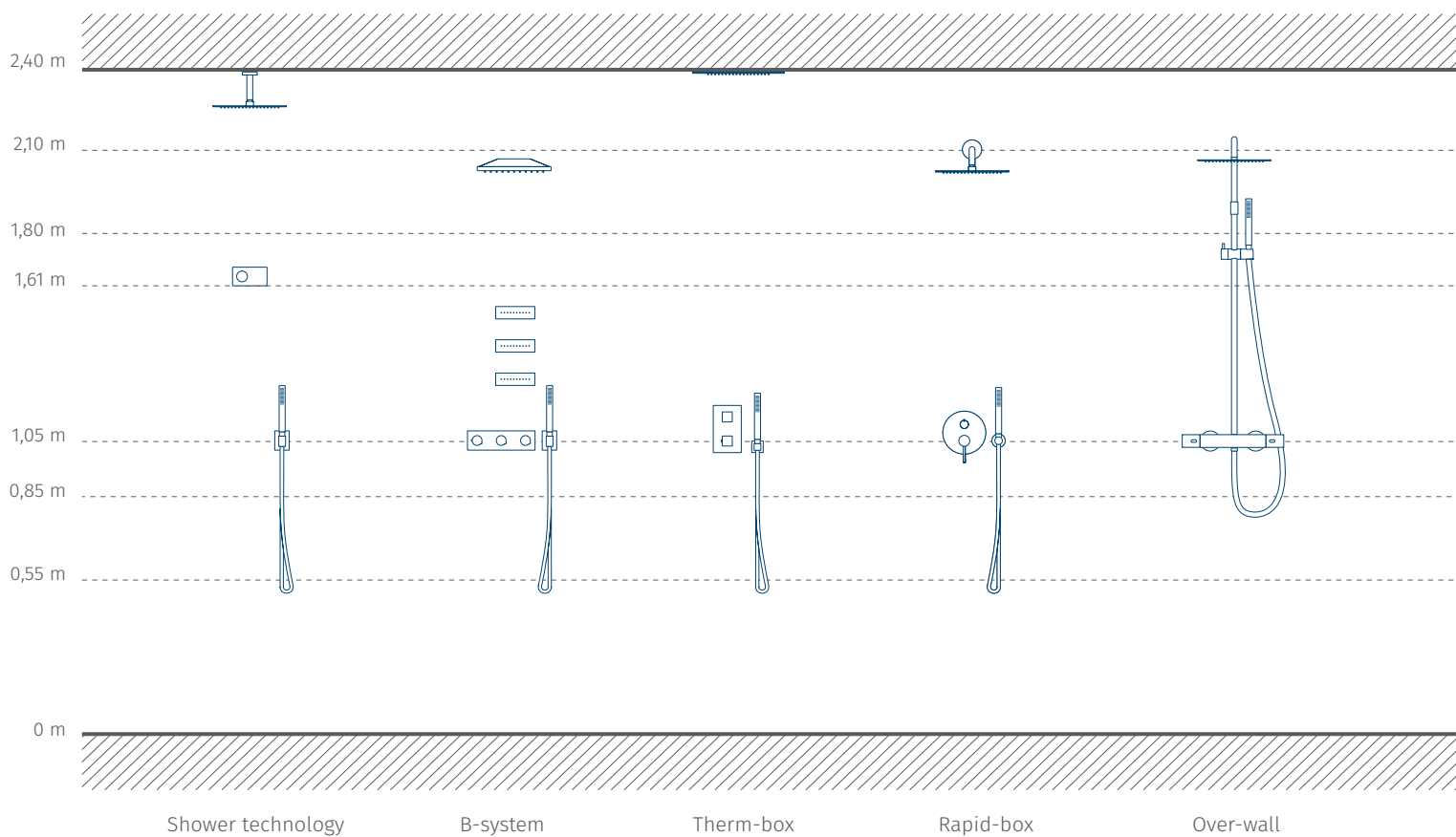



Desagües de ducha o bañera

Se podrán utilizar grifos con 2 salidas de agua al mismo tiempo siempre que el desagüe esté calculado para ello. (Tres recomienda el desagüe ref. 1 04 840)

Suministro de agua

El caudal de cada producto puede necesitar distintas presiones, pero con una presión dinámica de entre 2 y 3 bar sería suficiente. La presión dinámica se mide con el grifo abierto.

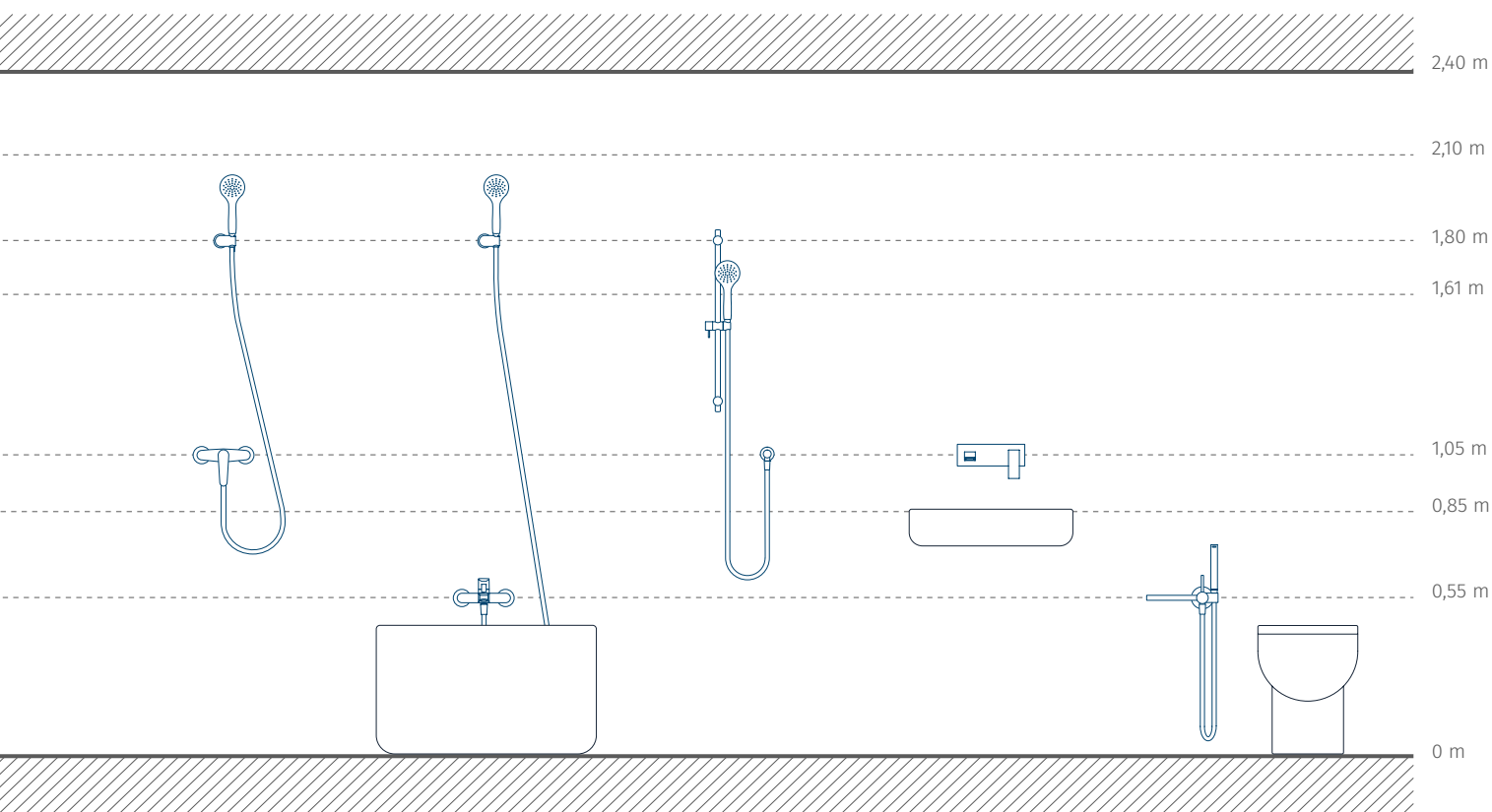



Nuevos diseños de volantes

B-SYSTEM

THERM-BOX

OVER-WALL



Volante cuadrado



Volante cuadrado-redondo



Volante con bordes redondeados

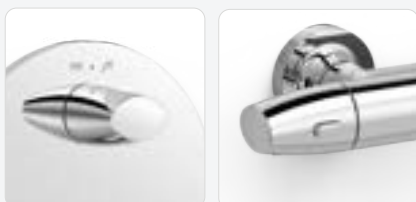

Volante ovalado





































Volante redondo













Volante en cruz



Visite nuestra página web para encontrar más recambios y planos de despiece de la grifería

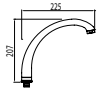
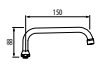
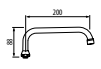
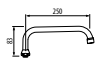
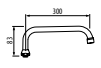
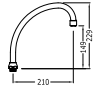





























	Aireador Cascade SLC. 24 Macho	9134673 9134673503 9134673501		Limitador de caudal. 24 Macho. Caudal: 8 l/min.	9134682
	Aireador 18 Macho	9262503		Limitador de caudal. 24 Macho. Caudal: 5 l/min.	91346825
	Aireador Cascade SLC 22 Hembra	9134672 9134672501		Aireador + Casquillo. 24 Macho. Caudal: 5 l/min.	23461305
	Aireador 24 Macho. Retención "C"	29966310		Limitador de caudal. 22 Hembra. Caudal: 6 l/min.	91346816
	Aireador 28 Macho	9134674		Limitador de caudal. 22 Hembra. Caudal: 8 l/min.	9134681
	Aireador oculto rectangular + llave	9106006		Limitador de caudal. 22 Hembra. Caudal: 5 l/min.	91346815
	Aireador enrasado 24 Macho	29961001		Aireador. 22 Hembra + Casquillo. Caudal: 4,5 l/min.	23466205
	Aireador enrasado 16 Macho. Caudal: 8 l/min.	29961002		Aireador enrasado. 24 Macho. Caudal: 4,5 l/min.	23461015
	Aireador 16 Macho. Caudal: 5 l/min.	29961005		Aireador enrasado. 24 Macho. Caudal: 3,8 l/min.	23461013
	Aireador oculto 16,5 Macho + llave	9134665		Rompeaguas enrasado. 24 Macho + Casquillo. Caudal: 1,9 l/min.	23466001
	Aireador oculto 16,5 Macho + llave	9134666		Aireador enrasado. 16,5 Macho. Caudal: 4,5 l/min.	23461050
	Rompeaguas enrasado. 24 Macho + llave	9134668		Aireador enrasado. 24 Macho. Caudal: 4,5 l/min.	23444005
	Rompeaguas enrasado y orientable. 24 Macho. + llave	29961006		Aireador enrasado. 24 Macho. Caudal: 3,8 l/min.	23461303
	Rótula bidé completa 16,5 + llave	9107672		Aireador enrasado. 24 Macho. Caudal: 1,9 l/min.	23461301
	Rótula 22 + Aireador	9134577		Aireador. 22 Hembra + Casquillo. Caudal: 3,8 l/min.	23466203
	Rótula 24 + Aireador	9134677		Aireador enrasado. 16,5 Macho. Caudal: 4,5 l/min.	23461501
	Limitador de caudal. 24 Macho. Caudal: 6 l/min.	91346826		Aireador enrasado. 16,5 Macho. Caudal: 3,8 l/min.	23461380























	Aireador sin casquillo. 17. Caudal: 4,5 l/min.	23466905
	Aireador sin casquillo. 17. Caudal: 3,8 l/min.	23466938
	Aireador sin casquillo. 21. Caudal: 4,5 l/min.	23467205
	Aireador sin casquillo. 21. Caudal: 3,8 l/min.	23467238
	Aireador enrasado. 18,5 Macho. Caudal: 3,8 l/min.	23461038
	Limitador de caudal para flexo 1/2" Macho-hembra. Caudal: 8 l/min.	9134683
	Limitador de caudal para flexo 1/2" Macho-hembra. Caudal: 7,5 l/min.	23468301
	Limitador de caudal para flexo 1/2" Macho-hembra. Caudal: 6 l/min.	23468303
	Caño fijo para borde bañera sin distribuidor	913214591
	Caño para grifería de cocina Ø 28 mm.	9174441
	Caño tubo 15 cm. R3/4"	9134314
	Caño tubo 20 cm. R3/4"	9134315
	Caño tubo 25 cm. R3/4"	9134316
	Caño tubo 30 cm. R3/4"	9134319
	Caño tubo para grifo de cocina R3/4"	9134441
	Ducha extraíble para grifo de cocina. 2 tipos de chorro. R1/2"	9134880
	Ducha extraíble para grifo de cocina. 2 tipos de chorro. R1/2"	9134849

	Ducha extraíble para grifo de cocina. 2 tipos de chorro. R1/2"	913043810
	Ducha para grifo de cocina R1/2"	9134481
	Ducha para grifo de cocina. 2 tipos de chorro. R1/2"	913049310
	Pistón	9133317
	Cartucho Mono-term salida libre Ø 40 mm.	29919505
	Cartucho salida libre Ø 25 mm. + Limitador 5,5 l/min.	29919001
	Cartucho salida libre Ø 25 mm.	9130190
	Cartucho salida fija Ø 25 mm.	910719005
	Cartucho salida fija Ø 35 mm.	9134591
	Cartucho salida libre Ø 35 mm.	9134592
	Cartucho salida fija Ø 40 mm.	9134288
	Cartucho salida libre Ø 40 mm.	9134290
	Cartucho distribuidor 2 vías empotrado. Salida fija Ø 35 mm.	9134235
	Cartucho distribuidor 2 vías termostáticas. Salida libre Ø 35 mm.	9194283
	Cartucho termostático con regulador de caudal - Compact	9194552
	Cartucho termostático Instant 57	29916901
	Cartucho termostático Instant 77	29916902



RECAMBIOS

	Inversor 2 vías monomando 180	916218005		Montura cerámica izquierda (Hot) Retro-tres	913427210
	Inversor 2 vías monomando 180	29955304		Tubo flexible Macho 8x1 - R3/8" Long. 600 mm.	29908405
	Inversor 2 vías monomando 180	910618020		Tubo flexible Macho 8x1 - R3/8" Long. 450 mm.	29908406
	Inversor 2 vías Mono-term	29955303		Tubo flexible Macho 9x1 Long. 370 mm.	9134803
	Inversor automático bañera mural	9134256		Tubo flexible Macho 10x1 - R3/8" Long. 370 mm.	9134806
	Inversor automático bañera mural	9134250		Conjunto varilla y pulsador	913484007
	Inversor automático bañera mural - Essential	29955306		Desagüe automático + Varilla	913484057
	Montura R1/2" Llave de paso ESE-23	9134286		Desagüe automático + Varilla	913427510
	Montura R1/2" Llave de paso	9134296		Tapón para válvula de desagüe automático. Tapón: Ø 63 mm.	913484026
	Montura R1/2" Standard	9134284		Tapón para válvula de desagüe automático	913484016
	Montura R1/2"	9134294		Unión de las varillas para válvula de desagüe automático	913484005
	Montura cerámica R1/2"	9134282		Varilla larga horizontal para válvula de desagüe automático	9134840061
	Montura cerámica R1/2" Eje corto	9134292		Base soporte para grifo de cocina	963033331
	Montura cerámica R1/2" Eje largo	9134293		Conjunto bloqueo 6x1 Macho Long. 120 mm.	919260634
	Montura R3/8"	9134283		Conjunto bloqueo 8x1 Macho Long. 110 mm.	966110301
	Montura cerámica 16 Macho	9162292		Conjunto bloqueo 8x1 Macho Long. 250 mm.	916184010
	Montura cerámica derecha (Cold) Retro-tres	913427220		Conjunto bloqueo 8x1 Macho Long. 70 mm.	913010334

	9133317031 Tornillo fijación caño fundido y caño de tubo. 6x1 Macho		29989601 Llave multiusos + suplemento cartucho Mono-term
	913331703 Tornillo fijación caño fundido y caño de tubo. 6x1 Macho. Pack 10 unidades		29919607 Casquillo caño tubo
	913400831 Tornillo fijación palanca monomando. 5 Macho. Pack 10 unidades		919416401 Filtro termostática
	913400831 Tornillo fijación palanca monomando. 5 Macho		9534294501 Junta tórica NBR 17,17x1,78 mm.
	932010331 Tapón soporte de cadena		9533315501 Junta tórica NBR 70SH 18x2,2 mm.
	9134882 Bote de grasa		953331550 Junta tórica NBR 70SH 18x2,2 mm. Pack 10 unidades
	9134895 Llave aireador oculto 16,5 Macho		9530440521 Junta tórica NBR 70SH 41x2,5 mm.
	9134896 Llave aireador oculto 18,5 Macho		953044052 Juntas tóricas NBR 70SH 41x2,5 mm. Pack 10 unidades
	9134897 Llave aireador oculto 24 Macho		9533317501 Junta tórica EPDM 70SH 18,72x2,62 mm.
	9134898 Llave aireador oculto rectangular		953331750 Juntas tóricas EPDM 70SH 18,72x2,62 mm. Pack 10 unidades
	9134891 Llave aireadores		
	299392134 Regulador del sensor para grifería electrónica		
	919210318 Llave allen 2,5 mm.		
	9134893 Llave bloqueo tuerca		
	29989603 Llave distribuidor monomando empotrado		
	9134890 Llave multiusos		
	29989602 Llave multiusos + suplemento cartucho Loft		



REFERENCIA	Pág.	REFERENCIA	Pág.	REFERENCIA	Pág.	REFERENCIA	Pág.	REFERENCIA	Pág.
00		00620101OM	76	00628006	319	00661002	75	030336AC	446
00610101	75	00620101OR	76	00628006AC	85	00663901	381	030336BM	446
00610101AC	75	00620501AC	77	00628006AC	319	00663901AC	381	03035501	459
00610101BL	75	00620501BM	77	00628006BM	85	00663901BM	381	03043401	461
00610101BM	75	00620501NM	77	00628006NM	319	00663901KMB	381	03043801	462
00610101D	75	00620501OM	77	00628006NM	85	00663901NM	381	03044401	461
00610101NE	75	00620501OR	77	00628006NM	319	00663901OM	381	03045501	459
00610101NM	75	00625001	256	00628006OM	85	00663901OP	381	03048501	467
00610101OM	75	00625001AC	256	00628006OM	319	00663901OPM	381	03048701	457
00610101OR	75	00625001BM	256	00628006OR	85	00663901OR	381	03049301	467
00610102	75	00625001NM	256	00628006OR	319	00681001	76	030496BM	444
00610102D	75	00625001OM	256	00630001	79	00681001AC	76	030496NM	444
00611001	76	00625001OR	256	00630001AC	79	00681001BL	76	030496OM	444
00611001BL	76	00625003	90	00630001BM	79	00681001BM	76	030497BM	444
00611001D	76	00625003AC	90	00630001NM	79	00681001NE	76	030497NM	444
00611001NE	76	00625003AC	263	00630001OM	79	00681001NM	76	030497OM	444
00611002	76	00625003BM	90	00630001OR	79	00681001OM	76	030498BM	444
00611002BL	76	00625003NM	263	00630002	79	00681001OR	76	030498NM	444
00611002D	76	00625003OM	90	00630002AC	79	00681002	75	030498OM	444
00611002NE	76	00625003OR	90	00630002BM	79	00698003	86	03411601	381
00612001	80	00625003OR	263	00630002NM	79	00698003	328	03411601AC	381
00612001AC	80	00625004	259	00630002NM	79	00712001	80	03411601AC	381
00612001BL	80	00625004AC	90	00630002OM	79	00712001AC	80	03411601BM	381
00612001BM	80	00625004AC	259	00630002OR	79	00712001BL	80	03411601KMB	381
00612001D	80	00625004AC	90	00630003	79	00712001BM	80	03411601KMB	381
00612001NE	80	00625004BM	90	00630003AC	79	00712001NM	80	03411601NM	381
00612001NM	80	00625004BM	259	00630003BM	79	00712001D	80	03411601OM	381
00612001OM	80	00625004BM	90	00630003NM	79	00712001NE	80	03411601OP	381
00612001OR	80	00625004BM	259	00630003OM	79	00712001NM	80	03411601OPM	381
00612301	81	00625004BM	90	00630003OR	79	00712001OM	80	03411601OPM	381
00612301AC	81	00625004NM	90	00630003OR	79	00712001OR	80	03411601OR	381
00612301BM	81	00625004NM	259	00630011	78	00712001OR	80	03412102	367
00612301NM	81	00625004OM	90	00630011AC	78	00715501	91	03412401	152
00612301OM	81	00625004OM	259	00630011BM	78	00715501AC	91	03412401	100
00612301OR	81	00625004OR	90	00630011NM	78	00715501BM	91	03412401	138
00612302	81	00625005AC	265	00630011OM	78	00715501NM	91	03412401	64
00612302AC	81	00625005AC	265	00630011OR	78	00715501OM	91	03412401AC	100
00612302BM	81	00625005AC	265	00630012	79	00715501OR	91	03412401AC	64
00612302NM	81	00625005BM	265	00630012AC	79	00716703BM	81	03412401AC	100
00612402AC	80	00625005NM	265	00630012BM	79	00716703NM	81	03412401BM	64
00612402BM	80	00625005NM	265	00630012NM	79	00716703OM	81	03412401BM	64
00612402NM	80	00625005OM	265	00630012OM	79	00716703OR	81	03412401KMB	64
00612402OM	80	00625005OM	265	00630012OR	79	0071700203BM	81	03412401KMB	100
00612402OR	80	00625006AC	268	00630013	79	0071700203NM	81	03412401NM	64
00613001	80	00625006AC	268	00630013AC	79	0071700203NM	81	03412401NM	64
00613001AC	80	00625006BM	268	00630013AC	79	0071700203OM	81	03412401OM	100
00613001BM	80	00625006NM	268	00630013BM	79	0071700203OR	81	03412401OM	64
00613001NM	80	00625006NM	268	00630013NM	79	00719101	82	03412401OP	64
00613001OM	80	00625006OM	268	00630013OM	79	00719101	338	03412401OPM	64
00613001OR	80	00625006OM	268	00630013OR	79	00719102	82	03412401OPM	64
00616103	349	00628003AC	84	006437BM	460	00719102	338	03412401OR	64
00616103AC	88	00628003AC	313	006437NM	460	00719701	83	03412401OR	64
00616103AC	349	00628003BM	84	006437OM	460	00719701	339	03412402AC	81
00616103AC	88	00628003BM	313	00648501	77	00719701	83	03412402AC	81
00616103BM	349	00628003NM	84	00648501AC	77	00719702	339	03412402BM	81
00616103BM	88	00628003NM	313	00648501BM	77	00719702	82	03412402BM	81
00616103NM	349	00628003OM	84	00648501NM	77	00719702	339	03412402NM	81
00616103NM	88	00628003OR	84	00648501OM	77	00750301AC	78	03412402NM	81
00616103OM	349	00628003OR	313	00648501OR	77	00750301BM	78	03412402OR	81
00616103OM	88	00628004	84	006486BM	444	00750301NM	78	03423101	370
00616103OR	349	00628004AC	84	006486NM	444	00750301OM	78	03433603	395
00616103OR	88	00628004AC	309	006486OM	444	00750301OR	78	03433604	395
00616104	348	00628004AC	84	00648701	457	01210002	473	03443101	370
00616104	87	00628004AC	309	00648701AC	457	01210003	473	03443202	366
00616105	349	00628004BM	84	00648701BM	457	01210302	472	03443203	366
00616105	87	00628004BM	309	00648701NM	457	01210303	472	03450101	481
00616105AC	349	00628004NM	84	00660502AC	78	01210303	472	03450102	481
00616105AC	87	00628004NM	309	00660502BM	78	01210303	472	03452602	394
00616105BM	349	00628004OM	84	00660502NM	78	01217901	476	03452702	394
00616105BM	87	00628004OM	309	00660502NM	78	01220002	474	03453420AC	491
00616105NM	349	00628004OR	84	00660602AC	78	01220702	436	03453420BM	491
00616105NM	87	00628004OR	309	00660602BM	78	01220801	474	03453420NM	491
00616105OM	349	00628005	84	00660602NM	78	01221701	436	03453420OM	491
00616105OM	87	00628005AC	316	00660602OM	78	01240801	435	03453420OPM	491
00616105OR	349	00628005AC	84	00660602OR	78	01240850	435	03453420LMB	491
00616106	348	00628005BM	84	00660602OR	78	01299601	480	03453420LMB	491
00616106	87	00628005BM	316	00660702AC	78	01		03453420NM	491
00618080	86	00628005NM	84	00660702BM	78	02351501	224	03453420OPM	491
00618080	332	00628005NM	316	00661001	75	02352001C	223	03453420OR	491
00618301	407	00628005OM	84	00661001AC	75	02352001F	223	03453430AC	491
00620101	76	00628005OM	316	00661001BL	75	02418201	407	03453430BM	491
00620101AC	76	00628005OR	84	00661001NM	75	02463609AC	416	03453430KMB	491
00620101BM	76	00628005OR	316	00661001OM	75	02463609LM	416	03453430KMB	491
00620101NM	76	00628006	85	00661001OR	75	02463609OR	416	03453430LMB	491
						02		03453430LMB	491
						02351501	224	03453430NM	491
						02352001C	223	03453430OM	491
						02352001F	223	03453430OPM	491
						02418201	407	03453430OPM	491
						02463609AC	416	03453430OR	491
						02463609LM	416	03453430OR	491
						02463609OR	416		
						03			
						030335AC	462		
						030335BM	462		
						030335NM	462		
						030335OM	462		

REFERENCIA	Pág.	REFERENCIA	Pág.	REFERENCIA	Pág.	REFERENCIA	Pág.	REFERENCIA	Pág.
03453440AC	492	03474601LM	490	06122001D	137	06228004	139	09226301LV	38
03453440NM	492	03474601OM	490	06144701	432	06228004	311	09226301OR	38
03453440OM	492	03474601OR	490	06144701	135	06228005	140	09226302	38
03453440OR	492	03483102	367	06144801	433	06228005	318	09226302AC	38
03463430AC	494	03493101	397	06144801	135	06228006	140	09226302LM	38
03463430BM	494	03493101AC	397	06151101	498	06228006	320	09226302LV	38
03463430KM	494	03493101BM	397	06151101	179	06228110	139	09226302OR	38
03463430KMB	494	03493101NM	397	06151101	159	06228110	307	09244501AC	468
03463430LM	494	03493199	394	06151101	105	06230001	136	09244501AC	437
03463430LV	494	03493199AC	394	06151101	145	06230002	136	09244601	468
03463430NM	494	03493199BM	394	06151101BM	498	06230011	136	09244601	437
03463430OM	494	03493199NM	394	06151101BM	105	06230012	136	09286302	426
03463430OP	494	03493201	397	06151101KM	498	06243201	378	09286302	238
03463430OPM	494	03493201AC	397	06151101KMB	498	06243201AC	378	09286304	427
03463430OR	494	03493201BM	397	06151101NM	498	06243201BM	378	09286304	239
03463501	279	03493201NM	397	06151101NM	105	06243201KM	378	09286307	426
03463501AC	279	03493299	394	06151101OM	498	06243201KMB	378	09286307	238
03463501BM	279	03493299AC	394	06151101OM	105	06243201NM	378	09286308	426
03463501KMB	279	03493299BM	394	06151101OP	498	06243201NM	378	09286308	238
03463501NM	279	03493299NM	394	06151101OPM	498	06243201OP	378	09286308OM	426
03463501OM	279	03944401	461	06151101OR	498	06243201OPM	378	09286308OM	238
03463501OPM	279			06151101OR	105	06243201OR	378	09286308OPM	426
03463502	279	06		06163504	401	062435AC	445	09286308OPM	238
03463502AC	279	06110301	133	06163505	401	062435BM	445	09286315	427
03463502BM	279	06110301D	133	06163506	402	062435NM	445	09286315	239
03463502KMB	279	06110302	134	06163509	403	062435OM	445	09286402	428
03463502NM	279	06110302D	134	06183901AC	404	06243601AC	446	09286402	240
03463502OM	279	06110501	60	06183901BM	404	06243601BM	446	09286404	428
03463502OPM	279	06110501AC	60	06183901KM	404	06243601NM	446	09286404	240
03463505	280	06110501BM	60	06183901KMB	404	06243601OM	446	09286408	428
03463505AC	280	06110501KM	60	06183901NM	404	06248702	457	09286408	240
03463505BM	280	06110501KMB	60	06183901OM	404	06248801	445	09286551	422
03463505KMB	280	06110501NM	60	06183901OPM	404	06250301	218	09286551	234
03463505NM	280	06110501OM	60	06183901OR	404	06254201	447	09286551OM	422
03463505OM	280	06110501OP	60	06192801	396	06254201AC	447	09286551OM	234
03463505OPM	280	06110501OPM	60	06193102	398	06254201BM	447	09286551OPM	422
03463506	280	06110501OR	60	06193103	397	06254201NM	447	09286551OPM	234
03463506AC	280	06110502	60	06193104	398	06254201OM	447	09286552	424
03463506BM	280	06110502AC	60	06193105	398	06260301	219	09286552	236
03463506KMB	280	06110502BM	60	06210301	133	06298001	330	09286555	425
03463506NM	280	06110502KM	60	06210301D	133	06298001	142	09286555	237
03463506OM	280	06110502KMB	60	06210302	134	06298004	330	09286556	425
03463506OPM	280	06110502NM	60	06210302D	134	06298004	141	09286556	237
03463701	391	06110502OM	60	06212001	137	06944001	449	09286557	424
03463701AC	391	06110502OP	60	06212001AC	63	06944401	461	09286557	236
03463701BM	391	06110502OPM	60	06212001BM	63	06944701	450	09286558	422
03463701NM	391	06110502OR	60	06212001D	137			09286558	234
03463702	392	06112001	137	06212001KM	63	07		09286558OM	422
03463706	393	06112001AC	63	06212001KMB	63	07032003	454	09286558OM	234
03463708	392	06112001BM	63	06212001NM	63	07044802	452	09286558OPM	422
03463820AC	494	06112001D	137	06212001OM	63	07099501	480	09286558OPM	234
03463820BM	494	06112001KM	63	06212001OP	63	08		09286561	424
03463820KM	494	06112001KMB	63	06212001OPM	63			09286561	236
03463820KMB	494	06112001NM	63	06212001OR	63	081192	154	09286562	423
03463820LM	494	06112001OM	63	06212001TAM	63	081192	341	09286562	235
03463820LV	494	06112001OP	63	06212001TRO	63	08119301	155	09286563	422
03463820NM	494	06112001OPM	63	06213001	137	08119301	342	09286563	234
03463820OM	494	06112001OR	63	06216102	352	08119302	155	09286563OM	422
03463820OP	494	06112001TAM	63	06216102	143	08119302	342	09286563OM	234
03463820OPM	494	06112001TRO	63	06216103	352	08119701	156	09286563OPM	422
03463820OR	494	06115501	498	06217702	143	08119701	343	09286563OPM	234
03463901	381	06115501	179	06217702	325	08119702	154	09286564	423
03463901AC	381	06115501	159	06217702	141	08119702	341	09286564	235
03463901BL	381	06115501	105	06218002	327	08119703	153	09286564OM	423
03463901BM	381	06115501	145	06218002	141	08119703	340	09286564OM	235
03463901KMB	381	06115501BM	498	06218080	333	08119704	155	09286564OPM	423
03463901NE	381	06115501BM	105	06218080	142	08119704	342	09286564OPM	235
03463901NM	381	06115501KM	498	06218081	333	08120001	150	09286567	423
03463901OM	381	06115501KMB	498	06218081	142	08120021	151	09286567	235
03463901OP	381	06115501NM	498	06220301	133	08333301	451	09286567OM	423
03463901OPM	381	06115501NM	105	06220301D	133			09286567OM	235
03463901OR	381	06115501OM	498	06220304	134	09		09286567OPM	423
03464501	280	06115501OM	105	06220601	134			09286567OPM	235
03464501AC	280	06115501OP	498	06222001	137	09217101	432	09286567OPM	426
03464501BM	280	06115501OPM	498	06222001D	137	09226201	37	09288308NM	238
03464501KMB	280	06115501OR	498	06225001	257	09226201AC	37	09288315NM	427
03464501NM	280	06115501OR	105	06225003	144	09226201LM	37	09288315NM	239
03464501OM	280	06116701	138	06225003	264	09226201LV	37	09288404NM	428
03464501OPM	280	06117001	138	06225004	145	09226201OR	37	09288404NM	240
03474501	493	06117202	502	06225004	260	09226202AC	37	09288408NM	428
03474501AC	493	06118301	408	06225005	267	09226202LM	37	09288408NM	240
03474501LM	493	06120301	133	06225006	269	09226202LV	37	09288551NM	422
03474501OM	493	06120301D	133	06227810	139	09226202OR	37	09288551NM	234
03474501OR	493	06120304	134	06227810	304	09226301	38	09288552NM	424
03474601	490	06120601	133	06228003	140	09226301AC	38	09288552NM	236
03474601AC	490	06122001	137	06228003	315	09226301LM	38	09288555NM	425

REFERENCIA	Pág.	REFERENCIA	Pág.	REFERENCIA	Pág.	REFERENCIA	Pág.	REFERENCIA	Pág.
09288555NM	237	107181	501	123215	464	13413730	375	134315010OR	375
09288556NM	425	10723601	414	123217	465	13413730AC	375	134315011	373
09288556NM	237	10723601AC	414	123230	464	13413730BM	375	134315012	373
09288557NM	424	10723601BM	414	123306	469	13413730KM	375	134315012AC	373
09288557NM	236	10723601KM	414	123310	463	13413730KMB	375	134315012BM	373
09288558NM	422	10723601KMB	414	123314	464	13413730NM	375	134315012KM	373
09288558NM	234	10723601NM	414	123315	464	13413730OM	375	134315012KMB	373
09288561NM	424	10723601OM	414	123317	465	13413730OP	375	134315012NM	373
09288561NM	236	10723601OP	414	123330	465	13413730OPM	375	134315012OM	373
09288563NM	422	10723601OPM	414	123342	463	13413730OR	375	134315012OP	373
09288563NM	234	10723601OR	414	123360	465	13413826	374	134315012OPM	373
09288564NM	423	10723603	414	123416	465	13413830	373	134315012OR	373
09288564NM	235	10723603AC	414	123500C	223	13413830AC	373	134315014	372
09288567NM	423	10723603BM	414	123500F	223	13413830BM	373	134315015	374
09288567NM	235	10723603KM	414	123505	469	13413830KM	373	13431513	376
	10	10723603KMB	414	123506	469	13413830KMB	373	134331	367
104840	492	10723603NM	414	123510C	222	13413830NM	373	13434010	485
104841	493	10723603OM	414	123510F	222	13413830OM	373	13434020	489
106103	77	10723603OP	414	123511C	224	13413830OP	373	13434120	487
106103DA	77	10723603OPM	414	123511F	224	13413830OPM	373	134432	381
106124	80	10723603OR	414	123512C	224	13413830OR	373	134433	370
10616102	349	10723606	414	123512F	224	13413940	377	134445	353
10616102	88	10723606AC	414	123513C	225	13413940AC	377	134512	395
106177	85	10723606BM	414	123513F	225	13413940BM	377	13451501	409
106177	324	10723606KMB	414	123515	224	13413940NM	377	13451501AC	409
10617710	85	10723606NM	414	123520C	223	13413940OM	377	13451501BM	409
10617710	324	10723606NM	414	123520F	223	13413940OR	377	13451501KM	409
106180	85	10723606OM	414	12423601	416	13416703	477	13451501KMB	409
106180	326	10723606OP	414	12423601AC	416	13416803	477	13451501NM	409
10618010	85	10723606OPM	414	12423601LM	416	134184	415	13451501OM	409
10618010	326	10723606OR	414	12423601LV	416	134184AC	415	13451501OP	409
10620501	77	10723620	414	12423601OR	416	134184BM	415	13451501OPM	409
106245	353	10723620AC	414	12423603	416	134184KM	415	13451501OR	409
106245	88	10723620BM	414	12423603AC	416	134184KMB	415	134516	390
10627810	83	10723620KM	414	12423603LM	416	134184NM	415	134517	390
10627810	302	10723620KMB	414	12423603LV	416	134184OM	415	134520	390
10627810AC	83	10723620NM	414	12423603OR	416	134184OP	415	13452102	379
10627810AC	302	10723620OM	414	12423606	416	134184OPM	415	13452102AC	379
10627810BM	83	10723620OP	414	12423606AC	416	134184OPM	415	13452102BM	379
10627810BM	302	10723620OPM	414	12423606LM	416	13420503	475	13452102KM	379
10627810NM	83	10723620OR	414	12423606LV	416	134215023	405	13452102KMB	379
10627810NM	302	107476	400	12423606OR	416	134215024	496	13452102NM	379
10627810OM	83	107503	78	12423607	416	134215025	489	13452102OM	379
10627810OM	302	107511	91	12423607AC	416	134215026	488	13452102OP	379
10627810OR	83	107839	404	12423607LM	416	134215027	493	13452102OPM	379
10627810OR	302	107839BM	404	12423607LV	416	134215028	488	13452102OR	379
10628110	83	107839NM	404	12423607OR	416	134221	367	134522	395
10628110	306	107839OM	404	12463609	416	134232	371	13452202	379
10628110AC	83	107839OR	404			134233	370	13452202AC	379
10628110AC	306	107922	390	13		13424010	487	13452202BM	379
10628110BM	83	107926	399	130335	462	13424020	487	13452202NM	379
10628110BM	306	107935	391	130336	446	13424030	487	13452202OM	379
10628110NM	83	107940	485	130337	453	134301	503	13452202OR	379
10628110NM	306			130481	466	134302	503	13453410	492
10628110OM	83	112100	473	130484	466	134303	503	13453420	491
10628110OM	306	112103	473	130495	466	134315001	376	13453430	491
10628110OR	83	112161	475	130496	444	134315002	374	13453440	492
10628110OR	306	11216150	476	130497	444	134315003	375	13454010	485
106437	460	112162	476	130498	444	134315004	373	13454030	487
106440	444	112163	475	13315510C	225	134315005	375	13454050	486
106486	444	112167	475	13315510F	225	134315006	373	13454060	486
106603	77	112177	476	13315710C	225	134315007	372	13454070	486
106604	77	112178	476	13315710F	225	134315007AC	372	13454110	488
106605	78	112200	474	133516	225	134315007BM	372	13454160	488
106606	78	112205	474	133517	225	134315007KMB	372	13454190	488
106607	78	112206	436	134100106	517	134315007NM	372	134612	384
106980	86	112370	467	134100106CB12	517	134315007OM	372	134617	385
106980	328	112441	467	134100108	517	134315007OP	372	134618	391
107103	76	114444	461	13410010816	517	134315007OPM	372	134619	391
10710342	494	117333	453	134122	138	134315007OR	372	13462101	377
10710342AC	494	117440	450	134122	64	134315008	372	13462102	379
10710342BM	494			134122AC	64	134315008AC	372	13462102AC	379
10710342KM	494			134122BM	64	134315008BM	372	13462102BM	379
10710342KMB	494	123100C	222	134122NM	64	134315008NM	372	13462102KMB	379
10710342NM	494	123100F	222	134123	138	134315008OM	372	13462102NM	379
10710342OM	494	123103	222	134123AC	64	134315008OR	372	13462102OM	379
10710342OP	494	123120	222	134123BM	64	134315009	376	13462102OP	379
10710342OPM	494	123125C	222	134123KM	64	134315010	375	13462102OPM	379
10710342OR	494	123125F	222	134123KMB	64	134315010AC	375	13462102OR	379
107103DA	76	123155C	224	134123NM	64	134315010BM	375	13462104	377
107131	399	123155F	224	134123OM	64	134315010KM	375	13462104AC	377
10716102	349	123167	223	134123OP	64	134315010KMB	375	13462104BM	377
10716102	88	123170	223	134123OPM	64	134315010NM	375	13462104KM	377
107167	81	123210	463	134123OPM	64	134315010OM	375	13462104KMB	377
10717002	81	123214	464	134123OR	64	134315010OP	375	13462104NM	377
				13413726	376	134315010OPM	375	13462104OM	377

REFERENCIA	Pág.	REFERENCIA	Pág.	REFERENCIA	Pág.	REFERENCIA	Pág.	REFERENCIA	Pág.
13462104OP	377	13495002KMB	365	16123602BM	415	181191	154	19016903BM	278
13462104OPM	377	13495002NM	365	16123602KM	415	181191	341	19016903KMB	278
13462104OR	377	13495002OM	365	16123602KMB	415	18119102	153	19016903NM	278
13462202	378	13495002OP	365	16123602NM	415	18119102	340	19016903OM	278
13462202AC	378	13495002OPM	365	16123602OP	415	181203	149	19016903OPM	278
13462202BM	378	13495002OR	365	16123602OPM	415	181217	149	19016904	278
13462202NM	378	1349500AC	365	16123602OR	415	181222	152	19016904AC	278
13462202OM	378	1349500BM	365	16123606AC	415	181223	152	19016904BM	278
13462202OR	378	1349500M	365	16123606BM	415	181341	448	19016904KMB	278
134627	386	1349500OR	365	134951	363	181436	445	19016904NM	278
134628	396	13495101	363	16123606KM	415	181437	460	19016904OM	278
134629	396	13495101AC	363	16123606KMB	415	181438	460	19016904OPM	278
13463301	377	13495101BM	363	16123606NM	415	181468	153	19016905	278
13463302	377	13495101KM	363	16123606OM	415	181474	153	19016905AC	278
13463303	377	13495101KMB	363	16123606OP	415	181540	447	19016905BM	278
13463310	490	13495101NM	363	16123606OPM	415	181903	149	19016905KMB	278
13463410	495	13495101OM	363	16123620AC	415	181920	151	19016905NM	278
13463410NM	495	13495101OP	363	16123620BM	415	183341	448	19016905OM	278
13463420	495	13495101OPM	363	16123620KM	415	186103	149	19016905OPM	278
13463420NM	495	13495101OR	363	16123620KMB	415	186120	151	19016906	278
13463430	494	13495102	363	16123620NM	415	186203	149	19016906AC	278
13463440	496	13495102AC	363	16123620OM	415	186217	149	19016906BM	278
13463450	491	13495102BM	363	16123620OP	415	186920	151	19016906NM	278
13463460	497	13495102KMB	363	16123620OPM	415	18718250	501	19016906OM	278
13463810	496	13495102NM	363	16123620OR	415			19017401	284
13463820	494	13495102NM	363	161445	468			19017401NM	284
13463910	490	13495102OP	363	161446	468	19016401	282	19017402	284
134714	364	13495102OPM	363	161447	468	19016401NM	282	19017402AC	284
134715	366	13495102OR	363	161475	400	19016402	282	19017402BM	284
134738	380	134951AC	363	161476	401	19016402AC	282	19017402KMB	284
13473850	380	134951BM	363	161835	392	19016402BM	282	19017402NM	284
13474010	493	134951NM	363	161839	404	19016402KMB	282	19017402OM	284
13474020	493	13499501	479	162161	352	19016402NM	282	19017402OPM	284
13474110	469	13499502	479	162161	143	19016402OM	282	19017403	283
13474110AC	469	13499503	480	16216150	501	19016402OPM	282	19017403AC	283
13474110BM	469	139441	451	162245	353	19016403	281	19017403BM	283
13474110NM	469			162245	143	19016403AC	281	19017403KMB	283
13474110OM	469			162245	67	19016403BM	281	19017403NM	283
13474210	498			16235590	459	19016403KMB	281	19017403OM	283
13474220	498			162435	445	19016403NM	281	19017403OPM	283
13474310	489			162436	446	19016403OM	281	19017404	283
13474320	489			162437	460	19016403OPM	281	19017404AC	283
13474330	489			162438	460	19016404	281	19017404BM	283
134748	385			162440	448	19016404AC	281	19017404KMB	283
134757	407			162441	446	19016404BM	281	19017404NM	283
134808	380			162442	447	19016404KMB	281	19017404OM	283
134818	379			162453	459	19016404NM	281	19017404OPM	283
134835	393			162456	459	19016404OM	281	19017405	283
134846	492			162540	447	19016404OPM	281	19017405AC	283
134870	500			162541	446	19016405	281	19017405BM	283
134871	500			162542	448	19016405AC	281	19017405KMB	283
134873	407			162543	447	19016405BM	281	19017405NM	283
134923	397			162544	459	19016405KMB	281	19017405OM	283
134940	366			162545	459	19016405NM	281	19017405OPM	283
13494010	486			162540	447	19016405OM	281	19017406	283
134940AC	366			162541	446	19016405OPM	281	19017406AC	283
134940BM	366			162840	485	19016406	281	19017406BM	283
134940KM	366			163333	462	19016406AC	281	19017406NM	283
134940KMB	366			169440	450	19016406BM	281	19017406OM	283
134940NM	366					19016406NM	281	19019601	287
134940OP	366					19016406OM	281	19031202	289
134940OPM	366					19016419	283	19031202AC	289
134940OR	366					19016419NM	283	19031202BM	289
13494110	486					19016429	282	19031202KMB	70
134944	364					19016429AC	282	19031202NM	289
134944AC	364					19016429BM	282	19031205KMB	289
134944BM	364					19016429KMB	282	19031205NM	289
134944NM	364					19016429NM	282	19031205OM	289
134944OM	364					19016429OPM	282	19031205OPM	289
134944OR	364					19016429OPM	282	19031205	289
134950	365					19016469	281	19031205AC	289
13495001	365					19016469AC	281	19031205BM	289
13495001AC	365					19016469BM	281	19031205KMB	289
13495001BM	365					19016469NM	281	19031205NM	289
13495001KM	365					19016469OM	281	19031205OM	289
13495001KMB	365					19016901	279	19031205OPM	289
13495001NM	365					19016901NM	279	19031205	289
13495001OM	365					19016902	278	19031205AC	289
13495001OP	365					19016902AC	278	19031205BM	289
13495001OPM	365					19016902BM	278	19031205KMB	289
13495001OR	365					19016902KMB	278	19031205NM	289
13495002	365					19016902NM	278	19031205OM	289
13495002AC	365					19016902OPM	278	19038501	287
13495002BM	365					19016903	278	19038701	190
13495002KM	365					19016903AC	278	19038701	201
								19038701NM	287

REFERENCIA	Pág.	REFERENCIA	Pág.	REFERENCIA	Pág.	REFERENCIA	Pág.	REFERENCIA	Pág.
19038702	158	19039307BM	128	20016201AC	103	20020303OM	96	20024501	127
19038702	144	19039307KMB	286	20016201BM	350	20020303OR	96	20030001	98
19038702	285	19039307KMB	128	20016201BM	103	20020304	95	20030001AC	98
19038702	70	19039307NM	114	20016201NM	350	20020304AC	95	20030001BM	98
19038702AC	285	19039307NM	286	20016201NM	103	20020304BL	95	20030001NM	98
19038702AC	70	19039307NM	128	20016201OM	350	20020304BM	95	20030001OM	98
19038702BM	285	19039307OM	286	20016201OM	103	20020304NE	95	20030001OR	98
19038702BM	70	19039307OM	128	20016201OR	350	20020304NM	95	20030002	99
19038702KMB	285	19039307OPM	286	20016201OR	103	20020304OM	95	20030002AC	99
19038702KMB	70	19039307OPM	128	20016203	350	20020304OR	95	20030002BM	99
19038702NM	285	19063502	400	20016203	103	20020305	96	20030002NM	99
19038702NM	70	19063502BM	400	20016203AC	350	20020305AC	96	20030002OM	99
19038702OM	285	19063502KMB	400	20016203AC	103	20020305BL	96	20030002OR	99
19038702OM	70	19063502NM	400	20016203BM	350	20020305BM	96	20044001	445
19038702OPM	285	19063502OM	400	20016203BM	103	20020305NE	96	20044001AC	445
19038702OPM	70	19063502OPM	400	20016203NM	350	20020305NM	96	20044001BM	445
19038705	114	19063504	399	20016203NM	103	20020305OM	96	20044001NE	445
19038705	104	19063504AC	399	20016203OM	350	20020305OR	96	20044001NM	445
19038705	285	19063504BM	399	20016203OM	103	20020306	95	20044001OM	445
19038705AC	114	19063504NM	399	20016203OR	350	20020306AC	95	20044002	447
19038705AC	104	19063504OM	399	20016203OR	103	20020306BL	95	20044002AC	447
19038705AC	285	19250730	498	20016701	100	20020306BM	95	20044002BM	447
19038705BM	114	19250730	433	20016701AC	100	20020306NE	95	20044002NM	447
19038705BM	104	19260603	429	20016701BM	100	20020306NM	95	20047501	402
19038705BM	285	19290603	433	20016701NM	100	20020306OM	95	20050301	98
19038705KMB	285			20016701OM	100	20020306OR	95	20050301	135
19038705NM	114	20		20016701OR	100	20020501	98	20050301AC	98
19038705NM	104	20010101	96	20017001	100	20020501AC	98	20050301BM	98
19038705NM	285	20010101D	96	20017001AC	100	20020501BL	98	20050301NM	98
19038705OM	104	20010102	95	20017001BM	100	20020501BM	98	20050301OM	98
19038705OM	285	20010102D	95	20017001NM	100	20020501NE	98	20050301OR	98
19038705OPM	285	20010301	96	20017001OM	100	20020501NM	98	20210301	43
19039301	190	20010301AC	96	20017001OR	100	20020501OM	98	20210301AC	43
19039301	200	20010301BL	96	20017701	324	20020501OR	98	20210301BM	43
19039301	286	20010301BM	96	20017701	101	20020502	98	20210301D	43
19039301NM	286	20010301D	96	20018001	326	20020502AC	98	20210301NM	43
19039302	177	20010301NE	96	20018001	101	20020502BL	98	20210301OM	43
19039302	158	20010301NM	96	20018001AC	326	20020502BM	98	20210301OR	43
19039302	144	20010301OM	96	20018001AC	101	20020502NE	98	20210302	43
19039302	286	20010301OR	96	20018001BM	326	20020502NM	98	20210302D	43
19039302AC	286	20010302	95	20018001BM	101	20020502OM	98	20210303	43
19039302BM	286	20010302AC	95	20018001NM	326	20020502OR	98	20210303AC	43
19039302KMB	286	20010302BL	95	20018001NM	101	20020503	98	20210303BM	43
19039302NM	286	20010302BM	95	20018001OM	326	20020503AC	98	20210303NM	43
19039302OM	286	20010302D	95	20018001OM	101	20020503BL	98	20210303OM	43
19039302OPM	286	20010302NE	95	20018001OR	326	20020503BM	98	20210303OR	43
19039305	168	20010302NM	95	20018001OR	101	20020503NE	98	20210304	43
19039305	285	20010302OM	95	20018002	329	20020503NM	98	20210305	44
19039305	128	20010302OR	95	20018002	102	20020503OM	98	20210305AC	44
19039305AC	285	20011001	97	20018005	331	20020503OR	98	20210305BM	44
19039305AC	128	20011001BL	97	20018005	103	20020504	97	20210305NM	44
19039305BM	285	20011001NE	97	20018005AC	331	20020504AC	97	20210305OM	44
19039305BM	128	20011002	96	20018005AC	103	20020504BL	97	20210305OR	44
19039305KMB	285	20011002BL	96	20018005BM	331	20020504BM	97	20210306	43
19039305KMB	128	20011002NE	96	20018005BM	103	20020504NE	97	20210501	44
19039305NM	285	20012001	99	20018005NM	331	20020504NM	97	20210501AC	44
19039305NM	128	20012001AC	99	20018005NM	103	20020504OM	97	20210501BM	44
19039305OM	285	20012001BL	99	20018005OM	331	20020504OR	97	20210501NM	44
19039305OM	128	20012001BM	99	20018005OM	103	20020505	97	20210501OM	44
19039305OPM	285	20012001D	99	20018005OR	331	20020505AC	97	20210501OR	44
19039305OPM	128	20012001NE	99	20018005OR	103	20020505BL	97	20212001	46
19039306	89	20012001NM	99	20018009	332	20020505BM	97	20212001AC	46
19039306	284	20012001OM	99	20018009	102	20020505NE	97	20212001BM	46
19039306	51	20012001OR	99	20018010	326	20020505NM	97	20212001D	46
19039306AC	89	20012002	99	20018010	101	20020505OM	97	20212001NM	46
19039306AC	284	20012002AC	99	20018010OM	326	20020505OR	97	20212001OM	46
19039306AC	51	20012002BL	99	20018010OM	101	20020506	97	20212001OR	46
19039306BM	89	20012002BM	99	20018010OR	326	20020506AC	97	20212002	46
19039306BM	284	20012002D	99	20018010OR	101	20020506BL	97	20212002D	46
19039306BM	51	20012002NE	99	20018011	328	20020506BM	97	20216101	348
19039306NM	89	20012002NM	99	20018011	101	20020506NE	97	20216101	50
19039306NM	284	20012002OM	99	20018080	332	20020506NM	97	20216101AC	348
19039306NM	51	20012002OR	99	20018080	102	20020506OM	97	20216101AC	50
19039306OM	89	20013001	99	20018201	405	20020506OR	97	20216101BM	348
19039306OM	284	20013001AC	99	20018201AC	405	20022401	99	20216101NM	50
19039306OM	51	20013001BM	99	20018201BM	405	20022401AC	99	20216101OM	348
19039307	169	20013001KM	99	20018201NM	405	20022401BL	99	20216101OR	50
19039307	178	20013001KMB	99	20018201OM	405	20022401BL	99	20216101OM	348
19039307	114	20013001NM	99	20018201OR	405	20022401NE	99	20216101OM	50
19039307	286	20013001OM	99	20018301	408	20022401NM	99	20216101OR	348
19039307	128	20013001OP	99	20020303	96	20022401OM	99	20216101OR	50
19039307AC	114	20013001OPM	99	20020303AC	96	20022401OR	99	20216103	348
19039307AC	286	20013001OR	99	20020303BL	96	20024501	353	20216103	50
19039307AC	128	20016201	350	20020303BM	96	20024501	168	20216103AC	348
19039307BM	114	20016201	103	20020303NE	96	20024501	87	20216103AC	50
19039307BM	286	20016201AC	350	20020303NM	96	20024501	88	20216103BM	348

REFERENCIA	Pág.	REFERENCIA	Pág.	REFERENCIA	Pág.	REFERENCIA	Pág.	REFERENCIA	Pág.
20216103BM	50	202278100M	48	20230002OR	46	20322401	151	20528006	166
20216103NM	348	202278100R	302	20230003	46	20324501	353	20528006	320
20216103OM	50	202278100R	48	20230003AC	46	20324501	157	20528110	165
20216103OR	348	20228003	313	20230003BM	46	20324501	103	20528110	307
20216701	47	20228003AC	49	20230003NM	46	20324501	143	20530001	163
20216701AC	47	20228003AC	313	20230003OM	46	20340301	150	20530002	163
20216701BM	47	20228003BM	313	20230003OR	46	20370301	150	20530011	163
20216701NM	47	20228003BM	49	20230004	46	20410301	173	20530012	163
20216701OM	47	20228003NM	313	20230004AC	46	20410301D	173	20544001	446
20216701OR	47	20228003NM	49	20230004BM	46	20412001	173	20544001AC	446
20217001	47	20228003OM	313	20230004NM	46	20412001D	173	20544001BM	446
20217001AC	47	20228003OR	49	20230004OM	46	20416701	174	20544001NM	446
20217001BM	47	20228004	309	20230004OR	46	20417001	174	20544001OM	446
20217001NM	47	20228004AC	309	20230011	45	20417701	325	20548601	445
20217001OM	47	20228004AC	48	20230011AC	45	20417701	176	20548601AC	445
20217001OR	47	20228004BM	309	20230011BM	45	20418001	327	20548601BM	445
20218201	406	20228004BM	309	20230011NM	45	20418001	176	20548601NM	445
20218201AC	406	20228004BM	48	20230011OM	45	20418002	331	20548601OM	445
20218201BM	406	20228004NM	309	20230011OR	45	20418002	177	20548702	457
20218201NM	406	20228004NM	48	20230012	45	20418005	334	20548702AC	457
20218201OM	406	20228004OM	309	20230012AC	45	20418005	177	20548702BM	457
20218201OR	406	20228004OM	48	20230012BM	45	20425001	258	20548702NM	457
20219101	338	20228004OR	309	20230012NM	45	20425003	169	20560301	429
20219101AC	338	20228004OR	48	20230012OM	45	20425003	178	20560302	432
20219101BM	338	20228005	312	20230012OR	45	20425003	265	20718107	502
20219101NM	338	20228005AC	312	20230013	45	20425004	169	20718107AC	502
20219101OM	338	20228005AC	49	20230013AC	45	20425004	178	20718107BM	502
20219101OR	338	20228005BM	312	20230013BM	45	20425004	261	20718107NM	502
20224501	50	20228005BM	49	20230013NM	45	20425005	267	20718107OM	502
20224501	50	20228005NM	49	20230013OM	45	20425006	270	20718107OR	502
20225053	52	20228005OM	312	20230013OR	45	20427810	174	20718201	293
20225053AC	263	20228005OR	312	20230014	45	20427810	304	20718201	405
20225053BM	263	20228006	316	20230014AC	45	20428003	175	20718201	421
20225053NM	263	20228006AC	49	20230014BM	45	20428003	316	20718201	233
20225053OM	263	20228006AC	316	20230014NM	45	20428004	175	20718201AC	293
20225053OR	263	20228006BM	49	20230014OM	45	20428004	312	20718201AC	405
20225054	259	20228006BM	49	20230014OR	45	20428005	175	20718201AC	421
20225054AC	259	20228006NM	316	20261310	429	20428005	318	20718201AC	233
20225054BM	259	20228006NM	49	20261310AC	44	20428006	176	20718201BM	293
20225054NM	259	20228006OM	316	20261310AC	429	20428006	321	20718201BM	405
20225054OM	259	20228006OR	316	20261310BM	44	20428110	174	20718201BM	421
20225054OR	259	20228007	319	20261310BM	429	20428110	308	20718201BM	233
20225055	262	20228007AC	319	20261310NM	44	20430001	173	20718201NM	293
20225055AC	262	20228007AC	50	20261310NM	429	20430002	173	20718201NM	405
20225055AC	262	20228007BM	319	20261310OM	44	20510301	163	20718201NM	421
20225055BM	52	20228007BM	50	20261310OR	429	20510301D	163	20718201NM	233
20225055NM	262	20228007NM	50	20261310OR	44	20510303	163	20718201OM	293
20225055OM	262	20228007NM	319	20261310OR	44	20511201	472	20718201OM	405
20225055OR	262	20228007OM	50	20261310OR	44	20511202	472	20718201OM	421
20225056	268	20228007OR	50	20261320	432	20512001	164	20718201OM	233
20225056AC	268	20228110	305	20261320AC	44	20512001D	164	20718201OPM	421
20225056BM	268	20228110AC	305	20261320AC	432	20516101	351	20718201OPM	233
20225056NM	268	20228110AC	48	20261320BM	44	20516101	168	20718201OR	293
20225056OM	268	20228110AC	305	20261320BM	44	20516103	351	20718201OR	405
20225056OR	268	20228110BM	305	20261320NM	432	20516103	168	20718201OR	421
20225057	270	20228110BM	48	20261320NM	44	20516701	164	20718201OR	233
20225057AC	270	20228110BM	48	20261320OM	432	20517001	164	20725001	507
20225057BM	270	20228110NM	305	20261320OM	44	20517701	166	20785001	19
20225057OM	270	20228110NM	305	20261320OR	44	20517701	324	20785001	256
20225057OR	270	20228110OM	305	20263901	381	20518001	166	20827810	208
20227810	302	20228110OM	48	20263901AC	381	20518001	326	20827810	217
20227810AC	302	20228110OR	305	20263901AC	381	20518002	167	20827810	188
20227810BM	302	20228110OR	48	20263901BM	381	20518002	329	20827810	198
20227810NM	302	20228110OR	48	20263901BM	381	20518006	167	20827810	164
20227810OM	302	20228110OR	48	20263901KMB	381	20518006	329	20827810	83
20227810OR	302	20228110OR	48	20263901KMB	381	20518007	167	20827810	174
20227810AC	48	20228110AC	305	20263901NM	381	20518007	333	20827810	113
20227810BM	302	20228110AC	48	20263901NM	381	20518007	407	20827810	139
20227810NM	302	20228110BM	305	20263901OM	381	20518301	100	20827810	124
20227810OM	302	20228110BM	48	20263901OP	381	20522201	100	20827810	302
20227810OR	302	20228110NM	305	20263901OPM	381	20522201AC	100	20827810	48
20227810AC	48	20228110NM	48	20263901OPM	381	20522201BM	100	20827810	65
20227810BM	302	20228110OM	305	20263901OR	381	20522201NM	100	20827810	208
20227810NM	302	20228110OM	48	20310301	149	20522301	100	20828110	217
20227810OM	302	20228110OR	305	20310301D	149	20522301AC	100	20828110	188
20227810OR	302	20228110OR	48	20312001	151	20522301BM	100	20828110	199
20227810AC	48	20228110OR	48	20316101	352	20522301NM	100	20828110	165
20227810BM	302	20230001	45	20316101	157	20522301OM	100	20828110	83
20227810NM	302	20230001AC	45	20316102	157	20522301OR	100	20828110	174
20227810OM	302	20230001BM	45	20317701	324	20527810	164	20828110	113
20227810OR	302	20230001NM	45	20317701	156	20527810	303	20828110	139
20227810AC	48	20230001OM	45	20318001	326	20528003	165	20828110	125
20227810BM	302	20230001OM	45	20318001	156	20528003	314	20828110	302
20227810NM	302	20230002AC	46	20318002	330	20528004	165	20828110	48
20227810OM	302	20230002BM	46	20318002	156	20528004	310	20828110	65
20227810OR	302	20230002NM	46	20320002	150	20528005	166	-	-
20227810OM	302	20230002OM	46	20321001	150	20528005	317	-	-

REFERENCIA	Pág.	REFERENCIA	Pág.	REFERENCIA	Pág.	REFERENCIA	Pág.	REFERENCIA	Pág.
21		21112002KM	123	21120301OR	120	21125005OP	262	21128005	313
21018107	502	21112002KMB	123	21120302	119	21125005OPM	129	21128005AC	126
21018107AC	502	21112002NM	123	21120302AC	119	21125005OPM	262	21128005AC	313
21018107BM	502	21112002OM	123	21120302BM	119	21125005OR	129	21128005BM	126
21018107KM	502	21112002OP	123	21120302KM	119	21125005OR	262	21128005BM	313
21018107KMB	502	21112002OPM	123	21120302KMB	119	21125006	266	21128005KM	126
21018107NM	502	21112002OR	123	21120302NM	119	21125006AC	266	21128005KM	313
21018107OM	502	21116101	350	21120302OM	119	21125006BM	266	21128005KMB	126
21018107OP	502	21116101	127	21120302OP	119	21125006KM	266	21128005KMB	313
21018107OPM	502	21116101AC	350	21120302OPM	119	21125006KMB	266	21128005NM	126
21018107OR	502	21116101AC	127	21120302OR	119	21125006NM	266	21128005NM	313
21027301	293	21116101BM	350	21120501	121	21125006OM	266	21128005OM	126
21027301AC	293	21116101BM	127	21120501AC	121	21125006OP	266	21128005OM	313
21027301BM	293	21116101KM	350	21120501BM	121	21125006OPM	266	21128005OP	126
21027301NM	293	21116101KM	127	21120501BM	121	21125006OR	266	21128005OP	313
21027301OM	293	21116101KMB	350	21120501KMB	121	21125007	270	21128005OPM	126
21027301OR	293	21116101KMB	127	21120501NM	121	21125007AC	270	21128005OPM	313
21027303	294	21116101NM	350	21120501OM	121	21125007BM	270	21128005OR	126
21027303AC	294	21116101NM	127	21120501OP	121	21125007KM	270	21128005OR	313
21027303BM	294	21116101OM	350	21120501OPM	121	21125007KMB	270	21128006	126
21027303NM	294	21116101OM	127	21120501OR	121	21125007NM	270	21128006	317
21027303OM	294	21116101OP	350	21122401	123	21125007NM	270	21128006AC	126
21027303OR	294	21116101OP	127	21122401AC	123	21125007OP	270	21128006AC	317
21027304	294	21116101OPM	350	21122401BM	123	21125007OPM	270	21128006BM	126
21027305	294	21116101OPM	127	21122401BM	123	21125007OR	270	21128006BM	317
21027310	295	21116101OR	350	21122401KM	123	21127810	124	21128006BM	126
21027311	295	21116101OR	127	21122401NM	123	21127810	303	21128006KM	317
21027311AC	295	21116103	351	21122401OM	123	21127810AC	124	21128006KMB	126
21027311BM	295	21116103	127	21122401OP	123	21127810AC	303	21128006KMB	317
21027311NM	295	21116103AC	351	21122401OPM	123	21127810BM	124	21128006NM	126
21027312	296	21116103AC	127	21122401OR	123	21127810BM	303	21128006NM	317
21027313	296	21116103BM	351	21125001	257	21127810BM	124	21128006NM	317
21027313AC	296	21116103BM	127	21125001AC	257	21127810KMB	124	21128006OM	126
21027313BM	296	21116103KM	351	21125001AC	257	21127810KMB	303	21128006OM	317
21027313NM	296	21116103KM	127	21125001BM	257	21127810KMB	124	21128006OP	126
21027391	293	21116103KMB	351	21125001KM	257	21127810KMB	303	21128006OP	317
21027391AC	293	21116103KMB	127	21125001KMB	257	21127810KMB	124	21128006OPM	126
21027391BM	293	21116103NM	351	21125001NM	257	21127810NM	124	21128006OPM	317
21027391NM	293	21116103NM	127	21125001OM	257	21127810NM	303	21128006OPM	126
21027391OM	293	21116103NM	351	21125001OP	257	21127810NM	124	21128006OR	126
21027391OR	293	21116103OM	351	21125001OPM	257	21127810OM	303	21128006OR	317
21027399	293	21116103OP	127	21125001OPM	257	21127810OP	124	21128007	320
21027399AC	293	21116103OP	351	21125001OR	257	21127810OP	303	21128007AC	126
21027399BM	293	21116103OPM	127	21125003	128	21127810OPM	124	21128007AC	320
21027399NM	293	21116103OPM	351	21125003AC	128	21127810OPM	303	21128007AC	320
21027399OM	293	21116103OPM	127	21125003AC	264	21127810OR	124	21128007BM	126
21027399OR	293	21116103OR	351	21125003AC	264	21127810OR	303	21128007BM	320
21110301	119	21116103OR	127	21125003BM	128	21128003	125	21128007BM	126
21110301AC	119	21116103OR	351	21125003BM	264	21128003	314	21128007KM	126
21110301BM	119	21116701	124	21125003KMB	128	21128003AC	125	21128007KM	320
21110301D	119	21116701AC	124	21125003KMB	264	21128003AC	314	21128007KMB	126
21110301KM	119	21116701BM	124	21125003NM	128	21128003AC	125	21128007KMB	320
21110301KMB	119	21116701KMB	124	21125003NM	264	21128003AC	314	21128007KMB	126
21110301NM	119	21116701KMB	124	21125003OM	128	21128003BM	125	21128007KMB	320
21110301OM	119	21116701NM	124	21125003OM	264	21128003BM	314	21128007NM	126
21110301OP	119	21116701OM	124	21125003OP	128	21128003BM	125	21128007NM	320
21110301OPM	119	21116701OP	124	21125003OP	264	21128003BM	314	21128007OM	126
21110302	119	21117001	124	21125003OPM	128	21128003KM	125	21128007OM	320
21110302AC	119	21117001AC	124	21125003OPM	264	21128003KMB	125	21128007OP	126
21110302BM	119	21117001BM	124	21125003OPM	264	21128003KMB	314	21128007OP	320
21110302D	119	21117001KM	124	21125003OPM	128	21128003KMB	125	21128007OPM	126
21110302KM	119	21117001KMB	124	21125003OR	264	21128003NM	125	21128007OPM	320
21110302KMB	119	21117001KMB	124	21125004	260	21128003NM	314	21128007OPM	126
21110302NM	119	21117001NM	124	21125004AC	260	21128003OM	125	21128007OR	126
21110302OM	119	21117001NM	124	21125004BM	260	21128003OM	314	21128007OR	320
21110302OP	119	21117001OM	124	21125004KMB	260	21128003OP	125	21128110	125
21110302OPM	119	21117001OP	124	21125004KMB	260	21128003OP	314	21128110	306
21110302OR	119	21117001OPM	124	21125004NM	260	21128003OPM	125	21128110AC	125
21112001	123	21118201	406	21125004NM	260	21128003OPM	314	21128110AC	306
21112001AC	123	21118201AC	406	21125004OM	260	21128003OR	125	21128110AC	125
21112001BM	123	21118201AC	406	21125004OP	260	21128003OR	314	21128110BM	125
21112001D	123	21118201BM	406	21125004OPM	260	21128004	125	21128110BM	306
21112001KM	123	21118201KM	406	21125004OR	260	21128004AC	125	21128110BM	125
21112001KMB	123	21118201KMB	406	21125005	129	21128004AC	310	21128110KMB	125
21112001NM	123	21118201KMB	406	21125005AC	129	21128004BM	125	21128110KMB	306
21112001OM	123	21118201NM	406	21125005AC	262	21128004BM	310	21128110KMB	125
21112001OP	123	21118201NM	406	21125005BM	129	21128004BM	125	21128110NM	125
21112001OPM	123	21118201OM	406	21125005BM	262	21128004BM	310	21128110NM	306
21112001OR	123	21118201OP	406	21125005KMB	129	21128004KM	125	21128110NM	125
21112002	123	21118201OPM	406	21125005NM	262	21128004KM	310	21128110OM	125
21112002AC	123	21120301	120	21125005NM	129	21128004KMB	125	21128110OM	306
21112002BM	123	21120301AC	120	21125005NM	262	21128004KMB	310	21128110OP	125
21112002D	123	21120301BM	120	21125005OM	129	21128004KMB	125	21128110OP	306
		21120301KM	120	21125005OM	262	21128004NM	125	21128110OPM	125
		21120301KMB	120	21125005OM	129	21128004NM	310	21128110OPM	306
		21120301NM	120	21125005OP	129	21128004OM	125	21128110OR	125
		21120301OM	120			21128004OM	310	21128110OR	306
		21120301OP	120			21128004OP	125	21130001	122
		21120301OPM	120			21128004OP	310	21130001AC	122
						21128004OPM	125	21130001BM	122
						21128004OPM	310	21130001KM	122
						21128004OR	125	21130001KMB	122
						21128004OR	310	21130001NM	122
						21128005	126	21130001OM	122

REFERENCIA	Pág.	REFERENCIA	Pág.	REFERENCIA	Pág.	REFERENCIA	Pág.	REFERENCIA	Pág.
21130001OP	122	21190401KM	120	21619601	288	21828003	315	24212101OR	26
21130001OPM	122	21190401KMB	120	21619601NM	210	21828004	188	24212201	26
21130001OR	122	21190401NM	120	21619601NM	288	21828004	311	24212201AC	26
21130002	123	21190401OM	120	21625001	258	21828005	189	24212201LM	26
21130002AC	123	21190401OP	120	21625001NM	258	21828005	318	24212201LV	26
21130002BM	123	21190401OPM	120	21625004	211	21828006	189	24212201OR	26
21130002KM	123	21190401OR	120	21625004	261	21828006	321	24212202	26
21130002KMB	123	21190501	120	21626710	206	21828110	188	24212202AC	26
21130002NM	123	21190501AC	120	21627010	206	21828110	307	24212202LM	26
21130002OM	123	21190501BM	120	21627810	208	21830003	184	24212202LV	26
21130002OP	123	21190501KM	120	21627810	305	21830004	184	24212202OR	26
21130002OPM	123	21190501KMB	120	21628004	208	21830010	501	24214501	32
21130002OR	123	21190501NM	120	21628004	312	21830801	184	24214501AC	32
21130011	122	21190501OM	120	21628110	208	21830802	184	24214501LM	32
21130011AC	122	21190501OP	120	21628110	308	21831221	187	24214501LV	32
21130011BM	122	21190501OPM	120	21631221	207	21831221	344	24214501OR	32
21130011KM	122	21190501OR	120	21631221	345	21880301	184	24214601	32
21130011KMB	122	21190601	121	2163200311	477	21899501	186	24214601AC	32
21130011NM	122	21190601AC	121	21632010	455	21899501	343	24214601LM	32
21130011OM	122	21190601BM	121	21632020	455			24214601LV	32
21130011OP	122	21190601KM	121	21632030	455			24214601OR	32
21130011OPM	122	21190601KMB	121	21639301	210	23444005	524	24214602	32
21130011OR	122	21190601NM	121	21639302NM	210	23461013	524	24214602AC	32
21130012	122	21190601OM	121	21639502NM	211	23461015	524	24214602LM	32
21130012AC	122	21190601OP	121	21639521	211	23461038	525	24214602LV	32
21130012BM	122	21190601OPM	121	21642010	456	23461050	524	24214602OR	32
21130012KM	122	21190601OR	121	21644010	450	23461301	524	24215101	25
21130012KMB	122	21210001	473	21644020	450	23461303	524	24215101AC	25
21130012NM	122	21210301	472	21644710	449	23461305	524	24215101LM	25
21130012OM	122	21220001	474	21644720	449	23461380	524	24215101LV	25
21130012OP	122	21510303	215	21710301	195	23461501	524	24215101OR	25
21130012OPM	122	21510303D	215	21710303	195	23466001	524	24215102	25
21130012OR	122	21510310	215	21710401	195	23466203	524	24215102AC	25
21130501	121	21510310D	215	21712001	196	23466205	524	24215102LM	25
21130501AC	121	21510410	215	21712301	185	23466905	525	24215102LV	25
21130501BM	121	21510410D	216	21712301	196	23466938	525	24215102OR	25
21130501KM	121	21512010	216	21716401	282	23467205	525	24215501	39
21130501KMB	121	21512010D	216	21716409	282	23467238	525	24215501AC	39
21130501NM	121	21516710	216	21716701	197	23468301	525	24215501LM	39
21130501OM	121	21517010	217	21717001	197	23468303	525	24215501LV	39
21130501OP	121	21517701	218	21717701	200			24215501OR	39
21130501OPM	121	21517701	325	21717701	325			24215502	39
21130501OR	121	21518001	218	21718001	200	24210201	23	24215502AC	39
21140501	121	21518001	327	21718001	327	24210201AC	23	24215502LM	39
21140501AC	121	21518201	406	21719101	198	24210201LM	23	24215502LV	39
21140501BM	121	21525001	258	21719101	344	24210201LV	23	24215502OR	39
21140501KM	121	21525004	159	21720301	195	24210201OR	23	24216301	27
21140501KMB	121	21525004	262	21720303	195	24210301	23	24216301AC	27
21140501NM	121	21525004NM	262	21725001	257	24210301AC	23	24216301LM	27
21140501OM	121	21526710	216	21725003	191	24210301LM	23	24216301LV	27
21140501OP	121	21527010	217	21725003	201	24210301LV	23	24216301OR	27
21140501OPM	121	21527810	217	21725003	265	24210301OR	23	24216402	34
21140501OR	121	21527810	305	21725004	191	24210501	24	24216402AC	34
21150301	122	21528110	217	21725004	201	24210501AC	24	24216402LM	34
21150301AC	122	21528110	308	21725004	261	24210501LM	24	24216402LV	34
21150301BM	122	21530601	219	21725005	267	24210501LV	24	24216409	33
21150301KM	122	21533301	452	21725006	269	24210501OR	24	24216409AC	33
21150301KMB	122	21544101	451	21726701	197	24210601	24	24216409LM	33
21150301NM	122	21550601	219	21727001	197	24210601AC	24	24216409LV	33
21150301OM	122	21552001	219	21727810	198	24210601LM	24	24216409OR	33
21150301OP	122	21552002	219	21727810	304	24210601LV	24	24216701	27
21150301OPM	122	21599002	218	21728003	199	24210601OR	24	24216701AC	27
21150301OR	122	21599002	331	21728003	315	24210801	23	24216701LM	27
21180301	120	2161030111	477	21728004	199	24210801AC	23	24216701LV	27
21180301AC	120	21610303	205	21728004	311	24210801LM	23	24216701OR	27
21180301BM	120	21610303NM	205	21728110	199	24210801LV	23	24217001	27
21180301KM	120	21610310	205	21728110	307	24210801OR	23	24217001AC	27
21180301KMB	120	21610410	205	21730001	196	24210901	23	24217001LM	27
21180301NM	120	21612010	205	21730002	196	24210901AC	23	24217001LV	27
21180301OM	120	21612010NM	205	21731221	198	24210901LM	23	24217001OR	27
21180301OP	120	21616401	209	21731221	344	24210901LV	23	24217301	24
21180301OPM	120	21616401NM	209	21810301	183	24210901OR	23	24217301AC	24
21180301OR	120	21616409	209	21810303	183	24210902	23	24217301LM	24
21180302	119	21616409NM	209	21810401	183	24210902AC	23	24217301LV	24
21180302AC	119	21616710	206	21812001	185	24210902LM	23	24217301OR	24
21180302BM	119	21616710NM	206	21816701	185	24210902LV	23	24217302	24
21180302KM	119	21617010	206	21817001	186	24210902OR	23	24217302AC	24
21180302KMB	119	21617010NM	206	21819101	187	24212001	26	24217302LM	24
21180302NM	119	21617701	209	21819101	343	24212001AC	26	24217302LV	24
21180302OM	119	21617701	325	21820301	183	24212001LM	26	24217302OR	24
21180302OP	119	21618001	209	21820303	183	24212001LV	26	24217409	33
21180302OPM	119	21618001	327	242126701	185	24212001OR	26	24217409AC	33
21180302OR	119	21618201	406	21827001	186	24212101	26	24217409LM	33
21190401	120	21619110	207	21827810	188	24212101AC	26	24217409LV	33
21190401AC	120	21619110	345	21827810	304	24212101LM	26	24217409OR	33
21190401BM	120	21619601	210	21828003	189	24212101LV	26	24217601	27

23

24

REFERENCIA	Pág.	REFERENCIA	Pág.	REFERENCIA	Pág.	REFERENCIA	Pág.	REFERENCIA	Pág.
24217601AC	27	24220001LM	24	24273201	393	26110502OP	60	26218004NM	502
24217601LM	27	24220001LV	24	24273201AC	29	26110502OPM	60	26218004OM	502
24217601LV	27	24220001OR	24	24273201AC	393	26110502OR	60	26218004OP	502
24217601OR	27	24221501	463	24273201LM	29	26112001	63	26218004OPM	502
24217602	28	24221501AC	463	24273201LM	393	26112001D	63	26218004OR	502
24217602AC	28	24221501LM	463	24273201LV	29	26116701	64	26222402	63
24217602LM	28	24221501LV	463	24273201LV	393	26116701AC	64	26222402AC	63
24217602LV	28	24221501OR	463	24284001	484	26116701BM	64	26222402BM	63
24217609	33	24222001	26	24284001AC	484	26116701KM	64	26222402KM	63
24217609AC	33	24222001AC	26	24284001AM	484	26116701KMB	64	26222402KMB	63
24217609LM	33	24222001LM	26	24284001BL	484	26116701NM	64	26222402NM	63
24217609LV	33	24222001LV	26	24284001BM	484	26116701OM	64	26222402OM	63
24217609OR	33	24222001OR	26	24284001KM	484	26116701OP	64	26222402OP	63
24217701	30	24230601	25	24284001KMB	484	26116701OPM	64	26222402OPM	63
24217701AC	30	24230601AC	25	24284001LM	484	26116701OR	64	26222402OR	63
24217701LM	30	24230601LM	25	24284001LV	484	26116701TAM	64	26222402TAM	63
24217701LV	30	24230601LV	25	24284001NE	484	26116701TRO	64	26222402TRO	63
24217701OR	30	24230601OR	25	24284001NM	484	26117001	65	26225001	256
24217703	31	24231001	463	24284001OM	484	26117001AC	65	26225001AC	256
24217703AC	31	24231001AC	463	24284001OP	484	26117001BM	65	26225001BM	256
24217703LM	31	24231001LM	463	24284001OPM	484	26117001KM	65	26225001KM	256
24217703LV	31	24231001LV	463	24284001OR	484	26117001KMB	65	26225001KMB	256
24218001	30	24231001OR	463	24284001RO	484	26117001NM	65	26225001NM	256
24218001AC	30	24233401	462	24284002	484	26117001OM	65	26225001OM	256
24218001LM	30	24233401AC	462	24284002AC	484	26117001OP	65	26225001OP	256
24218001LV	30	24233401LM	462	24284002BL	484	26117001OPM	65	26225001OPM	256
24218001OR	30	24233401LV	462	24284002BM	484	26117001OR	65	26225001OR	256
24218003	30	24233401OR	462	24284002KM	484	26117001TAM	65	26225003	104
24218003AC	30	24234101	448	24284002KMB	484	26117001TRO	65	26225003	71
24218003LM	30	24234101AC	448	24284002LM	484	26118201	406	26225003	263
24218003LV	30	24234101LM	448	24284002LV	484	26118201AC	406	26225003AC	104
24218003OR	30	24234101LV	448	24284002NE	484	26118201BM	406	26225003AC	71
24218004	30	24234101OR	448	24284002NM	484	26118201KM	406	26225003AC	263
24218004AC	30	24234201	462	24284002OM	484	26118201KMB	406	26225003BM	104
24218004LM	30	24234201AC	462	24284002OP	484	26118201NM	406	26225003BM	71
24218004LV	30	24234201LM	462	24284002OPM	484	26118201OM	406	26225003BM	263
24218004OR	30	24234201LV	462	24284002OR	484	26118201OP	406	26225003KM	71
24218005	31	24234201OR	462	24284010	484	26118201OPM	406	26225003KM	263
24218005AC	31	24235201	36	24284020	484	26118201OR	406	26225003KMB	71
24218005LM	31	24235201AC	36	24287101	35	26130701	57	26225003KMB	263
24218005LV	31	24235201LM	36	24287101	499	26130701AC	57	26225003NM	104
24218005OR	31	24235201LV	36	24287101AC	35	26130701BM	57	26225003NM	71
24218006	31	24235201OR	36	24287101AC	499	26130701KM	57	26225003NM	263
24218006AC	31	24235202	36	24287101LM	35	26130701KMB	57	26225003OM	104
24218006LM	31	24235202AC	36	24287101LM	499	26130701NM	57	26225003OM	71
24218006LV	31	24235202LM	36	24287101LV	35	26130701OM	57	26225003OM	263
24218201	29	24235202LV	36	24287101LV	499	26130701OP	57	26225003OP	71
24218201AC	29	24235202OR	36	24287101NM	499	26130701OPM	57	26225003OP	263
24218201LM	29	24235203	36	24287101OR	35	26130701OR	57	26225003OPM	71
24218201LV	29	24235203AC	36	24287101OR	499	26130701TAM	57	26225003OPM	263
24218201OR	29	24235203LM	36	24287101OR	499	26130701TRO	57	26225003OR	104
24219101	28	24235203LV	36			26130801	57	26225003OR	71
24219101AC	28	24235301	37	25477001	510	26130801AC	57	26225003OR	263
24219101LM	28	24235301AC	37	25477002	510	26130801BM	57	26225004	105
24219101LV	28	24235301LM	37	25477003	511	26130801KM	57	26225004	71
24219401	33	24235301LV	37	25477004	510	26130801KMB	57	26225004	259
24219401AC	33	24235301OR	37	25477005	511	26130801NM	57	26225004AC	105
24219401LM	33	24244101	448	25477006	512	26130801OM	57	26225004AC	71
24219401LV	33	24244101AC	448	25477007	510	26130801OP	57	26225004AC	259
24219401OR	33	24244101LM	448	25477008	512	26130801OPM	57	26225004BM	105
24219402	32	24244101LV	448	25477009	511	26130801OR	57	26225004BM	71
24219402AC	32	24244101OR	448	25477010	512	26130801TAM	57	26225004BM	259
24219402LM	32	24247601	29	25477011	512	26130801TRO	57	26225004KM	71
24219402LV	32	24247601AC	29	25477012	511	26190301	57	26225004KM	259
24219403	35	24247601LM	29	25477013	512	26190301AC	57	26225004KMB	71
24219403	499	24247601LV	29	25477091	513	26190301BM	57	26225004KMB	259
24219403AC	35	24247602	28	25477092	513	26190301D	57	26225004NM	105
24219403AC	499	24247602AC	28			26190301KM	57	26225004NM	71
24219403LM	35	24247602LM	28			26190301KMB	57	26225004NM	259
24219403LM	499	24247602LV	28	26110501	60	26190301NM	57	26225004OM	105
24219403LV	35	24250001	39	26110501AC	60	26190301OM	57	26225004OM	71
24219403LV	499	24250001AC	39	26110501BM	60	26190301OP	57	26225004OM	259
24219501	34	24250001LM	39	26110501KMB	60	26190301OPM	57	26225004OP	71
24219501AC	34	24250001LV	39	26110501KMB	60	26190301OR	57	26225004OP	259
24219501LM	34	24250001OR	39	26110501NM	60	26190301TAM	57	26225004OPM	71
24219501LV	34	24250301	25	26110501OM	60	26190301TRO	57	26225004OPM	259
24219502	34	24250301AC	25	26110501OP	60	26212001	63	26225004OR	105
24219502AC	34	24250301LM	25	26110501OPM	60	26212001D	63	26225004OR	71
24219502LM	34	24250301LV	25	26110501OR	60	26212301	67	26225004OR	259
24219502LV	34	24250301OR	25	26110502	60	26215001	350	26225005	266
24219801	35	24252001	39	26110502AC	60	26215001	67	26225005AC	266
24219801AC	35	24252001AC	39	26110502BM	60	26218004	502	26225005BM	266
24219801LM	35	24252001LM	39	26110502KM	60	26218004AC	502	26225005KM	266
24219801LV	35	24252001LV	39	26110502KMB	60	26218004BM	502	26225005KMB	266
24220001	24	24252001OR	39	26110502NM	60	26218004KM	502	26225005NM	266
24220001AC	24	24273201	29	26110502OM	60	26218004KMB	502	26225005OM	266

REFERENCIA	Pág.	REFERENCIA	Pág.	REFERENCIA	Pág.	REFERENCIA	Pág.	REFERENCIA	Pág.
26225005OP	266	26228005OM	66	26230012OR	62	26290401OM	59	28125006	269
26225005OPM	266	26228005OP	317	26230701	58	26290401OP	59	28125006AC	269
26225005OR	266	26228005OPM	66	26230701AC	58	26290401OPM	59	28125006NM	269
26225006	268	26228005OPM	317	26230701BM	58	26290401OR	59	28127810	113
26225006AC	268	26228005OPM	66	26230701KM	58	26290401TAM	59	28127810	303
26225006BM	268	26228005OR	317	26230701KMB	58	26290401TRO	59	28127810AC	113
26225006KM	268	26228005OR	66	26230701NM	58	26290402	59	28127810AC	303
26225006KMB	268	26228006	319	26230701OM	58	26290402AC	59	28127810NM	113
26225006NM	268	26228006	67	26230701OP	58	26290402BM	59	28127810NM	303
26225006OM	268	26228006AC	319	26230701OPM	58	26290402KM	59	28128004	114
26225006OP	268	26228006AC	67	26230701OR	58	26290402KMB	59	28128004	310
26225006OPM	268	26228006BM	319	26230701TAM	58	26290402NM	59	28128004AC	114
26225006OR	268	26228006BM	67	26230701TRO	58	26290402OM	59	28128004AC	310
26227810	303	26228006KM	319	26230801	58	26290402OP	59	28128004NM	114
26227810	65	26228006KM	67	26230801AC	58	26290402OPM	59	28128004NM	310
26227810AC	303	26228006KMB	319	26230801BM	58	26290402OR	59	28128110	113
26227810AC	65	26228006KMB	67	26230801KM	58	26290402TAM	59	28128110	306
26227810BM	303	26228006NM	319	26230801KMB	58	26290402TRO	59	28128110AC	113
26227810BM	65	26228006NM	67	26230801NM	58	26290403	59	28128110AC	306
26227810KM	303	26228006OM	319	26230801OM	58	26290403AC	59	28128110NM	113
26227810KM	65	26228006OM	67	26230801OP	58	26290403BM	59	28128110NM	306
26227810KMB	303	26228006OP	319	26230801OPM	58	26290403KM	59	28130001	110
26227810KMB	65	26228006OP	67	26230801OR	58	26290403KMB	59	28130001AC	110
26227810NM	303	26228006OPM	319	26230801TAM	58	26290403NM	59	28130001NM	110
26227810NM	65	26228006OPM	67	26230801TRO	58	26290403OM	59	28130002	111
26227810OM	303	26228006OR	319	26247005	68	26290403OP	59	28130002AC	111
26227810OM	65	26228006OR	67	26247005AC	68	26290403OPM	59	28130002NM	111
26227810OP	303	26228110	306	26247005BM	68	26290403OR	59	28130003	111
26227810OP	65	26228110	65	26247005KM	68	26290403TAM	59	28130003AC	111
26227810OPM	303	26228110AC	306	26247005KMB	68	26290403TRO	59	28130003NM	111
26227810OPM	65	26228110AC	65	26247005NM	68			28130004	111
26227810OR	303	26228110BM	306	26247005OM	68			28130004AC	111
26227810OR	65	26228110BM	65	26247005OP	68	28110301	109	28130004NM	111
26228003	314	26228110KM	306	26247005OPM	68	28110301AC	109	28144701	110
26228003	66	26228110KM	65	26247005OR	68	28110301NM	109	28144701AC	110
26228003AC	314	26228110KMB	306	26247006	68	28110401	109	28144701NM	110
26228003AC	66	26228110KMB	65	26247006AC	68	28110401AC	109	28164701	110
26228003BM	314	26228110NM	306	26247006BM	68	28110401NM	109	28164701AC	110
26228003BM	66	26228110NM	65	26247006KM	68	28110402	109	28164701NM	110
26228003KM	314	26228110OM	306	26247006KMB	68	28110402AC	109	28180301	110
26228003KM	66	26228110OM	65	26247006NM	68	28110402NM	109	28180301AC	110
26228003KMB	314	26228110OP	306	26247006OM	68	28112001	111	28180301NM	110
26228003KMB	66	26228110OP	65	26247006OP	68	28112001AC	111	28184701	110
26228003NM	314	26228110OPM	306	26247006OPM	68	28112001NM	111	28184701AC	110
26228003NM	66	26228110OPM	65	26247006OR	68	28112301	111	28184701NM	110
26228003OM	314	26228110OR	306	26285305	61	28112301AC	111	28190301	109
26228003OM	66	26228110OR	65	26285305AC	61	28112301NM	111	28190301AC	109
26228003OP	314	26230001	62	26285305BM	61	28116701	112	28190301NM	109
26228003OP	66	26230001AC	62	26285305KM	61	28116701AC	112	28310301	17
26228003OPM	314	26230001BM	62	26285305KMB	61	28116701NM	112	28310301AC	17
26228003OPM	66	26230001KM	62	26285305NM	61	28117001	112	28310301NM	17
26228003OR	314	26230001KMB	62	26285305OM	61	28117001AC	112	28310301OM	17
26228003OR	66	26230001NM	62	26285305OP	61	28117001NM	112	28310301OPM	17
26228004	309	26230001OM	62	26285305OPM	61	28119101	112	28310501	17
26228004	66	26230001OP	62	26285305OR	61	28119101	339	28310501AC	17
26228004AC	309	26230001OPM	62	26285306	61	28119101AC	112	28310501NM	17
26228004AC	66	26230001OR	62	26285306AC	61	28119101AC	339	28310501OM	17
26228004BM	309	26230002	62	26285306BM	61	28119101NM	112	28310501OPM	17
26228004BM	66	26230002AC	62	26285306KM	61	28119101NM	339	28312001	18
26228004KM	309	26230002BM	62	26285306KMB	61	28119701	113	28312001AC	18
26228004KM	66	26230002KM	62	26285306NM	61	28119701	340	28312001NM	18
26228004KMB	309	26230002KMB	62	26285306OM	61	28119701AC	113	28312001OM	18
26228004KMB	66	26230002NM	62	26285306OP	61	28119701AC	340	28312001OPM	18
26228004NM	309	26230002OM	62	26285306OPM	61	28119701NM	113	28316301	18
26228004NM	66	26230002OP	62	26285306OR	61	28119701NM	340	28316301AC	18
26228004OM	309	26230002OPM	62	26285350	61	28120301	109	28316301NM	18
26228004OM	66	26230002OR	62	26285350	68	28120301AC	109	28316301OM	18
26228004OP	309	26230011	62	26290301	58	28120301NM	109	28316301OPM	18
26228004OP	66	26230011AC	62	26290301AC	58	28125001	257	28317601	18
26228004OPM	309	26230011BM	62	26290301BM	58	28125001AC	257	28317601AC	18
26228004OPM	66	26230011KM	62	26290301D	58	28125001NM	257	28317601NM	18
26228004OR	309	26230011KMB	62	26290301KM	58	28125003	264	28317601OM	18
26228004OR	66	26230011NM	62	26290301KMB	58	28125003AC	264	28317601OPM	18
26228005	317	26230011OM	62	26290301NM	58	28125003NM	264	28319401	19
26228005	66	26230011OP	62	26290301OM	58	28125004	115	28319401AC	19
26228005AC	317	26230011OPM	62	26290301OP	58	28125004AC	260	28319401NM	19
26228005AC	66	26230011OR	62	26290301OPM	58	28125004AC	115	28319401OM	19
26228005BM	317	26230012	62	26290301OR	58	28125004AC	260	28319401OPM	19
26228005BM	66	26230012AC	62	26290301TAM	58	28125004NM	115	28320301	17
26228005KM	317	26230012BM	62	26290301TRO	58	28125004NM	260	28320301AC	17
26228005KM	66	26230012KM	62	26290401	59	28125005	115	28320301NM	17
26228005KMB	317	26230012KMB	62	26290401AC	59	28125005	266	28320301OM	17
26228005KMB	66	26230012NM	62	26290401BM	59	28125005AC	115	28320301OPM	17
26228005NM	317	26230012OM	62	26290401KM	59	28125005AC	266	28325001	19
26228005NM	66	26230012OP	62	26290401KMB	59	28125005NM	115	28325001	256
26228005OM	317	26230012OPM	62	26290401NM	59	28125005NM	266	28325001AC	19

REFERENCIA	Pág.	REFERENCIA	Pág.	REFERENCIA	Pág.	REFERENCIA	Pág.	REFERENCIA	Pág.
28325001AC	256	29963109LM	384	29990303NM	368	30725206AC	249	30735206NM	248
28325001NM	19	29963109LV	29	29990303OM	368	30725206NM	249	30735206OM	248
28325001NM	256	29963109LV	384	29990303OP	368	30725206OP	249	30735206OP	248
28325001OM	19	29963109OR	29	29990303OPM	368	30725206OP	249	30735206OPM	248
28325001OM	256	29963109OR	384	29990303OR	368	30725206OPM	249	30735206OR	248
28325001OPM	19	29963110	384	29990304	369	30725206OR	249	30735301	246
28325001OPM	256	29963111	383	29990304AC	369	30725207	249	30735301AC	246
28330001	17	29963112	383	29990304BM	369	30725207AC	249	30735301NM	246
28330001AC	17	29963112AC	383	29990304NM	369	30725207NM	249	30735301OM	246
28330001NM	17	29963112BM	383	29990304OM	369	30725207OM	249	30735301OP	246
28330001OM	17	29963112KM	383	29990304OR	369	30725207OP	249	30735301OPM	246
28330001OPM	17	29963112KMB	383	29990306	369	30725207OPM	249	30735301OR	246
28330002	18	29963112NM	383	29990306AC	369	30725207OR	249	30735401	247
28330002AC	18	29963112OM	383	29990306BM	369	30725301	246	30735401AC	247
28330002NM	18	29963112OP	383	29990306NM	369	30725301AC	246	30735401NM	247
28330002OM	18	29963112OPM	383	29990306OM	369	30725301NM	246	30735401OM	247
28330002OPM	18	29963112OR	383	29990306OR	369	30725301OM	246	30735401OP	247
28380301	17	29963113	383	29990307	369	30725301OP	246	30735401OPM	247
28380301AC	17	29963113AC	383	29990307AC	369	30725301OPM	246	30735401OR	247
28380301NM	17	29963113BM	383	29990307BM	369	30725301OR	246		
28380301OM	17	29963113KM	383	29990307KM	369	30725305	250	39	
28380301OPM	17	29963113KMB	383	29990307KMB	369	30725305AC	250	39210301	433
	29	29963113NM	383	29990307NM	369	30725305AC	250	39210302	429
29908405	526	29963113OM	383	29990307OM	369	30725305NM	250	39210303	430
29908406	526	29963113OP	383	29990307OP	369	30725305OM	250	39210303	429
29911351	386	29963113OPM	383	29990307OPM	369	30725305OP	250	39210304	430
29912390	386	29963113OR	383	29990307OPM	369	30725305OPM	250	39210305	430
29916901	525	29963114	384	29990308	368	30725305OR	250	39210306	430
29916902	525	29963115	382	29990308AC	368	30725306	249	39210307	429
29919001	525	29963202	372	29990308BM	368	30725306AC	249	39210308	431
29919505	525	29963202AC	372	29990308NM	368	30725306NM	249	39210309	433
29919607	527	29963202AC	372	29990308NM	368	30725306OM	249	39210319	431
29928010	501	29963202BM	372	29995001	152	30725306OP	249	39210320	431
29933701	378	29963202OM	372	29995301	364	30725306OPM	249	39210390	434
29933701AC	378	29963202OR	372	29995301AC	364	30725306OR	249	39210391	434
29933701LM	378	29963203	372	29995301BM	364	30725401	247	39210397	434
29933701LV	378	29963203AC	372	29995301NM	364	30725401AC	247	39210399	434
29933701OR	378	29963203BM	372	29995301OM	364	30725401NM	247	39274101	435
29933703	375	29963203OR	372	29995301OR	364	30725401OM	247	39274102	435
29933703AC	375	29963203NM	372	29995501	363	30725401OP	247	39274201	436
29933703LM	375	29963203OM	372	29995501AC	363	30725401OPM	247	39274201AC	436
29933703LV	375	29963203OR	372	29995501BM	363	30725401OR	247	39274201BL	436
29933703OR	375	29963206	374	29995501NM	363	30725405	250		
299392134	527	29963901	404	29995801	365	30725405AC	250	49	
29943801	374	29963902	378	29996201	362	30725405NM	250	49286299	420
29951501	410	29963902AC	378	29997001	362	30725405OM	250	49286299	232
29951502	411	29963902BM	378	29997001AC	362	30725405OP	250	49286398	420
29951503	410	29963902KMB	378	29997001BM	362	30725405OPM	250	49286398	232
29951504	408	29963902NM	378	29997001NM	362	30725405OR	250	49286399	421
29951504AC	408	29963902NM	378	29997001NM	362	30725406AC	250	49286399	233
29951504BM	408	29963902OM	378	29997001OM	362	30725406AC	250	49286499	421
29951504NM	408	29963902OPM	378	29997001OR	362	30725406NM	250	49286499	233
29951504OM	408	29963902OR	378	29997101	362	30725406NM	250	49286499	233
29951504OR	408	29963910	404	29997201	362	30725406OM	250	49288299	420
29951505	408	29963910AC	404		30	30725406OP	250	49288299	232
29951505AC	408	29963910LM	404	30725201	246	30725406OPM	250	49288398	420
29951505BM	408	29963910LV	404	30725201AC	246	30725406OR	250	49288398	232
29951505NM	408	29963910OR	404	30725201NM	246	30735201	246	49288399	421
29951505OM	408	29963928	404	30725201OM	246	30735201AC	246	49288399	233
29951505OR	408	29966310	524	30725201OP	246	30735201NM	246	49288499	421
29951505OR	408	29974802	385	30725201OPM	246	30735201OM	246	49288499	233
29951506	409	29974901	382	30725201OPM	246	30735201OP	246		
29951507	409	29974904	382	30725201OR	246	30735201OPM	246	50	
29951607	364	29974906	383	30725204	248	30735201OR	246	50643703	460
29951607AC	364	29987001	500	30725204AC	248	30735204	247	50648603	444
29951607BM	364	29987002	499	30725204OM	248	30735204	115	50716703	81
29951607NM	364	29989601	527	30725204OPM	248	30735204	104	5071700203	81
29951607OM	364	29989602	527	30725204OR	248	30735204AC	247	50783903	404
29951607OR	364	29989603	527	30725205	248	30735204AC	115		
29952505	497	29990301	368	30725205	248	30735204AC	104	52	
29953202	369	29990301AC	368	30725205	89	30735204AC	70	5246360951	416
29955303	526	29990301BM	368	30725205	51	30735204AC	70		
29955304	526	29990301NM	368	30725205AC	248	30735204NM	247	53	
29955306	526	29990301NM	368	30725205AC	248	30735204NM	115	53049603	444
29961001	524	29990301OM	368	30725205AC	51	30735204NM	104	53049703	444
29961002	524	29990301OR	368	30725205NM	248	30735204NM	70	53049803	444
29961005	524	29990302	368	30725205NM	89	30735204OM	247		
29961006	524	29990302AC	368	30725205NM	51	30735204OM	104	56	
29963105	384	29990302BM	368	30725205OM	248	30735204OM	70	56243703	460
29963106	385	29990302NM	368	30725205OM	248	30735204OP	247	56244003	468
29963108	381	29990302OM	368	30725205OM	89	30735204OP	70		
29963109	29	29990302OPM	368	30725205OP	248	30735204OPM	247	91	
29963109	384	29990302OR	368	30725205OP	248	30735204OPM	247	9106006	524
29963109AC	29	29990303	368	30725205OPM	248	30735204OR	70	910618020	526
29963109AC	384	29990303AC	368	30725205OR	248	30735204OR	104	910719005	525
29963109LM	29	29990303BM	368	30725205OR	89	30735204OR	70	9107515	410
		29990303KMB	368	30725205OR	51	30735206	248	9107672	524
		29990303KMB	368	30725206	249	30735206AC	248	913010334	526

REFERENCIA	Pág.	REFERENCIA	Pág.	REFERENCIA	Pág.
9130190	525	9134682	524	963033331	526
913043810	525	91346825	524	966110301	526
913049310	525	91346826	524		
913214591	525	9134683	525		
9133317	525	9134712	389		
913331703	527	9134725	385		
9133317031	527	9134731	389		
913400831	527	9134731051	389		
9134008311	527	913473810	380		
9134011	478	913474410	504		
913412380	382	913474420	504		
913414580	500	913474430	504		
9134235	525	9134745051	493		
9134250	526	9134746051	490		
9134256	526	9134779	505		
913427210	526	9134780	505		
913427220	526	9134781	504		
913427510	526	9134784	504		
9134282	526	9134786	505		
9134283	526	9134787	505		
9134284	526	9134788	505		
9134286	526	913478906	506		
9134288	525	913478907	506		
9134290	525	913478908	506		
9134292	526	9134803	526		
9134293	526	9134806	526		
9134294	526	913480810	380		
9134296	526	913481810	379		
9134314	525	9134828	388		
9134315	525	9134830051	388		
9134316	525	9134830053	388		
9134319	525	9134830054	388		
9134415	411	913483005LM	388		
9134441	525	913483080	388		
9134450	386	913484005	526		
9134481	525	9134840061	526		
9134515	410	913484007	526		
9134525	497	913484016	526		
9134525NM	497	913484026	526		
9134577	524	913484057	526		
9134591	525	9134841	405		
9134592	525	9134848	405		
9134609	387	9134849	525		
913460910	387	9134867	388		
913460912	387	9134872	500		
913460912AC	387	9134880	525		
913460912BM	387	9134881	389		
913460912NM	387	9134882	527		
913460915	387	9134887	389		
913460915AC	387	9134890	527		
913460915BM	387	9134891	527		
913460915KM	387	9134893	527		
913460915KMB	387	9134895	527		
913460915NM	387	9134896	527		
913460915OM	387	9134897	527		
913460915OP	387	9134898	527		
913460915OPM	387	9134915	411		
913460915OR	387	916110348	490		
913460920	387	9161515	409		
9134609AC	387	916184010	526		
9134609BM	387	916184060	491		
9134609KM	387	916218005	526		
9134609KMB	387	9162292	526		
9134609NM	387	9174441	525		
9134609OM	387	919210318	527		
9134609OP	387	919260634	526		
9134609OPM	387	919416401	527		
9134609OR	387	9194283	525		
9134615	411	9194552	525		
9134630	388				
913463250	497				
913463320	496	9262503	524		
913463330	496				
9134665	524				
9134666	524	932010331	527		
9134668	524				
9134672	524				
9134672501	524	953044052	527		
9134673	524	9530440521	527		
9134673501	524	953331550	527		
9134673503	524	9533315501	527		
9134674	524	953331750	527		
9134677	524	9533317501	527		
9134681	524	9534294501	527		
91346815	524				
91346816	524				

92

93

95

96

Condiciones generales de venta

PRECIOS SIN IMPUESTOS (SIN IVA)

Precios

Los precios de esta tarifa, y cualquier anexo que publiquemos, deben considerarse "precios de venta recomendados para el cliente final antes de impuestos".

Los precios están sujetos a cualquier variación según las circunstancias del mercado, materias primas, mano de obra, impuestos... facturándose los que rijan el día de la expedición.

Pedidos

Se considerarán condicionales y sujetos, por lo tanto, a nuestra consideración.

Diseño

Nuestros modelos podrán ser modificados por exigencias de diseño, sin previo aviso, siempre en beneficio del artículo.

La documentación fotográfica y/o el diseño técnico reproducidos en los listados, catálogos, folletos y demás instrumentos publicitarios tienen valor indicativo, por lo que el cliente no podrá acogerse a ellos en caso de posibles quejas por disconformidad o diferencia con los productos suministrados. Las reclamaciones referentes a la falta de conformidad de los productos suministrados deberán realizarse, como máximo, en los quince días siguientes a la entrega de la mercancía en su lugar de destino.

Plazo de entrega

Nuestros plazos de entrega son siempre aproximados y no nos hacemos responsables de las consecuencias de cualquier retraso.

Expedición de productos

La mercancía viajará a portes pagados siempre que el pedido neto importe un mínimo de 150_\$. Si la compra es inferior a esta cantidad, viajará a portes pagados también pero realizaremos un cargo en la factura de 6_€ en concepto de transporte y gestión. Para las islas, si el importe del pedido asciende a un mínimo de 600_€, la mercancía viajará a portes pagados, si no, viajará siempre a portes debidos. Informamos que nuestro departamento de logística gestiona los pedidos de forma independiente y no acumula los mismos para alcanzar el importe mencionado.

El destinatario comprobará, al recibo de la mercancía, el estado de la misma, indicando en el albarán del transportista las posibles incidencias.

Garantía Tres

TRES COMERCIAL S.A. garantiza todos los productos comercializados bajo la marca TRES ante eventuales defectos estructurales, de material o de fabricación durante 3 años a partir de la fecha de compra por parte del consumidor final.

Adicionalmente, TRES COMERCIAL S.A., ofrece una Garantía Comercial de 2 años adicionales (**Garantía de 5 años en total**), exceptuando:

- Revestimientos de acabados especiales (aquellos distintos del cromo).
- Grifería electrónica distinta del producto Shower Technology Blue Edition.
- Columnas de ducha, cartuchos temporizados.
- Complementos y accesorios (flexos, mandos de ducha, rociadores, soportes, llaves de paso, etc.)
- Materiales de consumo (filtros, juntas, aireadores, etc.)

Esta garantía no modifica los derechos que la legislación local otorga al consumidor final frente al comercializador del producto y frente al fabricante en el caso de haber sido adquirido en un distribuidor oficial.

Prerrequisitos de la Garantía

Para ejercer una reclamación de garantía es condición indispensable la presentación de una factura de compra donde se identifique claramente la fecha de compra y el distribuidor autorizado.

Para ejercer una reclamación de garantía el producto debe estar correctamente instalado, el uso debe haber sido de acuerdo con lo esperado para ese producto y la limpieza y mantenimiento debe haberse realizado de acuerdo a las indicaciones recogidas en el manual.

Servicios dentro del plazo de la Garantía

TRES COMERCIAL S.A. tiene la potestad de decidir la gestión a realizar, según la tipología del producto, entre la reparación por un Servicio Técnico Oficial, el suministro de un recambio para la reparación, la reparación en las instalaciones de TRES COMERCIAL S.A. o el cambio por un producto igual o similar en el caso de que el producto esté discontinuado.

Condiciones y exclusiones

TRES COMERCIAL S.A. se exime de toda responsabilidad:

- Si el producto no se ha instalado, mantenido y limpiado conforme a las instrucciones del mismo, incluidas en cada producto y disponibles en www.tresgriferia.com
- Si el producto no ha recibido el uso esperado para la tipología de producto.
- Si monta piezas no originales o evidencia signos de manipulación indebida.
- Si los defectos son resultado del transporte y/o la instalación.
- Si los elementos reclamados son aquellos sujetos a desgaste y éste es el normal para el uso dado.
- Si el defecto se produce por elementos externos agresivos (químicos, productos de limpieza corrosivos, instalación en ambientes agresivos, exceso de cal, hielo...)
- Si el defecto se produce por circunstancias ambientales (variaciones de presión, temperaturas extremas...)
- En caso de faltar un componente si éste no se ha reclamado en un plazo de 30 días desde la fecha de compra.

Límites de la Garantía

La eventual reparación, sustitución o cualquier prestación de servicio sobre el producto afectado, no extiende esta Garantía Comercial.

Para que esta Garantía sea válida, es necesario en cada caso, la aceptación del defecto por nuestro departamento técnico. En caso de que el producto analizado no presente ningún defecto cubierto por esta Garantía, se procederá a los siguientes cargos en concepto de Servicio Técnico:

- 12_€ (IVA incluido) más gastos de transporte en el caso de análisis del defecto en las instalaciones de TRES COMERCIAL S.A.
- Tarifa oficial del Servicio Técnico (a disposición de los clientes a través del dpto. Comercial) en caso de atención por parte del Servicio Técnico en la instalación.

La Garantía Comercial cubre únicamente la reparación o reposición del material sin cargo alguno para el cliente, y sin que en ningún caso podamos hacernos responsables de los daños y perjuicios que por su defecto haya podido producirse directa o indirectamente.

Pago

El importe de las facturas, salvo acuerdos especiales, será cancelado mediante giro SEPA B2B como máximo a 30 días fecha factura.

Reserva de dominio

TRES COMERCIAL SA será propietario de todos los productos suministrados al cliente, hasta el cobro completo de la factura correspondiente.

MUY IMPORTANTE

Devoluciones

TRES COMERCIAL SA no aceptará ninguna devolución de mercancía sin que previamente nuestro representante lo haya aceptado y comunicado.

- 1) TRES COMERCIAL SA no acepta ninguna devolución sin la aceptación previa (la mercancía se devolverá al remitente).
- 2) TRES COMERCIAL SA no acepta ninguna devolución de mercancía que pueda repararse con recambios originales.
- 3) TRES COMERCIAL SA no acepta ninguna devolución de mercancía fuera de garantía.
- 4) No obstante, en caso de recepcionar mercancía perfectamente encajada, esta sufrirá una depreciación en factura de:
 - Si es del año en curso: *-15% depreciación*
 - Si es anterior a dos años: *-30% depreciación*
 - Si es anterior a 3 años: *-60% depreciación*

Los envíos de mercaderías deberán efectuarse a portes pagados por el cliente.



TRÈS

www.tresgriferia.com

C/ Penedès, 16-26
Zona Industrial, Sector A
08759 Vallirana (Barcelona)

España

comercial@tresgriferia.com
+34 93 683 40 27

Portugal

portugal@tresgriferia.com
+351 707 502 134



sat@tresgriferia.com
+34 93 683 41 34

AENOR

GESTIÓN
DE LA CALIDAD
ISO 9001

ER-1111/1999



8 429546 574011

REF. 7342023010 / ED. 01-2023