

**ÚNICO  
SENCILLO Y  
PRÁCTICO**

**IMEX**  
BATH EQUIPMENTS



2023 AVANCE

# IMEX BATH EQUIPMENTS

---



Imex Products, S.L.

Imex es una empresa ubicada en Picassent (Valencia) dedicada a la fabricación y comercialización de barras de ducha y griferías. Empezamos nuestra andadura en el año 2001, suministrando materiales de baño y duchas a empresas fabricantes del sector.

Con el paso de los años y la experiencia acumulada hemos desarrollado una serie de productos con un diseño y un precio muy competitivo en el mercado.

Nuestros productos son de gama media – alta, utilizando siempre las mejores materias primas que se encuentran en el mercado, como latón de primera calidad o acero S304 y S316, que nos han hecho tener representación en el territorio nacional e internacional. En Imex intentamos siempre estar a la cabeza del diseño, por eso se apuesta por el I+D+I constantemente.

Nuestros valores como empresa son, la fabulosa relación calidad – diseño y precio. Y nuestros compromisos con los clientes son los siguientes:

- Conseguir los más altos estándares de calidad
- Tener presente que el cliente es nuestra primera preocupación y su satisfacción nuestro principal objetivo.
- Rodearnos de grandes profesionales

Para todo ello intentamos adoptar una posición de mejora continua e innovación.

El resultado de todo esto se ve reflejado en el catálogo que le mostramos a continuación.





**MONZA** SERIE  
**CROMO**





# MONZA

## CROMO

SERIE



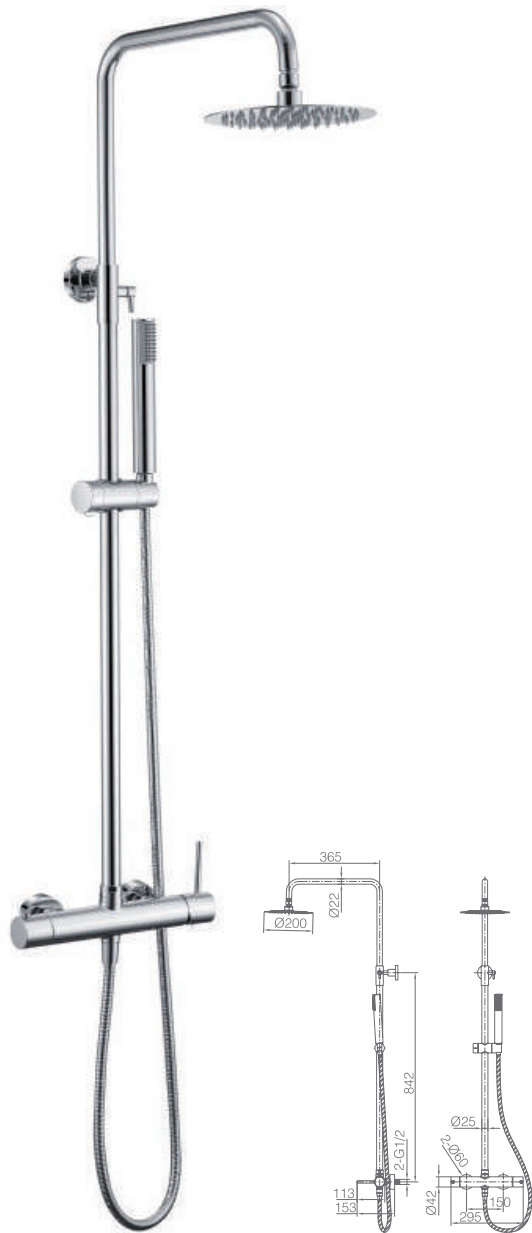

Ref.: **BDM039**

- Barra de ducha de acero inox. S.304 redonda extensible de 88/124 cm. cromo.
- Rociador de acero inox. S.304 Ø20cm, extraplano, cromo y antical.
- Soporte mango de ducha regulable en altura cromo.
- Mango de ducha redondo de 1 posición cromo.
- Grifería monomando de latón cromo con distribuidor incorporado.
- Caudal medio 12 l/min.
- Flexo PVC 150cm.
- Cartucho monomando cerámico Ø35 mm.

Grifería con certificación



Ref.: **BTM039**

- Barra de ducha de acero inox. S.304, redonda extensible de 88/124 cm. cromo.
- Rociador de acero inox. S.304 Ø20cm, extraplano, cromo y antical.
- Soporte mango de ducha regulable en altura cromo.
- Mango de ducha redondo de 1 posición cromo.
- Grifería termostática de latón cromo con distribuidor incorporado.
- Caudal medio 12 l/min.
- Flexo PVC 150cm.
- Cartucho termostático autolimpiante TURN CLEAN SYSTEM (patentado).

Grifería con certificación



# MONZA

## CROMO

SERIE

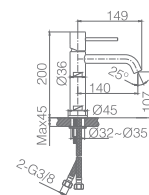

Ref.: **BDM039-1**

Monomando de lavabo.  
Cuerpo de grifería en latón.  
Acabado cromo.  
Cartucho cerámico Ø 25 mm.  
Flexos 3/8"

Grifería con certificación

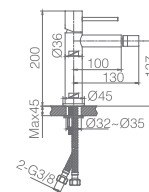

Ref.: **BDM039-2**

Monomando de bidé.  
Cuerpo de grifería en latón.  
Acabado cromo.  
Cartucho cerámico Ø 25 mm.  
Flexos 3/8"

Grifería con certificación

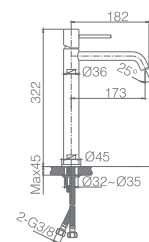

Ref.: **BDM039-3**

Monomando de lavabo.  
Cuerpo de grifería en latón.  
Acabado cromo.  
Cartucho cerámico Ø 25 mm.  
Flexos 3/8"

Grifería con certificación







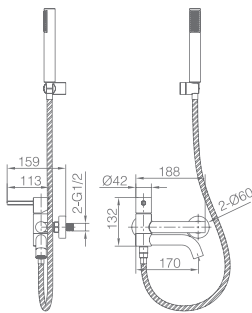

Ref.: **BDM039-4**

Grifería para baño/ducha en latón.  
Acabado cromo.  
Soporte para mango de ducha de ABS.  
Mango ducha redondo 1 posición.  
Flexo reforzado 180cm.  
Inversor caño abatible.  
Caudal medio 12 l/min.  
Cartucho monomando cerámico Ø 35mm.



Grifería con  
certificación  
**ACS**

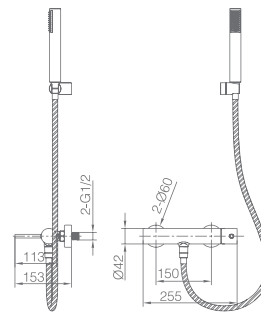

Ref.: **BDM039-5**

Grifería para ducha en latón.  
Acabado cromo.  
Soporte para mango de ducha de ABS.  
Mango ducha redondo 1 posición.  
Flexo reforzado 180cm.  
Caudal medio 12 l/min.  
Cartucho monomando cerámico Ø 35mm.



Grifería con  
certificación  
**ACS**

# MONZA

## CROMO

SERIE







PROFESSIONAL  
**IMEX**  
DESIGN



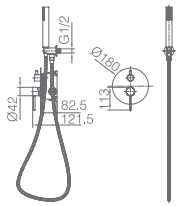
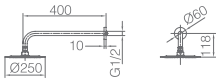

**Ref.: GPM039**

Rociador de acero inox. S.304 Ø25cm, extraplano, cromado y antical.  
 Tubo salida pared de latón cromado.  
 Mango de ducha redondo de 1 posición.  
 Grifería monomando de latón cromado de 2 vías.  
 Caudal medio 20 l/min.  
 Distribuidor redondo de latón.  
 Flexo PVC 150cm.  
 Cartucho monomando Ø 35 mm.  
 Soporte mango de ducha con salida agua pared.  
 Cuerpo empotrado a pared con caja de registro.

Grifería con certificación



**Ref.: GPT039**

Opcion tubo salida techo de latón cromado.

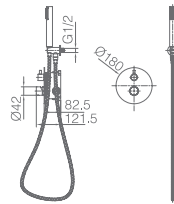
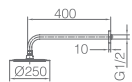

**Ref.: GTM039**

Rociador de acero inox. S.304 Ø25cm, extraplano, cromado y antical.  
 Tubo salida pared de latón cromado.  
 Mango de ducha cromado redondo de 1 posición.  
 Grifería termostática de latón cromado de 2 vías.  
 Caudal medio 20 l/min.  
 Distribuidor redondo de latón cromado.  
 Flexo PVC 150cm.  
 Cartucho termostático TURN CLEAN SYSTEM  
 Soporte mango de ducha cromado con salida agua pared.  
 Cuerpo empotrado a pared con caja de registro.

Grifería con certificación



**Ref.: GTT039**

Opcion tubo salida techo de latón cromado.



# MONZA

## CROMO

SERIE



Ref.: **GLM039**

Grifería empotrada monomando  
Latón cromado.  
En dos partes independientes.  
Cuerpo empotrado directo a pared.  
Sin caja de registro.

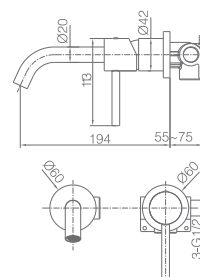





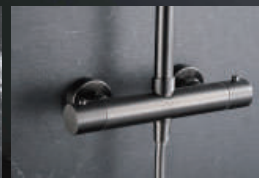
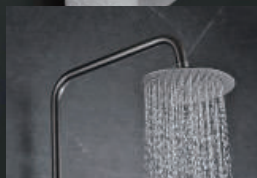

**MONZA** SERIE  
BLACK GUN METAL

# MONZA

BLACK GUN METAL  
SERIE







Ref.: **BDM039/BGM**

- Barra de ducha de acero inox. S.304 redonda extensible de 88/124 cm. acabado black gun metal.
- Rociador de acero inox. S.304 Ø20cm, extraplano, acabado black gun metal y antical.
- Soporte mango de ducha regulable en altura acabado black gun metal.
- Mango de ducha redondo de 1 posición acabado black gun metal.
- Grifería monomando de latón acabado black gun metal con distribuidor incorporado.
- Caudal medio 12 l/min.
- Flexo PVC 150cm.
- Cartucho monomando cerámico Ø35 mm.

Grifería con certificación



Ref.: **BTM039/BGM**

- Barra de ducha de acero inox. S.304, redonda extensible de 88/124 cm. black gun metal.
- Rociador de acero inox. S.304 Ø20cm, extraplano, black gun metal y antical.
- Soporte mango de ducha regulable en altura black gun metal.
- Mango de ducha redondo de 1 posición black gun metal.
- Grifería termostática de latón black gun metal con distribuidor incorporado.
- Caudal medio 12 l/min.
- Flexo PVC 150cm.
- Cartucho termostático autolimpiante TURN CLEAN SYSTEM (patentado).

Grifería con certificación



# MONZA

## BLACK GUN METAL

SERIE

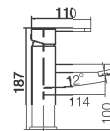

Ref.: **BDM039-1BGM**

Monomando de lavabo.  
Cuerpo de grifería en latón.  
Acabado black gun metal  
Cartucho cerámico Ø 25 mm.  
Flexos 3/8"

Grifería con certificación

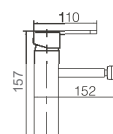

Ref.: **BDM039-2BGM**

Monomando de bidé.  
Cuerpo de grifería en latón.  
Acabado black gun metal  
Cartucho cerámico Ø 25 mm.  
Flexos 3/8"

Grifería con certificación

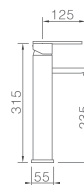

Ref.: **BDM039-3BGM**

Monomando de lavabo.  
Cuerpo de grifería en latón.  
Acabado black gun metal.  
Cartucho cerámico Ø 25 mm.  
Flexos 3/8"

Grifería con certificación



# MONZA

## BLACK GUN METAL

SERIE



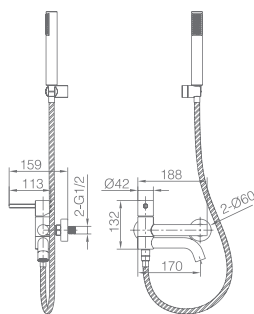
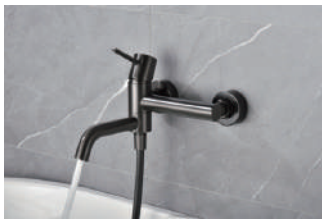

Ref.: **BDM039-4BGM**

Grifería para baño/ducha en latón.  
 Acabado black gun metal.  
 Soporte para mango de ducha de ABS.  
 Mango ducha redondo 1 posición.  
 Flexo PVC 180cm.  
 Inversor caño abatible.  
 Caudal medio 12 l/min.  
 Cartucho monomando cerámico Ø 35mm.



Grifería con  
certificación

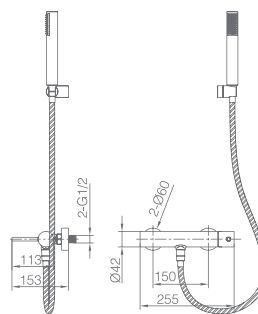

Ref.: **BDM039-5BGM**

Grifería para ducha en latón.  
 Acabado black gun metal.  
 Soporte para mango de ducha de ABS.  
 Mango ducha redondo 1 posición.  
 Flexo PVC 180cm.  
 Caudal medio 12 l/min.  
 Cartucho monomando cerámico Ø 35mm.



Grifería con  
certificación







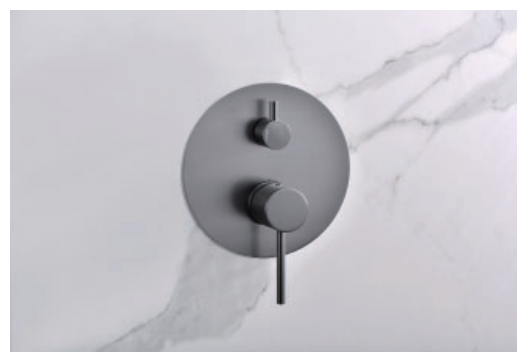

# MONZA

BLACK GUN METAL

SERIE





PVD

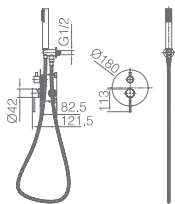
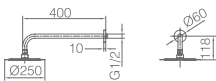

Ref.: **GPM039/BGM**

Rociador de acero inox. S.304 Ø25cm, extraplano, black gun metal y antical.  
 Tubo salida pared de latón black gun metal.  
 Mango de ducha black gun metal redondo de 1 posición.  
 Grifería monomando de latón black gun metal de 2 vías.  
 Caudal medio 20 l/min.  
 Distribuidor redondo de latón black gun metal.  
 Flexo PVC 150cm black gun metal  
 Cartucho monomando Ø 35 mm.  
 Soporte mango de ducha black gun metal con salida agua pared.  
 Cuerpo empotrado a pared con caja de registro.



Ref.: **GPT039/BGM**

Opcion tubo salida techo de latón acabado black gun metal..

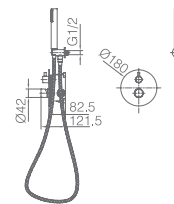
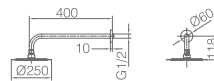

Ref.: **GTM039/BGM**

Rociador de acero inox. S.304 Ø25cm, extraplano, black gun metal y antical.  
 Tubo salida pared de latón black gun metal.  
 Mango de ducha black gun metal redondo de 1 posición.  
 Grifería termostática de latón black gun metal de 2 vías.  
 Caudal medio 20 l/min.  
 Distribuidor redondo de latón black gun metal.  
 Flexo PVC 150cm black gun metal.  
 Cartucho termostático TURN CLEAN SYSTEM  
 Soporte mango de ducha black gun metal con salida agua pared.  
 Cuerpo empotrado a pared con caja de registro.



Ref.: **GTT039/BGM**

Opcion tubo salida techo de latón acabado black gun metal..

# MONZA

## BLACK GUN METAL

SERIE



Ref.: **GLM039/BGM**

Grifería empotrada monomando  
Latón acabado black gun metal.  
En dos partes independientes.  
Cuerpo empotrado directo a pared.  
Sin caja de registro.

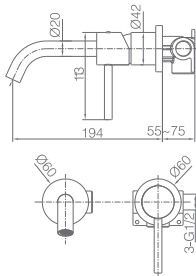





**MONZA** SERIE  
**NEGRO MATE**







# MONZA

NEGRO MATE

SERIE

ELECTROFÓRESIS

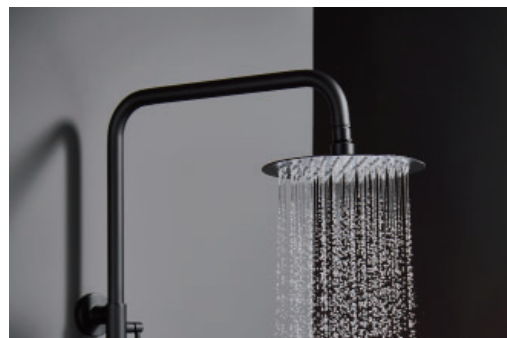



Ref.: **BDM039/NG**

- Barra de ducha de acero inox. S.304 redonda extensible de 88/124 cm. acabado negro mate.
- Rociador de acero inox. S.304 Ø20cm, extraplano, acabado negro mate y antical.
- Soporte mango de ducha regulable en altura acabado negro mate.
- Mango de ducha redondo de 1 posición acabado negro mate.
- Grifería monomando de latón acabado negro mate con distribuidor incorporado.
- Caudal medio 12 l/min.
- Flexo PVC 150cm.
- Cartucho monomando cerámico Ø35 mm.

Grifería con certificación



Ref.: **BTM039/NG**

- Barra de ducha de acero inox. S.304, redonda extensible de 88/124 cm. negro mate.
- Rociador de acero inox. S.304 Ø20cm, extraplano, negro mate y antical.
- Soporte mango de ducha regulable en altura negro mate.
- Mango de ducha redondo de 1 posición negro mate.
- Grifería termostática de latón negro mate con distribuidor incorporado.
- Caudal medio 12 l/min.
- Flexo PVC 150cm.
- Cartucho termostático autolimpiable TURN CLEAN SYSTEM (patentado).

Grifería con certificación



# MONZA

NEGRO MATE

SERIE

ELECTROFÓRESIS



Ref.: **BDM039-1NG**

Monomando de lavabo.  
Cuerpo de grifería en latón.  
Acabado negro mate.  
Cartucho cerámico Ø 25 mm.  
Flexos 3/8"

Grifería con certificación  
**ACS** **5 YEARS**



Ref.: **BDM039-2NG**

Monomando de bidé.  
Cuerpo de grifería en latón.  
Acabado negro mate.  
Cartucho cerámico Ø 25 mm.  
Flexos 3/8"

Grifería con certificación  
**ACS** **5 YEARS**



Ref.: **BDM039-3NG**

Monomando de lavabo alto.  
Cuerpo de grifería en latón.  
Acabado negro mate.  
Cartucho cerámico Ø 25 mm.  
Flexos 3/8"

Grifería con certificación  
**ACS** **5 YEARS**

# MONZA

## NEGRO MATE

SERIES

ELECTROFÓRESIS



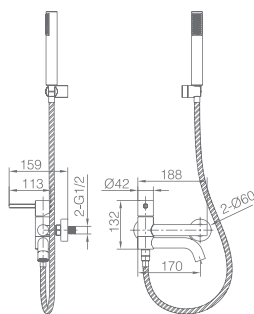

Ref.: **BDM039-4NG**

Grifería para baño/ducha en latón.  
 Acabado negro mate.  
 Soporte para mango de ducha de ABS.  
 Mango ducha redondo 1 posición.  
 Flexo PVC 180cm.  
 Inversor caño abatible.  
 Caudal medio 12 l/min.  
 Cartucho monomando cerámico Ø 35mm.

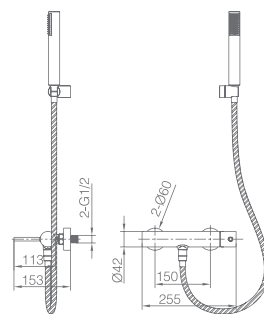
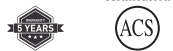

Ref.: **BDM039-5NG**

Grifería para ducha en latón.  
 Acabado negro mate.  
 Soporte para mango de ducha de ABS.  
 Mango ducha redondo 1 posición.  
 Flexo PVC 180cm.  
 Caudal medio 12 l/min.  
 Cartucho monomando cerámico Ø 35mm.











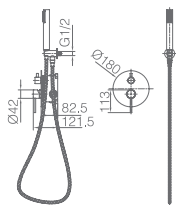
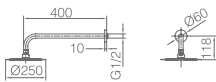

Ref.: **GPM039/NG**

Rociador de acero inox. S.304 Ø25cm, extraplano, negro mate y antical.  
 Tubo salida pared de latón negro mate.  
 Mango de ducha negro mate redondo de 1 posición.  
 Grifería monomando de latón negro mate de 2 vías.  
 Caudal medio 20 l/min.  
 Distribuidor redondo de latón negro mate  
 Flexo PVC 150cm negro mate  
 Cartucho monomando Ø 35 mm.  
 Soporte mango de ducha negro mate con salida agua pared.  
 Cuerpo empotrado a pared con caja de registro.



Ref.: **GPT039/NG**

Opcion tubo salida techo de latón acabado negro mate.

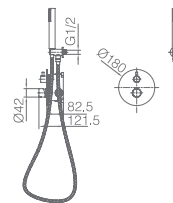
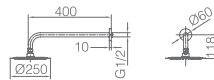

Ref.: **GTM039/NG**

Rociador de acero inox. S.304 Ø25cm, extraplano, negro mate y antical.  
 Tubo salida pared de latón negro mate.  
 Mango de ducha negro mate redondo de 1 posición.  
 Grifería termostática de latón negro mate de 2 vías.  
 Caudal medio 20 l/min.  
 Distribuidor redondo de latón negro mate.  
 Flexo PVC 150cm negro mate.  
 Cartucho termostático TURN CLEAN SYSTEM  
 Soporte mango de ducha negro mate con salida agua pared.  
 Cuerpo empotrado a pared con caja de registro.



Ref.: **GTT039/NG**

Opcion tubo salida techo de latón acabado negro mate.



# MONZA

## NEGRO MATE

SERIE

ELECTROFÓRESIS



Ref: **GLM039/NG**

Grifería empotrada monomando  
Latón acabado negro mate.  
En dos partes independientes.  
Cuerpo empotrado directo a pared.  
Sin caja de registro.

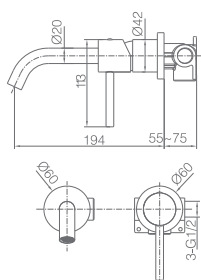

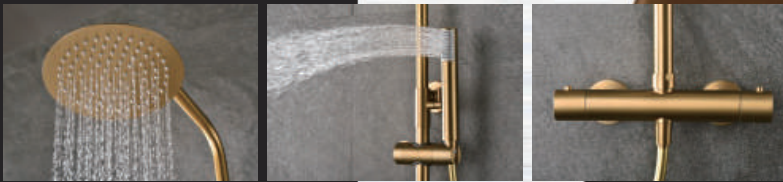

**MONZA** SERIE  
**ORO CEPILLADO**





# MONZA

ORO CEPILLADO

SERIE

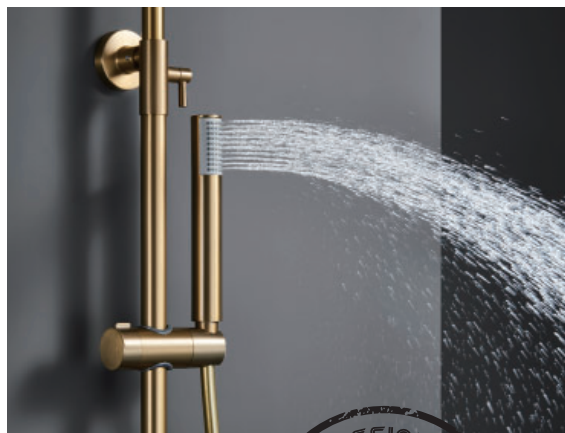



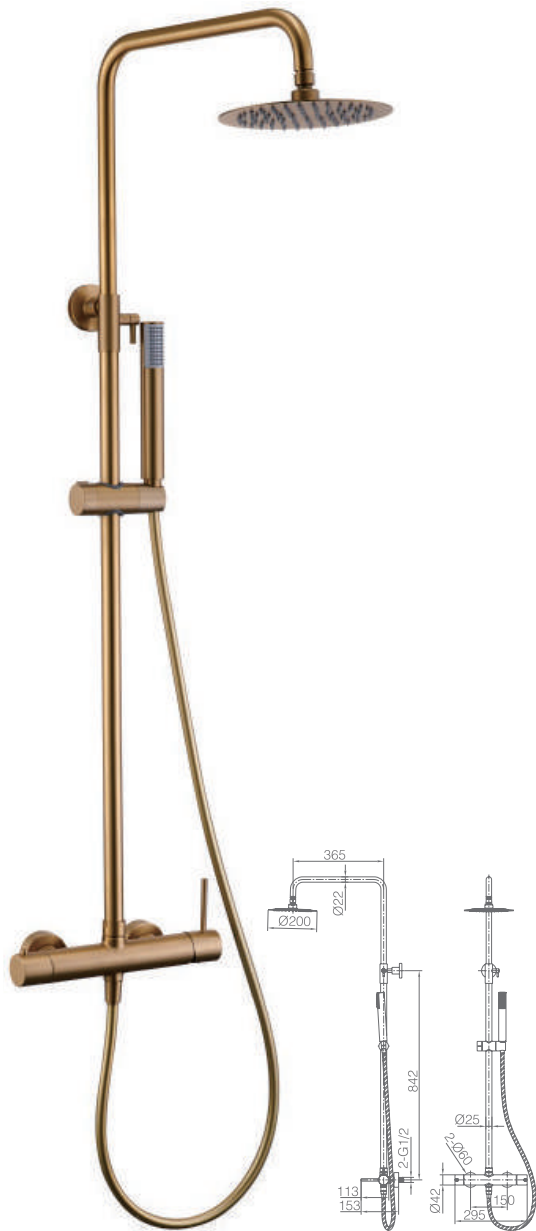

Ref.: **BDM039/OC**

- Barra de ducha de acero inox. S.304 redonda extensible de 88/124 cm. acabado oro cepillado.
- Rociador de acero inox. S.304 Ø20cm, extraplano, acabado oro cepillado y antical.
- Soporte mango de ducha regulable en altura acabado oro cepillado.
- Mango de ducha redondo de 1 posición acabado oro cepillado.
- Grifería monomando de latón acabado oro cepillado con distribuidor incorporado.
- Caudal medio 12 l/min.
- Flexo PVC 150cm.
- Cartucho monomando cerámico Ø35 mm.

Grifería con certificación



Ref.: **BTM039/OC**

- Barra de ducha de acero inox. S.304, redonda extensible de 88/124 cm. oro cepillado.
- Rociador de acero inox. S.304 Ø20cm, extraplano, oro cepillado y antical.
- Soporte mango de ducha regulable en altura oro cepillado.
- Mango de ducha redondo de 1 posición oro cepillado.
- Grifería termostática de latón oro cepillado con distribuidor incorporado.
- Caudal medio 12 l/min.
- Flexo PVC 150cm.
- Cartucho termostático autolimpiable TURN CLEAN SYSTEM (patentado).

Grifería con certificación



# MONZA

## ORO CEPILLADO

SERIE

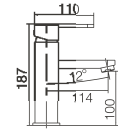

Ref.: **BDM039-10C**

Monomando de lavabo.  
Cuerpo de grifería en latón.  
Acabado oro cepillado.  
Cartucho cerámico Ø 25 mm.  
Flexos 3/8"

Grifería con certificación

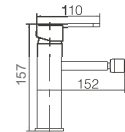

Ref.: **BDM039-20C**

Monomando de bidé.  
Cuerpo de grifería en latón.  
Acabado oro cepillado.  
Cartucho cerámico Ø 25 mm.  
Flexos 3/8"

Grifería con certificación

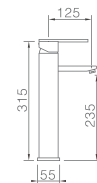

Ref.: **BDM039-30C**

Monomando de lavabo alto.  
Cuerpo de grifería en latón.  
Acabado oro cepillado.  
Cartucho cerámico Ø 25 mm.  
Flexos 3/8"

Grifería con certificación





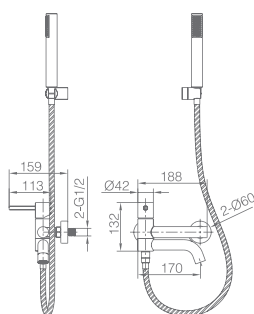

Ref.: **BDM039-40C**

Grifería para baño/ducha en latón.  
 Acabado oro cepillado.  
 Soporte para mango de ducha de ABS.  
 Mango ducha redondo 1 posición.  
 Flexo PVC 180cm.  
 Inversor caño abatible.  
 Caudal medio 12 l/min.  
 Cartucho monomando cerámico Ø 35mm.



Grifería con certificación

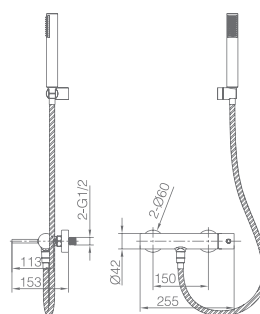

Ref.: **BDM039-50C**

Grifería para ducha en latón.  
 Acabado oro cepillado.  
 Soporte para mango de ducha de ABS.  
 Mango ducha redondo 1 posición.  
 Flexo PVC 180cm.  
 Caudal medio 12 l/min.  
 Cartucho monomando cerámico Ø 35mm.



Grifería con certificación

# MONZA

## ORO CEPILLADO

SERIE

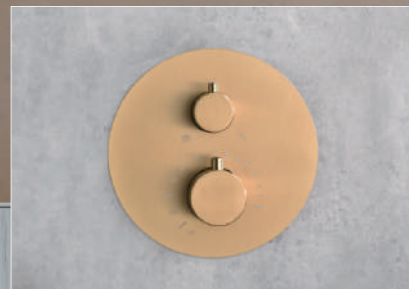
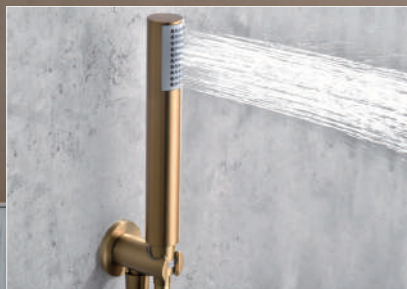





PVD



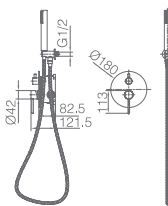
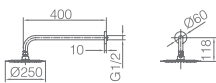

Ref.: **GPM039/OC**

Rociador de acero inox. S.304 Ø25cm, extraplano, oro cepillado y antical.  
 Tubo salida pared de latón oro cepillado.  
 Mango de ducha oro cepillado redondo de 1 posición.  
 Grifería monomando de latón oro cepillado de 2 vías.  
 Caudal medio 20 l/min.  
 Distribuidor redondo de latón oro cepillado.  
 Flexo PVC 150cm oro cepillado  
 Cartucho monomando Ø 35 mm.  
 Soporte mango de ducha oro cepillado con salida agua pared.  
 Cuerpo empotrado a pared con caja de registro.



Ref.: **GPT039/OC**

Opcion tubo salida techo de latón acabado oro cepillado.

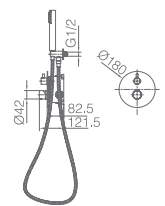
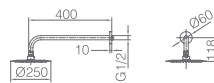

Ref.: **GTM039/OC**

Rociador de acero inox. S.304 Ø25cm, extraplano, oro cepillado y antical.  
 Tubo salida pared de latón oro cepillado.  
 Mango de ducha oro cepillado redondo de 1 posición.  
 Grifería termostática de latón oro cepillado de 2 vías.  
 Caudal medio 20 l/min.  
 Distribuidor redondo de latón oro cepillado.  
 Flexo PVC 150cm oro cepillado.  
 Cartucho termostático TURN CLEAN SYSTEM  
 Soporte mango de ducha oro cepillado con salida agua pared.  
 Cuerpo empotrado a pared con caja de registro.



Ref.: **GTT039/OC**

Opcion tubo salida techo de latón acabado oro cepillado.





# MONZA

## ORO CEPILLADO

SERIE



Ref: **GLM039/OC**

Grifería empotrada monomando  
 Latón acabado oro cepillado.  
 En dos partes independientes.  
 Cuerpo empotrado directo a pared.  
 Sin caja de registro.

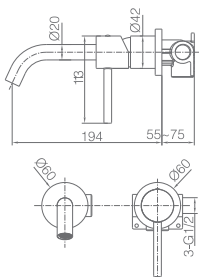





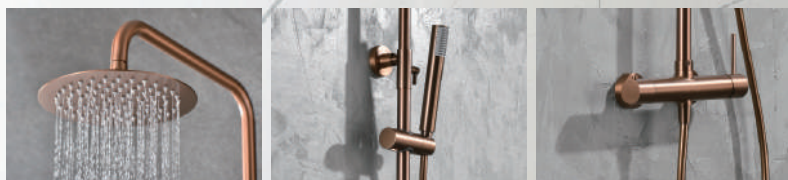

**MONZA** SERIE  
ORO ROSA CEPILLADO

# MONZA

ORO ROSA CEPILLADO

SERIE





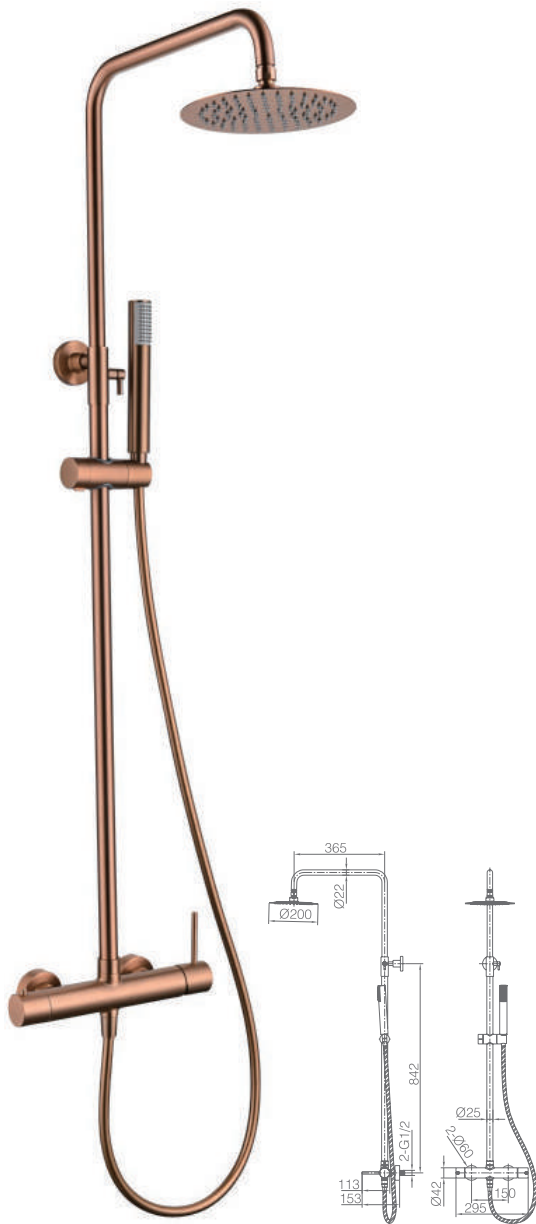

Ref.: **BDM039/ORC**

- Barra de ducha de acero inox. S.304 redonda extensible de 88/124 cm. acabado oro rosa cepillado.
- Rociador de acero inox. S.304 Ø20cm, extraplano, acabado oro rosa cepillado y antical.
- Soporte mango de ducha regulable en altura acabado oro rosa cepillado.
- Mango de ducha redondo de 1 posición acabado oro rosa cepillado.
- Grifería monomando de latón acabado oro rosa cepillado con distribuidor incorporado.
- Caudal medio 12 l/min.
- Flexo PVC 150cm.
- Cartucho monomando cerámico Ø35 mm.

Grifería con certificación



Ref.: **BTM039/ORC**

- Barra de ducha de acero inox. S.304, redonda extensible de 88/124 cm. oro rosa cepillado.
- Rociador de acero inox. S.304 Ø20cm, extraplano, oro rosa cepillado y antical.
- Soporte mango de ducha regulable en altura oro rosa cepillado.
- Mango de ducha redondo de 1 posición oro rosa cepillado.
- Grifería termostática de latón oro rosa cepillado con distribuidor incorporado.
- Caudal medio 12 l/min.
- Flexo PVC 150cm.
- Cartucho termostático autolimpiante TURN CLEAN SYSTEM (patentado).

Grifería con certificación



# MONZA

## ORO ROSA CEPILLADO

SERIE

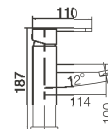

Ref.: **BDM039-1ORC**

Monomando de lavabo.  
Cuerpo de grifería en latón.  
Acabado oro rosa cepillado.  
Cartucho cerámico Ø 25 mm.  
Flexos 3/8"

Grifería con certificación

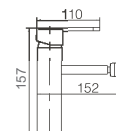

Ref.: **BDM039-2ORC**

Monomando de bidé.  
Cuerpo de grifería en latón.  
Acabado oro rosa cepillado.  
Cartucho cerámico Ø 25 mm.  
Flexos 3/8"

Grifería con certificación

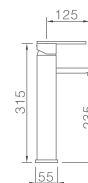

Ref.: **BDM039-3ORC**

Monomando de lavabo alto.  
Cuerpo de grifería en latón.  
Acabado oro rosa cepillado.  
Cartucho cerámico Ø 25 mm.  
Flexos 3/8"

Grifería con certificación







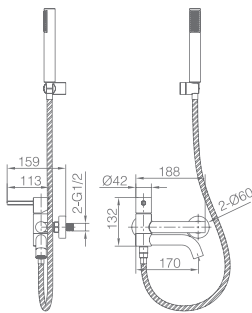

Ref.: **BDM039-4ORC**

Grifería para baño/ducha en latón.  
 Acabado oro rosa cepillado.  
 Soporte para mango de ducha de ABS.  
 Mango ducha redondo 1 posición.  
 Flexo PVC 180cm.  
 Inverso caño abatible.  
 Caudal medio 12 l/min.  
 Cartucho monomando cerámico Ø 35mm.

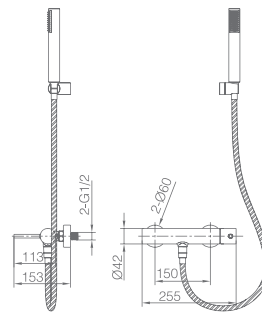
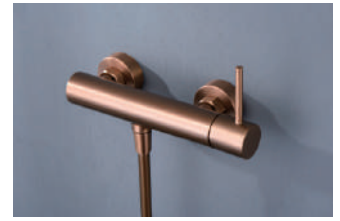

Ref.: **BDM039-5ORC**

Grifería para ducha en latón.  
 Acabado oro rosa cepillado.  
 Soporte para mango de ducha de ABS.  
 Mango ducha redondo 1 posición.  
 Flexo PVC 180cm.  
 Caudal medio 12 l/min.  
 Cartucho monomando cerámico Ø 35mm.



# MONZA

ORO ROSA CEPILLADO

SERIE

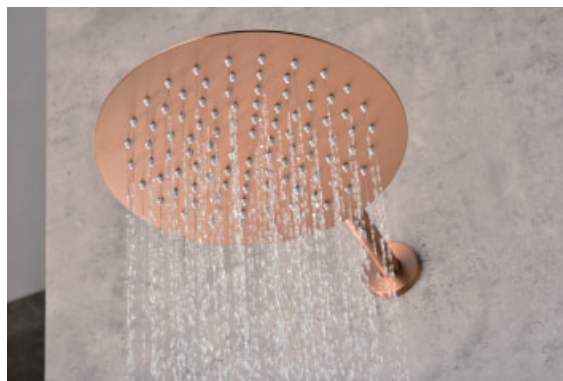





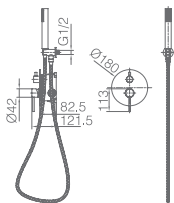
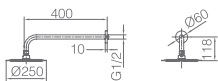
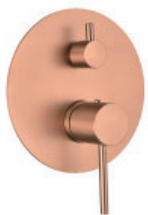

Ref.: **GPM039/ORC**

Rociador de acero inox. S.304 Ø25cm, extraplano, oro rosa cepillado y antical.  
 Tubo salida pared de latón oro rosa cepillado.  
 Mango de ducha oro rosa cepillado redondo de 1 posición.  
 Grifería monomando de latón oro rosa cepillado de 2 vías.  
 Caudal medio 20 l/min.  
 Distribuidor redondo de latón oro rosa cepillado.  
 Flexo PVC 150cm oro rosa cepillado.  
 Cartucho monomando Ø 35 mm.  
 Soporte mango de ducha oro rosa cepillado con salida agua pared.  
 Cuerpo empotrado a pared con caja de registro.

Grifería con certificación



Ref.: **GPT039/ORC**

Opcion tubo salida techo de latón acabado oro rosa cepillado.

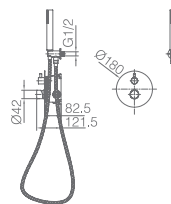
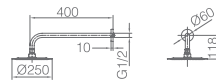
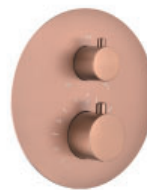

Ref.: **GTM039/ORC**

Rociador de acero inox. S.304 Ø25cm, extraplano, oro rosa cepillado y antical.  
 Tubo salida pared de latón oro rosa cepillado.  
 Mango de ducha oro rosa cepillado redondo de 1 posición.  
 Grifería termostática de latón oro rosa cepillado de 2 vías.  
 Caudal medio 20 l/min.  
 Distribuidor redondo de latón oro rosa cepillado.  
 Flexo PVC 150cm oro rosa cepillado.  
 Cartucho termostático TURN CLEAN SYSTEM  
 Soporte mango de ducha oro rosa cepillado con salida agua pared.  
 Cuerpo empotrado a pared con caja de registro.

Grifería con certificación



Ref.: **GTT039/ORC**

Opcion tubo salida techo de latón acabado oro rosa cepillado.

# MONZA

ORO ROSA CEPILLADO

SERIE





Ref.: **GLM039/ORC**

Grifería empotrada monomando  
Latón acabado oro rosa cepillado.  
En dos partes independientes.  
Cuerpo empotrado directo a pared.  
Sin caja de registro.

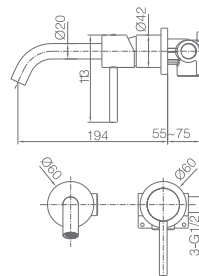



# MUNICH

SERIE  
BIDÉ EMPOTRADO





# MUNICH

## CROMO

SERIE



### Ref.: RDM001

Grifería empotrada de bidé.

Agua fría y caliente.

Mango de 1 posición.

Latón acabado cromo.

Flexo de acero reforzado de 100 cm antiexplosión.

Tapón especial pre-montaje en latón cromado, alta resistencia. Cuerpo con caja de registro.

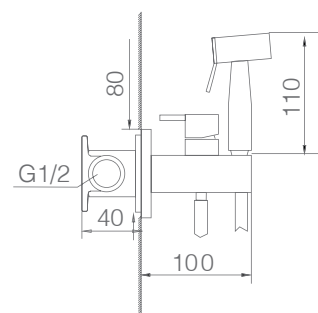



# MUNICH

## BLACK GUN METAL

SERIE



### Ref.: RDM001/BGM

Grifería empotrada de bidé.  
Agua fría y caliente.  
Mango de 1 posición.  
Latón acabado black gun metal.  
Flexo PVC de 100 cm antiexplosión.  
Tapón especial pre-montaje en latón cromado, alta resistencia. Cuerpo con caja de registro.

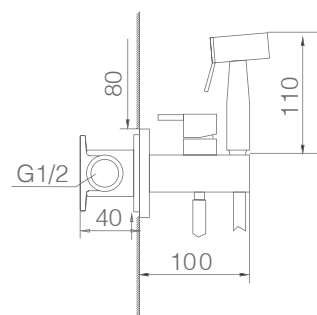

# MUNICH

## NEGRO MATE

SERIE

**ELECTROFÓRESIS**

### Ref.: RDM001/NG

Grifería empotrada de bidé.

Agua fría y caliente.

Mango de 1 posición.

Latón acabado negro mate.

Flexo PVC de 100 cm antiexplosión.

Tapón especial pre-montaje en latón cromado, alta resistencia. Cuerpo con caja de registro.

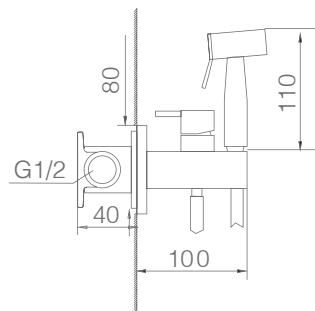







# MUNICH

## ORO CEPILLADO

SERIE

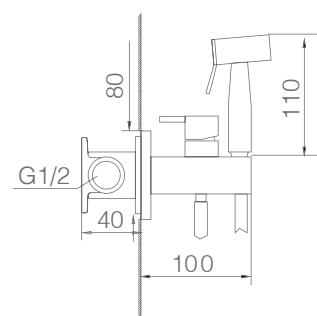

### Ref: RDM001/OC

Grifería empotrada de bidé.  
Agua fría y caliente.  
Mango de 1 posición.  
Latón acabado oro cepillado.  
Flexo PVC de 100 cm antiexplosión.  
Tapón especial pre-montaje en latón cromado, alta resistencia. Cuerpo con caja de registro.



# MUNICH

## ORO ROSA CEPILLADO

SERIE

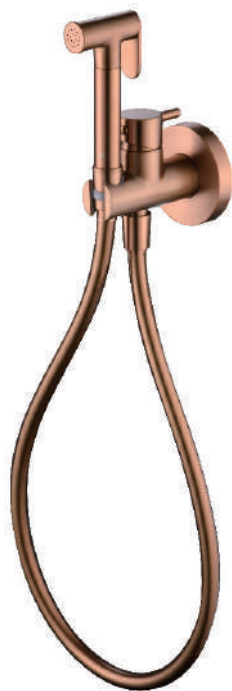

**Ref.: RDM001/ORC**

Grifería empotrada de bidé.  
Agua fría y caliente.  
Mango de 1 posición.  
Latón acabado oro rosa cepillado.  
Flexo PVC de 100 cm antiexplosión.  
Tapón especial pre-montaje en latón cromado, alta resistencia. Cuerpo con caja de registro.

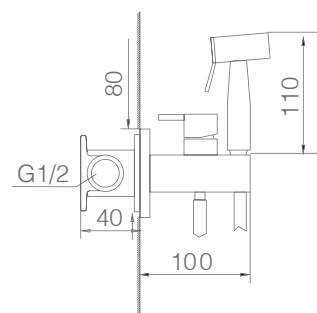



# CÓRCEGA

SERIE

GRIFERÍA EXENTA



# CÓRCEGA

## CROMO

SERIE

### Ref.: BBECO1

Grifería exenta de bañera en latón.  
Acabado cromo.  
Cartucho cerámico Ø35 mm.  
Mango de ducha redondo, 1 posición  
Flexo de pvc.  
Caja de registro a suelo.

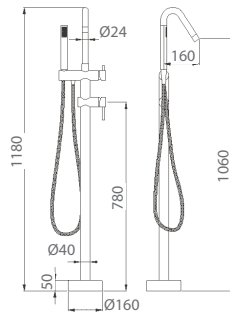









# CÓRCEGA

## NEGRO MATE

SERIE

ELECTROFÓRESIS

### Ref.: BBECO1/NG

Grifería exenta de bañera en latón  
Acabado negro mate.  
Cartucho cerámico Ø 35 mm.  
Mango de ducha redondo, 1 posición  
Flexo de PVC.  
Caja de registro a suelo.

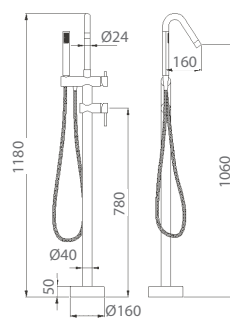



# CÓRCEGA

## ORO CEPILLADO

SERIE

### Ref.: BBECO1/OC

Grifería exenta de bañera en latón.  
Acabado oro cepillado.  
Cartucho cerámico Ø35 mm.  
Mango de ducha redondo, 1 posición  
Flexo de PVC.  
Caja de registro a suelo.

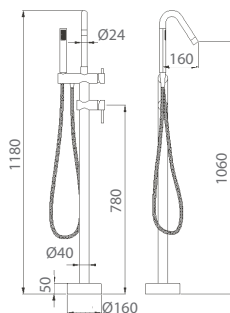





# CÓRCEGA

## ORO ROSA CEPILLADO

SERIE

Ref.: **BBECO1/ORC**

Grifería exenta de bañera en latón.  
Acabado oro rosa cepillado.  
Cartucho cerámico Ø35 mm.  
Mango de ducha redondo, 1 posición  
Flexo de PVC.  
Caja de registro a suelo.

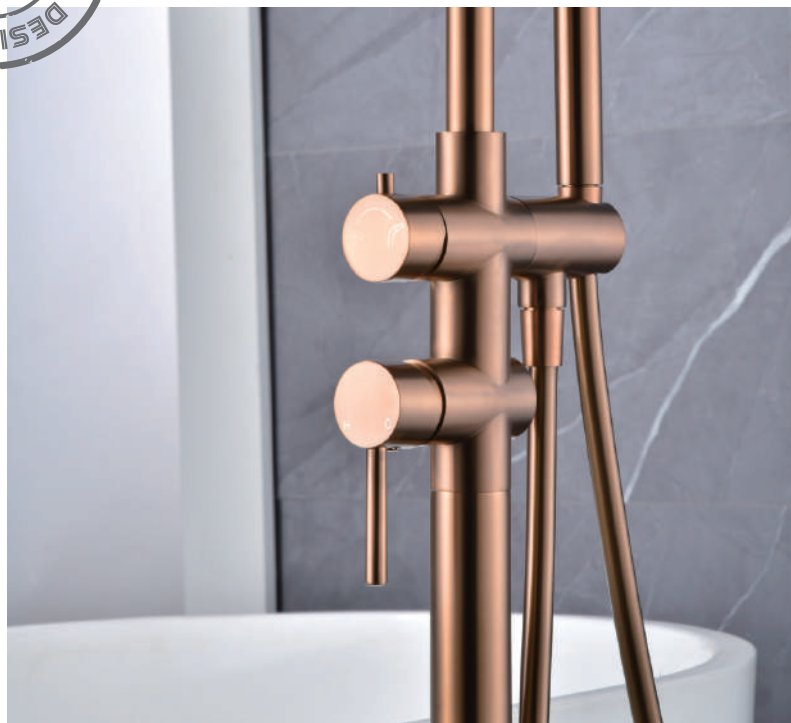
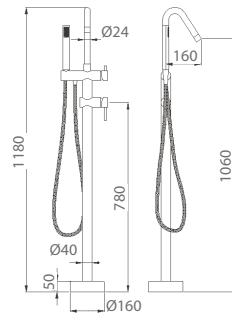



# COMPLEMENTOS

# VALVULAS

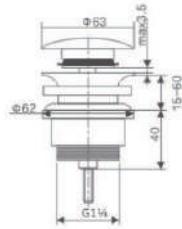

**Ref.: VCC001**

Apta para todos los lavabos y bidés, con o sin rebosadero.  
Sistema de apertura/cierre garantizado para ciclos de 20.000 usos.  
Rosca inferior de Ø1 ¼".  
Fabricadas en latón, cromado.  
Montaje rápido y sencillo.

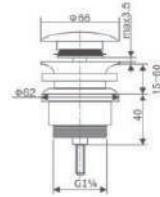

**Ref.: VCC008(negro mate)**

Apta para todos los lavabos y bidés, con o sin rebosadero.  
Sistema de apertura/cierre garantizado para ciclos de 20.000 usos.  
Rosca inferior de Ø1 ¼".  
Fabricadas en latón, negro mate.  
Montaje rápido y sencillo.

**SISTEMA LACADO  
ELECTROFORESIS**

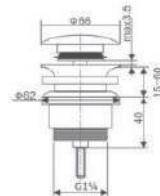

**Ref.: VCC014 (oro cepillado)**

PVD

Apta para todos los lavabos y bidés, con o sin rebosadero.  
Sistema de apertura/cierre garantizado para ciclos de 20.000 usos.  
Rosca inferior de Ø1 ¼".  
Fabricadas en latón y zamak.  
Acabado PVD oro cepillado.  
Montaje rápido y sencillo.

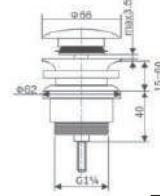

**Ref.: VCC023 (oro rosa cepillado)**

PVD

Apta para todos los lavabos y bidés, con o sin rebosadero.  
Sistema de apertura/cierre garantizado para ciclos de 20.000 usos.  
Rosca inferior de Ø1 ¼".  
Fabricadas en latón y zamak.  
Acabado PVD oro rosa cepillado.  
Montaje rápido y sencillo.

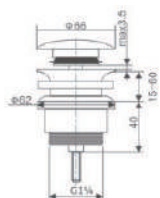

**Ref.: VCC018 (black gun metal)**

Apta para todos los lavabos y bidés, con o sin rebosadero.  
Sistema de apertura/cierre garantizado para ciclos de 20.000 usos.  
Rosca inferior de Ø1 ¼".  
Fabricadas en latón y zamak.  
Acabado PVD black gun metal.  
Montaje rápido y sencillo.

PVD



# VALVULAS (PVC)



SISTEMA LACADO  
ELECTROFORESIS

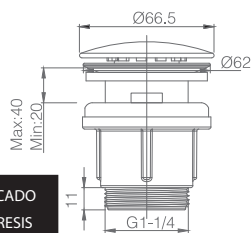

## Ref.: VCC019 (negro mate)

Apta para todos los lavabos y bidés, con o sin rebosadero.  
Sistema de apertura/cierre garantizado para ciclos de 20.000 usos.  
Rosca inferior de Ø1 ¼".  
Fabricadas en PVC y acero S304 acabado negro mate.  
Montaje rápido y sencillo.

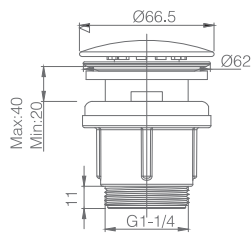

## Ref.: VCC0021 (oro rosa cepillado)

Apta para todos los lavabos y bidés, con o sin rebosadero.  
Sistema de apertura/cierre garantizado para ciclos de 20.000 usos.  
Rosca inferior de Ø1 ¼".  
Fabricadas en PVC y acero S304 acabado oro rosa cepillado.  
Montaje rápido y sencillo.

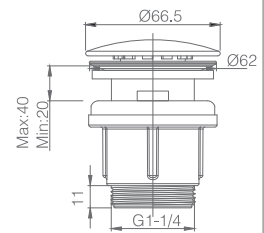

## Ref.: VCC020 (oro cepillado)

Apta para todos los lavabos y bidés, con o sin rebosadero.  
Sistema de apertura/cierre garantizado para ciclos de 20.000 usos.  
Rosca inferior de Ø1 ¼".  
Fabricadas en PVC y acero S304 acabado oro cepillado.  
Montaje rápido y sencillo.

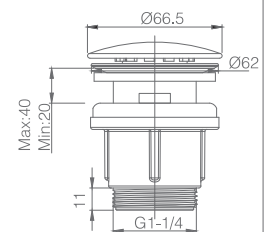

## Ref.: VCC022 (black gun metal)

Apta para todos los lavabos y bidés, con o sin rebosadero.  
Sistema de apertura/cierre garantizado para ciclos de 20.000 usos.  
Rosca inferior de Ø1 ¼".  
Fabricadas en PVC y acero S304 acabado black gun metal.  
Montaje rápido y sencillo.

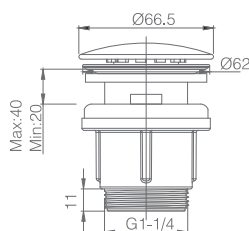

## Ref.: VCC009

Apta para todos los lavabos y bidés, con o sin rebosadero.  
Sistema de apertura/cierre garantizado para ciclos de 20.000 usos.  
Rosca inferior de Ø1 ¼".  
Fabricadas en PVC y acero S304 acabado cromado.  
Montaje rápido y sencillo.



# SIFONES



Ref.: **SCL002**

Sifon visto redondo cromado  
Base desmontable, fácil limpieza.  
Material : Acero s304 y zamak  
Acababo : Cromado



Ref.: **SCL002/BGM**

Sifon visto redondo  
Base desmontable, fácil limpieza.  
Material : Acero s304 y zamak  
Acababo : Black gun metal



Ref.: **SCL002/ORC**

Sifon visto redondo  
Base desmontable, fácil limpieza.  
Material : Acero s304 y zamak  
Acababo : Oro rosa cepillado



**ELECTROFORESIS**

Ref.: **SCL002/NG**

Sifon visto redondo negro mate  
Base desmontable, fácil limpieza.  
Material : Acero s304 y zamak  
Acababo : Negro mate



Ref.: **SCL002/OC**

Sifon visto redondo  
Base desmontable, fácil limpieza.  
Material : Acero s304 y zamak  
Acababo : Oro cepillado

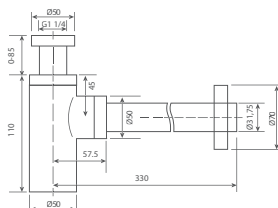

Ref.: **1EXP002-B**

# CONDICIONES GENERALES DE VENTA

## ENTREGAS

Revise la mercancía a la recepción de la misma. No se aceptará ninguna reclamación sobre mercancía no revisada en el momento de su recepción. El transportista indicará tal efecto en el albarán de entrega.

## DEVOLUCIONES

En caso de devolución defina claramente el motivo de la misma.

IMEX aceptará toda devolución que cumpla las siguientes premisas:

-El material deberá tener algún defecto de fabricación.

-El embalaje deberá estar en perfecto estado, de no ser así se le aplicará un recargo de un 10% en factura en concepto de recepción, revisión y manipulación.

## FORMA DE PAGO

Se emitirá recibo a través de entidad bancaria.

Giro máximo 30 días fecha factura

Cualquier impago que se produzca conllevará el pago de la factura más todos los gastos bancarios ocasionados y retención de todos los pedidos hasta el pago del mismo.

## TRIBUNALES

En caso de litigio ambas partes se someterán a los tribunales de Picassent (VALENCIA).

## PORTES

Para los pedidos a entregar en la península que no superen los 80€, se cargarán 6,50 € de portes. Para otros destinos consultar con fábrica o comercial.

# ACTUALIZACIÓN Y MANTENIMIENTO DE LAS COLECCIONES

## CAMBIOS EN EL MODELAJE

En ciertas ocasiones, algunos de los artículos suministrados por IMEX PRODUCTS, S.L., pueden presentar cambios, no sustanciales, en algunos de sus componentes en relación a las fotografías publicadas en catálogo actual.

IMEX PRODUCTS, S.L. se reserva el derecho de efectuar dichos cambios en su modelaje siempre en aras de una mejora tanto del diseño y funcionalidad del producto, como de sus condiciones de venta.

# CONSEJOS DE LIMPIEZA Y MANTENIMIENTO

En Imex Products aconsejamos que para realizar la limpieza de nuestra grifería, en acabados negro mate o blanco mate, se utilicen productos no abrasivos y con un Ph neutro, evitando, de este modo, dañar las piezas.

Siguiendo las indicaciones o recomendaciones del fabricante del producto, aconsejamos la utilización de bayeta de microfibra en el proceso de limpieza, finalizando con el secado de las piezas. De esta forma conseguiremos alargar la vida de la grifería.

Video demostrativo



**IMEX**  
BATH EQUIPMENTS

IMEX PRODUCTS, S.L.

Pol. Ind. Picassent  
C/ 6 parcela 11  
46220 Picassent (Valencia)- Sapain  
C.I.F.:B-98301732

AT.CLIENT:  
Tel: +34 96 065 12 74  
Tel: +34 96 156 63 87  
Tel: +34 630 402 947

[www.imexproducts.es](http://www.imexproducts.es)



Mails:  
(Pedidos) [imex@imexproducts.es](mailto:imex@imexproducts.es)  
(Consultas) [consultas@imexproducts.es](mailto:consultas@imexproducts.es)  
(Servicio Técnico) [sat@imexproducts.es](mailto:sat@imexproducts.es)  
(Exportación) [export@imexproducts.es](mailto:export@imexproducts.es)

ÚNICO, SENCILLO  
Y PRÁCTICO

2022 - 2023 CATÁLOGO



**IMEX**

BATH EQUIPMENTS

EDICIÓN COCINAS

# IMEX GRIFERÍA DE COCINA

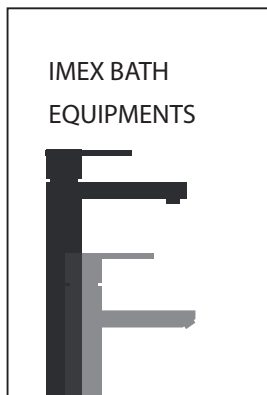

Imex Products, S.L.

Imex es una empresa ubicada en Picassent, (Valencia) dedicada a la fabricación y comercialización de barras de ducha y griferías. Empezamos nuestra andadura en el año 2001, suministrando materiales de baño y duchas a empresas fabricantes del sector.

Con el paso de los años y la experiencia acumulada hemos desarrollado una serie de productos con un diseño y un precio muy competitivo en el mercado.

Nuestros productos son de gama media – alta, utilizando siempre las mejores materias primas que se encuentran en el mercado, como latón de primera calidad o acero S304 y S316, que nos han hecho tener representación en el territorio nacional e internacional.

En Imex intentamos siempre estar a la cabeza del diseño, por eso se apuesta por el I+D+I constantemente.

Nuestros valores como empresa son, la fabulosa relación calidad – diseño y precio. Y nuestros compromisos con los clientes son los siguientes:

- Conseguir los más altos estándares de calidad
- Tener presente que el cliente es nuestra primera preocupación y su satisfacción nuestro principal objetivo.
- Rodearnos de grandes profesionales

Para todo ello intentamos adoptar una posición de mejora continua e innovación.

El resultado de todo esto se ve reflejado en el catálogo que le mostramos a continuación.



































REDONDOS

GRIFERÍA DE COCINA

	Cocina	Extraíble	Flexible	Ósmosis
<b>LANZAROTE</b>			128	
	<input type="checkbox"/>	<input type="checkbox"/>	<input type="checkbox"/>	<input type="checkbox"/>
	<input type="checkbox"/>	<input type="checkbox"/>	<input type="checkbox"/>	<input type="checkbox"/>
	<input type="checkbox"/>	<input type="checkbox"/>	<input type="checkbox"/>	<input type="checkbox"/>
	<input type="checkbox"/>	<input type="checkbox"/>	<input type="checkbox"/>	<input type="checkbox"/>
	<input type="checkbox"/>	<input type="checkbox"/>	<input type="checkbox"/>	<input type="checkbox"/>
	<input type="checkbox"/>	<input type="checkbox"/>	<input type="checkbox"/>	<input type="checkbox"/>
	<input type="checkbox"/>	<input type="checkbox"/>	<input type="checkbox"/>	<input type="checkbox"/>
	<input type="checkbox"/>	<input type="checkbox"/>	<input type="checkbox"/>	<input type="checkbox"/>
	<input type="checkbox"/>	<input type="checkbox"/>	<input type="checkbox"/>	<input type="checkbox"/>
	<input type="checkbox"/>	<input type="checkbox"/>	<input type="checkbox"/>	<input type="checkbox"/>
	<input type="checkbox"/>	<input type="checkbox"/>	<input type="checkbox"/>	<input type="checkbox"/>
	<input type="checkbox"/>	<input type="checkbox"/>	<input type="checkbox"/>	<input type="checkbox"/>
	<input type="checkbox"/>	<input type="checkbox"/>	<input type="checkbox"/>	<input type="checkbox"/>
	<input type="checkbox"/>	<input type="checkbox"/>	<input type="checkbox"/>	<input type="checkbox"/>
	<input type="checkbox"/>	<input type="checkbox"/>	<input type="checkbox"/>	<input type="checkbox"/>
	<input type="checkbox"/>	<input type="checkbox"/>	<input type="checkbox"/>	<input type="checkbox"/>
	<input type="checkbox"/>	<input type="checkbox"/>	<input type="checkbox"/>	<input type="checkbox"/>
	<input type="checkbox"/>	<input type="checkbox"/>	<input type="checkbox"/>	<input type="checkbox"/>
	<input type="checkbox"/>	<input type="checkbox"/>	<input type="checkbox"/>	<input type="checkbox"/>
	<input type="checkbox"/>	<input type="checkbox"/>	<input type="checkbox"/>	<input type="checkbox"/>
	<input type="checkbox"/>	<input type="checkbox"/>	<input type="checkbox"/>	<input type="checkbox"/>
	<input type="checkbox"/>	<input type="checkbox"/>	<input type="checkbox"/>	<input type="checkbox"/>
	<input type="checkbox"/>	<input type="checkbox"/>	<input type="checkbox"/>	<input type="checkbox"/>
	<input type="checkbox"/>	<input type="checkbox"/>	<input type="checkbox"/>	<input type="checkbox"/>
	<input type="checkbox"/>	<input type="checkbox"/>	<input type="checkbox"/>	<input type="checkbox"/>
	<input type="checkbox"/>	<input type="checkbox"/>	<input type="checkbox"/>	<input type="checkbox"/>
	<input type="checkbox"/>	<input type="checkbox"/>	<input type="checkbox"/>	<input type="checkbox"/>
	<input type="checkbox"/>	<input type="checkbox"/>	<input type="checkbox"/>	<input type="checkbox"/>
	<input type="checkbox"/>	<input type="checkbox"/>	<input type="checkbox"/>	<input type="checkbox"/>
	<input type="checkbox"/>	<input type="checkbox"/>	<input type="checkbox"/>	<input type="checkbox"/>
	<input type="checkbox"/>	<input type="checkbox"/>	<input type="checkbox"/>	<input type="checkbox"/>
	<input type="checkbox"/>	<input type="checkbox"/>	<input type="checkbox"/>	<input type="checkbox"/>
	<input type="checkbox"/>	<input type="checkbox"/>	<input type="checkbox"/>	<input type="checkbox"/>
	<input type="checkbox"/>	<input type="checkbox"/>	<input type="checkbox"/>	<input type="checkbox"/>
	<input type="checkbox"/>	<input type="checkbox"/>	<input type="checkbox"/>	<input type="checkbox"/>
	<input type="checkbox"/>	<input type="checkbox"/>	<input type="checkbox"/>	<input type="checkbox"/>
	<input type="checkbox"/>	<input type="checkbox"/>	<input type="checkbox"/>	<input type="checkbox"/>
	<input type="checkbox"/>	<input type="checkbox"/>	<input type="checkbox"/>	<input type="checkbox"/>
	<input type="checkbox"/>	<input type="checkbox"/>	<input type="checkbox"/>	<input type="checkbox"/>
	<input type="checkbox"/>	<input type="checkbox"/>	<input type="checkbox"/>	<input type="checkbox"/>
	<input type="checkbox"/>	<input type="checkbox"/>	<input type="checkbox"/>	<input type="checkbox"/>
	<input type="checkbox"/>	<input type="checkbox"/>	<input type="checkbox"/>	<input type="checkbox"/>
	<input type="checkbox"/>	<input type="checkbox"/>	<input type="checkbox"/>	<input type="checkbox"/>
	<input type="checkbox"/>	<input type="checkbox"/>	<input type="checkbox"/>	<input type="checkbox"/>
	<input type="checkbox"/>	<input type="checkbox"/>	<input type="checkbox"/>	<input type="checkbox"/>
	<input type="checkbox"/>	<input type="checkbox"/>	<input type="checkbox"/>	<input type="checkbox"/>
	<input type="checkbox"/>	<input type="checkbox"/>	<input type="checkbox"/>	<input type="checkbox"/>
	<input type="checkbox"/>	<input type="checkbox"/>	<input type="checkbox"/>	<input type="checkbox"/>
	<input type="checkbox"/>	<input type="checkbox"/>	<input type="checkbox"/>	<input type="checkbox"/>
	<input type="checkbox"/>	<input type="checkbox"/>	<input type="checkbox"/>	<input type="checkbox"/>
	<input type="checkbox"/>	<input type="checkbox"/>	<input type="checkbox"/>	<input type="checkbox"/>
	<input type="checkbox"/>	<input type="checkbox"/>	<input type="checkbox"/>	<input type="checkbox"/>
	<input type="checkbox"/>	<input type="checkbox"/>	<input type="checkbox"/>	<input type="checkbox"/>
	<input type="checkbox"/>	<input type="checkbox"/>	<input type="checkbox"/>	<input type="checkbox"/>
	<input type="checkbox"/>	<input type="checkbox"/>	<input type="checkbox"/>	<input type="checkbox"/>
	<input type="checkbox"/>	<input type="checkbox"/>	<input type="checkbox"/>	<input type="checkbox"/>
	<input type="checkbox"/>	<input type="checkbox"/>	<input type="checkbox"/>	<input type="checkbox"/>
	<input type="checkbox"/>	<input type="checkbox"/>	<input type="checkbox"/>	<input type="checkbox"/>
	<input type="checkbox"/>	<input type="checkbox"/>	<input type="checkbox"/>	<input type="checkbox"/>
	<input type="checkbox"/>	<input type="checkbox"/>	<input type="checkbox"/>	<input type="checkbox"/>
	<input type="checkbox"/>	<input type="checkbox"/>	<input type="checkbox"/>	<input type="checkbox"/>
	<input type="checkbox"/>	<input type="checkbox"/>	<input type="checkbox"/>	<input type="checkbox"/>
	<input type="checkbox"/>	<input type="checkbox"/>	<input type="checkbox"/>	<input type="checkbox"/>
	<input type="checkbox"/>	<input type="checkbox"/>	<input type="checkbox"/>	<input type="checkbox"/>
	<input type="checkbox"/>	<input type="checkbox"/>	<input type="checkbox"/>	<input type="checkbox"/>
	<input type="checkbox"/>	<input type="checkbox"/>	<input type="checkbox"/>	<input type="checkbox"/>
	<input type="checkbox"/>	<input type="checkbox"/>	<input type="checkbox"/>	<input type="checkbox"/>
	<input type="checkbox"/>	<input type="checkbox"/>	<input type="checkbox"/>	<input type="checkbox"/>
	<input type="checkbox"/>	<input type="checkbox"/>	<input type="checkbox"/>	<input type="checkbox"/>
	<input type="checkbox"/>	<input type="checkbox"/>	<input type="checkbox"/>	<input type="checkbox"/>
	<input type="checkbox"/>	<input type="checkbox"/>	<input type="checkbox"/>	<input type="checkbox"/>
	<input type="checkbox"/>	<input type="checkbox"/>	<input type="checkbox"/>	<input type="checkbox"/>
	<input type="checkbox"/>	<input type="checkbox"/>	<input type="checkbox"/>	<input type="checkbox"/>
	<input type="checkbox"/>	<input type="checkbox"/>	<input type="checkbox"/>	<input type="checkbox"/>
	<input type="checkbox"/>	<input type="checkbox"/>	<input type="checkbox"/>	<input type="checkbox"/>
	<input type="checkbox"/>	<input type="checkbox"/>	<input type="checkbox"/>	<input type="checkbox"/>
	<input type="checkbox"/>	<input type="checkbox"/>	<input type="checkbox"/>	<input type="checkbox"/>
	<input type="checkbox"/>	<input type="checkbox"/>	<input type="checkbox"/>	<input type="checkbox"/>
	<input type="checkbox"/>	<input type="checkbox"/>	<input type="checkbox"/>	<input type="checkbox"/>
	<input type="checkbox"/>	<input type="checkbox"/>	<input type="checkbox"/>	<input type="checkbox"/>
	<input type="checkbox"/>	<input type="checkbox"/>	<input type="checkbox"/>	<input type="checkbox"/>
	<input type="checkbox"/>	<input type="checkbox"/>	<input type="checkbox"/>	<input type="checkbox"/>
	<input type="checkbox"/>	<input type="checkbox"/>	<input type="checkbox"/>	<input type="checkbox"/>
	<input type="checkbox"/>	<input type="checkbox"/>	<input type="checkbox"/>	<input type="checkbox"/>
	<input type="checkbox"/>	<input type="checkbox"/>	<input type="checkbox"/>	<input type="checkbox"/>
	<input type="checkbox"/>	<input type="checkbox"/>	<input type="checkbox"/>	<input type="checkbox"/>
	<input type="checkbox"/>	<input type="checkbox"/>	<input type="checkbox"/>	<input type="checkbox"/>
	<input type="checkbox"/>	<input type="checkbox"/>	<input type="checkbox"/>	<input type="checkbox"/>
	<input type="checkbox"/>	<input type="checkbox"/>	<input type="checkbox"/>	<input type="checkbox"/>
	<input type="checkbox"/>	<input type="checkbox"/>	<input type="checkbox"/>	<input type="checkbox"/>
	<input type="checkbox"/>	<input type="checkbox"/>	<input type="checkbox"/>	<input type="checkbox"/>
	<input type="checkbox"/>	<input type="checkbox"/>	<input type="checkbox"/>	<input type="checkbox"/>
	<input type="checkbox"/>	<input type="checkbox"/>	<input type="checkbox"/>	<input type="checkbox"/>
	<input type="checkbox"/>	<input type="checkbox"/>	<input type="checkbox"/>	<input type="checkbox"/>
	<input type="checkbox"/>	<input type="checkbox"/>	<input type="checkbox"/>	<input type="checkbox"/>
	<input type="checkbox"/>	<input type="checkbox"/>	<input type="checkbox"/>	<input type="checkbox"/>
	<input type="checkbox"/>	<input type="checkbox"/>	<input type="checkbox"/>	<input type="checkbox"/>
	<input type="checkbox"/>	<input type="checkbox"/>	<input type="checkbox"/>	<input type="checkbox"/>
	<input type="checkbox"/>	<input type="checkbox"/>	<input type="checkbox"/>	<input type="checkbox"/>
	<input type="checkbox"/>	<input type="checkbox"/>	<input type="checkbox"/>	<input type="checkbox"/>
	<input type="checkbox"/>	<input type="checkbox"/>	<input type="checkbox"/>	<input type="checkbox"/>
	<input type="checkbox"/>	<input type="checkbox"/>	<input type="checkbox"/>	<input type="checkbox"/>
	<input type="checkbox"/>	<input type="checkbox"/>	<input type="checkbox"/>	<input type="checkbox"/>
	<input type="checkbox"/>	<input type="checkbox"/>	<input type="checkbox"/>	<input type="checkbox"/>
	<input type="checkbox"/>	<input type="checkbox"/>	<input type="checkbox"/>	<input type="checkbox"/>
	<input type="checkbox"/>	<input type="checkbox"/>	<input type="checkbox"/>	<input type="checkbox"/>
	<input type="checkbox"/>	<input type="checkbox"/>	<input type="checkbox"/>	<input type="checkbox"/>
	<input type="checkbox"/>	<input type="checkbox"/>	<input type="checkbox"/>	<input type="checkbox"/>
	<input type="checkbox"/>	<input type="checkbox"/>	<input type="checkbox"/>	<input type="checkbox"/>
	<input type="checkbox"/>	<input type="checkbox"/>	<input type="checkbox"/>	<input type="checkbox"/>
	<input type="checkbox"/>	<input type="checkbox"/>	<input type="checkbox"/>	<input type="checkbox"/>
	<input type="checkbox"/>	<input type="checkbox"/>	<input type="checkbox"/>	<input type="checkbox"/>
	<input type="checkbox"/>	<input type="checkbox"/>	<input type="checkbox"/>	<input type="checkbox"/>
	<input type="checkbox"/>	<input type="checkbox"/>	<input type="checkbox"/>	<input type="checkbox"/>
	<input type="checkbox"/>	<input type="checkbox"/>	<input type="checkbox"/>	<input type="checkbox"/>
	<input type="checkbox"/>	<input type="checkbox"/>	<input type="checkbox"/>	<input type="checkbox"/>
	<input type="checkbox"/>	<input type="checkbox"/>	<input type="checkbox"/>	<input type="checkbox"/>
	<input type="checkbox"/>	<input type="checkbox"/>	<input type="checkbox"/>	<input type="checkbox"/>
	<input type="checkbox"/>	<input type="checkbox"/>	<input type="checkbox"/>	<input type="checkbox"/>
	<input type="checkbox"/>	<input type="checkbox"/>	<input type="checkbox"/>	<input type="checkbox"/>
	<input type="checkbox"/>	<input type="checkbox"/>	<input type="checkbox"/>	<input type="checkbox"/>
	<input type="checkbox"/>	<input type="checkbox"/>	<input type="checkbox"/>	<input type="checkbox"/>
	<input type="checkbox"/>	<input type="checkbox"/>	<input type="checkbox"/>	<input type="checkbox"/>
	<input type="checkbox"/>	<input type="checkbox"/>	<input type="checkbox"/>	<input type="checkbox"/>
	<input type="checkbox"/>	<input type="checkbox"/>	<input type="checkbox"/>	<input type="checkbox"/>
	<input type="checkbox"/>	<input type="checkbox"/>	<input type="checkbox"/>	<input type="checkbox"/>
	<input type="checkbox"/>	<input type="checkbox"/>	<input type="checkbox"/>	<input type="checkbox"/>
	<input type="checkbox"/>	<input type="checkbox"/>	<input type="checkbox"/>	<input type="checkbox"/>
	<input type="checkbox"/>	<input type="checkbox"/>	<input type="checkbox"/>	<input type="checkbox"/>
	<input type="checkbox"/>	<input type="checkbox"/>	<input type="checkbox"/>	<input type="checkbox"/>
	<input type="checkbox"/>	<input type="checkbox"/>	<input type="checkbox"/>	<input type="checkbox"/>
	<input type="checkbox"/>	<input type="checkbox"/>	<input type="checkbox"/>	<input type="checkbox"/>
	<input type="checkbox"/>	<input type="checkbox"/>	<input type="checkbox"/>	<input type="checkbox"/>
	<input type="checkbox"/>	<input type="checkbox"/>	<input type="checkbox"/>	<input type="checkbox"/>
	<input type="checkbox"/>	<input type="checkbox"/>	<input type="checkbox"/>	<input type="checkbox"/>
	<input type="checkbox"/>	<input type="checkbox"/>	<input type="checkbox"/>	<input type="checkbox"/>
	<input type="checkbox"/>	<input type="checkbox"/>	<input type="checkbox"/>	<input type="checkbox"/>
	<input type="checkbox"/>	<input type="checkbox"/>	<input type="checkbox"/>	<input type="checkbox"/>
	<input type="checkbox"/>	<input type="checkbox"/>	<input type="checkbox"/>	<input type="checkbox"/>
	<input type="checkbox"/>	<input type="checkbox"/>	<input type="checkbox"/>	<input type="checkbox"/>
	<input type="checkbox"/>	<input type="checkbox"/>	<input type="checkbox"/>	<input type="checkbox"/>
	<input type="checkbox"/>	<input type="checkbox"/>	<input type="checkbox"/>	<input type="checkbox"/>
	<input type="checkbox"/>	<input type="checkbox"/>	<input type="checkbox"/>	<input type="checkbox"/>
	<input type="checkbox"/>	<input type="checkbox"/>	<input type="checkbox"/>	<input type="checkbox"/>
	<input type="checkbox"/>	<input type="checkbox"/>	<input type="checkbox"/>	<input type="checkbox"/>
	<input type="checkbox"/>	<input type="checkbox"/>	<input type="checkbox"/>	<input type="checkbox"/>
	<input type="checkbox"/>	<input type="checkbox"/>	<input type="checkbox"/>	<input type="checkbox"/>
	<input type="checkbox"/>	<input type="checkbox"/>	<input type="checkbox"/>	<input type="checkbox"/>
	<input type="checkbox"/>	<input type="checkbox"/>	<input type="checkbox"/>	<input type="checkbox"/>

# MALTA

SERIE





**MALTA**  
**PVD COLLECTION**

SERIE







# MALTA

## CROMO

SERIE



Instalación >



Ref.: GCE006

Grifería monomando extraíble.  
Cuerpo de grifería cromado.  
Cartucho cerámico de Ø35 mm.  
Latiguillos 50cm.

Cod.: 000115.00

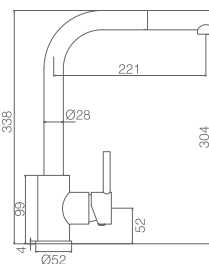

Grifería con certificación





# MALTA

## ACERO INOX. S.316

SERIE



Ref.: GCE006/AC

Grifería monomando extraíble.  
Cuerpo de grifería en **acero inox. S.316**.  
Cartucho cerámico de Ø35mm.  
Latiguillos 50cm.

Cod.: 000154.00

Grifería con  
certificación

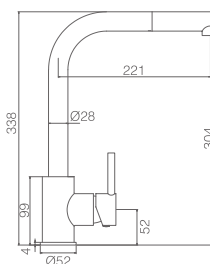





# MALTA

## BLACK GUN METAL

SERIE

# PVD

## COLLECTION



Instalación >



Ref.: **GCE006/BGM**

Grifería monomando extraíble.  
Cuerpo de grifería black gun metal.  
Cartucho cerámico de Ø35 mm.  
Latiguillos 50cm.

Cod.: 000145.00

Grifería con  
certificación

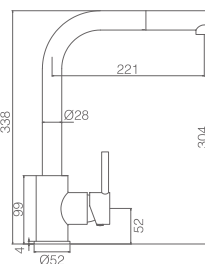

# MALTA NEGRO MATE

SERIE

SISTEMA LACADO  
ELECTROFORESIS

Ref.: GCE006/NG

Grifería monomando extraíble.  
Cuerpo de grifería negro mate.  
Cartucho cerámico de Ø35 mm.  
Latiguillos 50cm.

Cod.: 000135.00

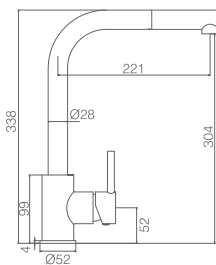

Grifería con  
certificación









# MALTA BLANCO MATE

SERIE

Instalación >



Ref.: **GCE006/BL**

Grifería monomando extraíble.  
Cuerpo de grifería blanco mate.  
Cartucho cerámico de Ø35 mm.  
Latiguillos 50cm.

Cod.: 000130.00

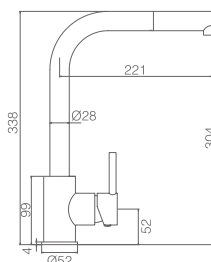

Grifería con  
certificación





# MALTA

## ORO CEPILLADO

SERIE



## PVD

### COLLECTION

Ref.: GCE006/OC

Grifería monomando extraíble.  
Cuerpo de grifería oro cepillado.  
Cartucho cerámico de Ø35 mm.  
Latiguillos 50cm.

Cod.: 000145.00

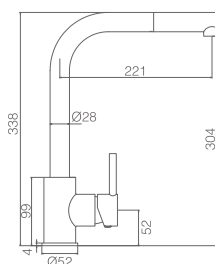

Grifería con  
certificación







# MALTA

## ORO ROSA CEPILLADO

SERIE

# PVD

## COLLECTION



Ref.: **GCE006/ORC**

Grifería monomando extraíble.  
Cuerpo de grifería oro rosa cepillado.  
Cartucho cerámico de  $\varnothing 35$  mm.  
Latiguillos 50cm.

Cod.: 000148.00

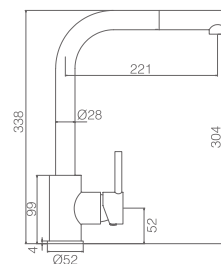

Grifería con  
certificación



**SENA**  
**PVD COLLECTION**

SERIE





# SENA CROMO

SERIE

Ref.: GCE022

Grifería monomando flexible.  
Cuerpo de grifería cromado.  
Cartucho cerámico de Ø30 mm.  
Latiguillos 50cm.

Cod.: 000128.00

Grifería con  
certificación

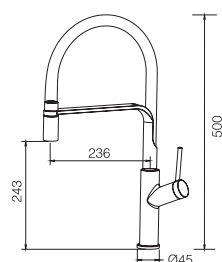





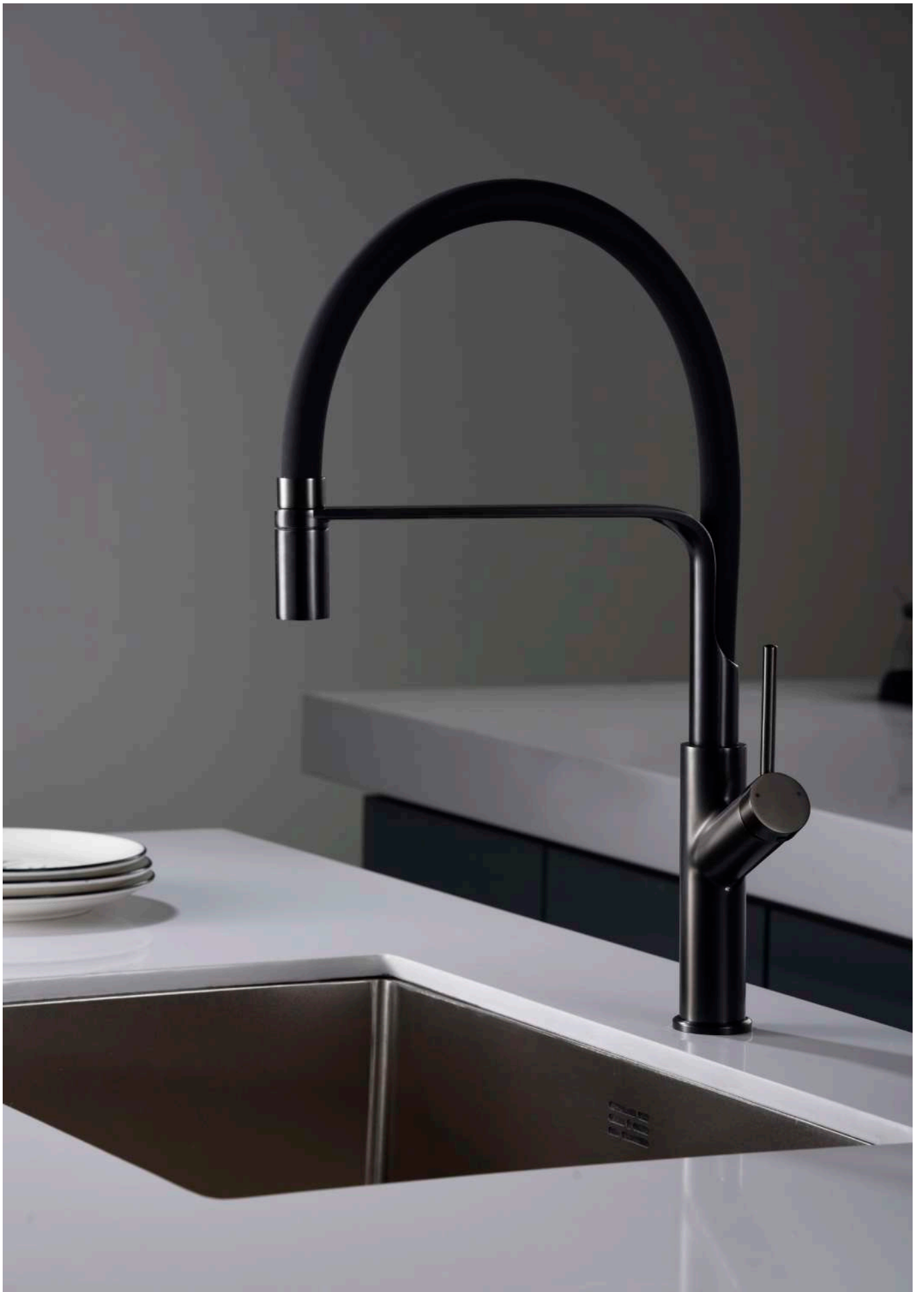

# SENA

## BLACK GUN METAL

SERIE

# PVD

## COLLECTION



Ref.: **GCE022/BGM**

Grifería monomando flexible.  
Cuerpo de grifería black gun metal.  
Cartucho cerámico de Ø30 mm.  
Latiguillos 50cm.

Cod.: 000151.00

Grifería con  
certificación

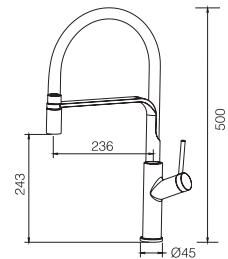

# SENA NEGRO MATE

SERIE

SISTEMA LACADO  
ELECTROFORESIS

Ref.: GCE022/NG

Grifería monomando flexible.  
Cuerpo de grifería negro mate.  
Cartucho cerámico de Ø30 mm.  
Latiguillos 50cm.

Cod.: 000135.00

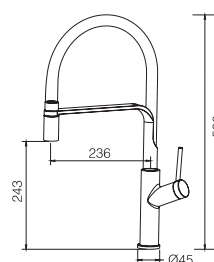

Grifería con  
certificación







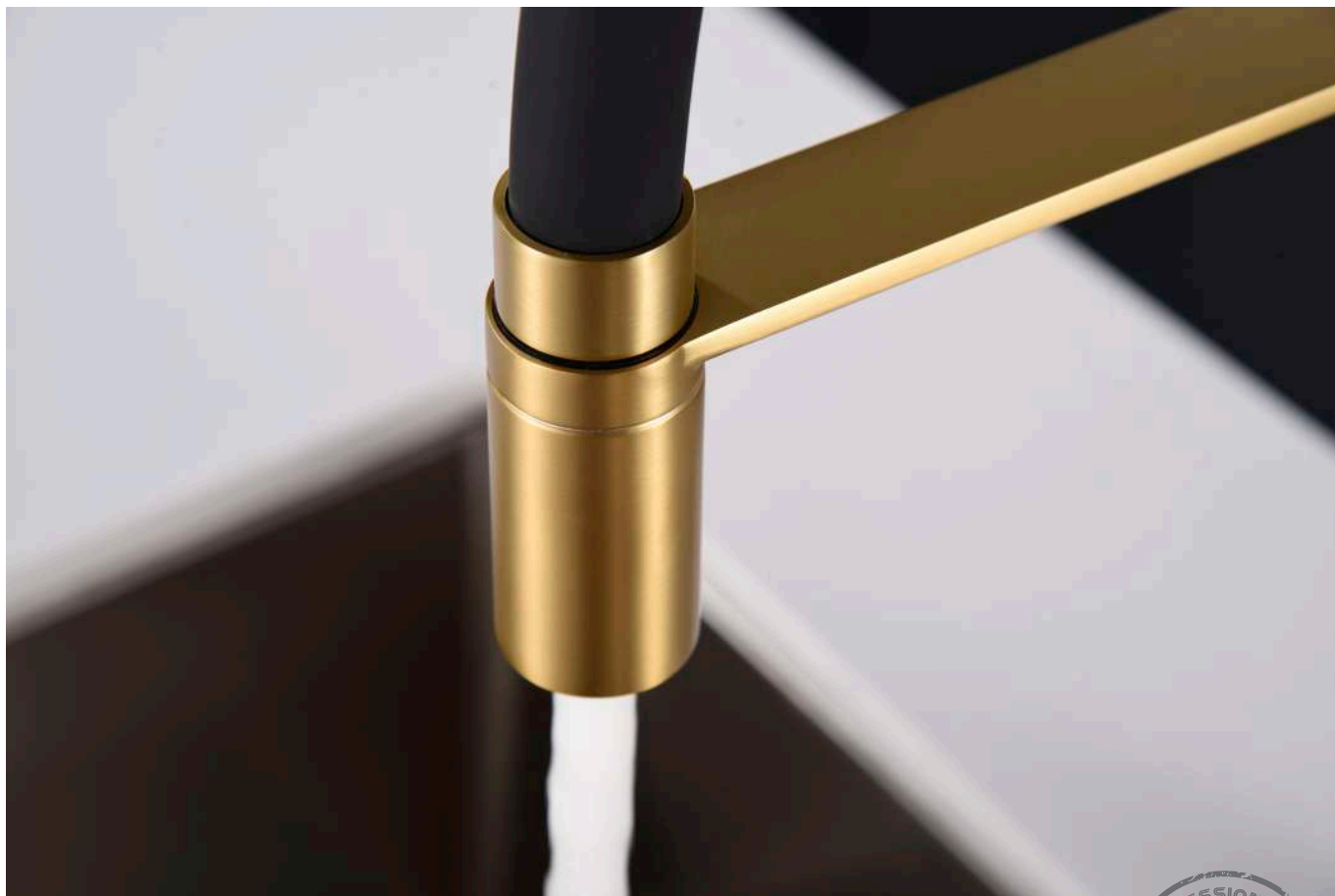

# SENA

## ORO CEPILLADO

SERIE



# PVD

## COLLECTION

Ref.: GCE022/OC

Grifería monomando flexible.  
Cuerpo de grifería oro cepillado.  
Cartucho cerámico de Ø30 mm.  
Latiguillos 50cm.

Cod.: 000148.00

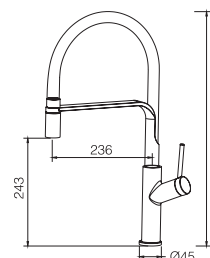

Grifería con certificación



# SENA

## ORO ROSA CEPILLADO

SERIE

## PVD COLLECTION



Ref.: GCE022/ORC

Grifería monomando flexible.  
Cuerpo de grifería cromado.  
Cartucho cerámico de Ø30 mm.  
Latiguillos 50cm.

Cod.: 000148.00

Grifería con  
certificación

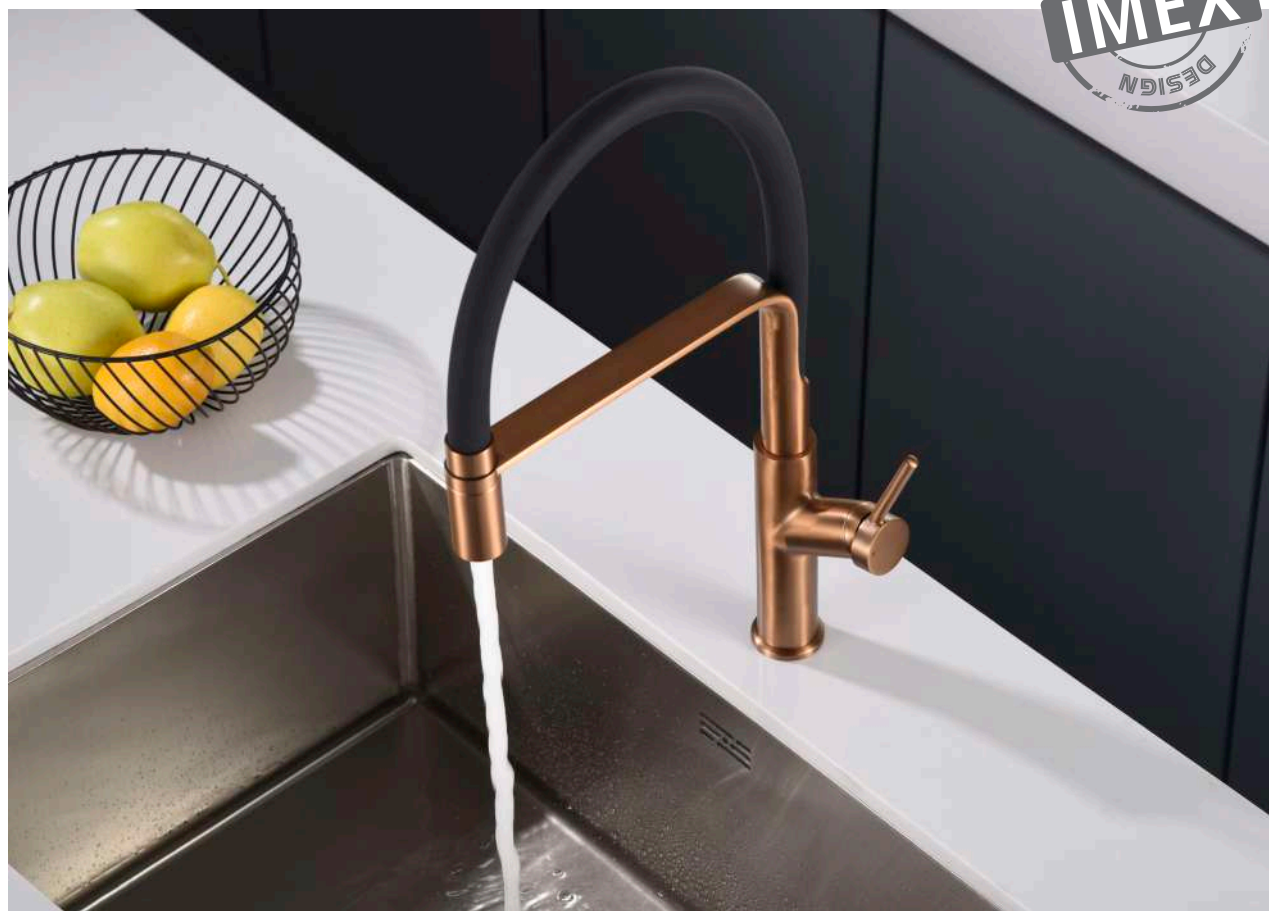
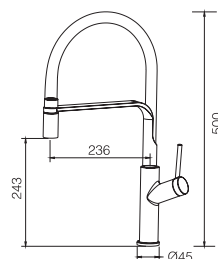





**BERNA**  
**PVD COLLECTION**  
SERIE







# BERNA CROMO

SERIE

Ref.: GCE026

Grifería monomando extraíble.  
Cuerpo de grifería cromado.  
Difusor con dos funciones.  
Cartucho cerámico de Ø35 mm.  
Latiguillos 50cm.

Apertura en frío.

Cod.: 000136.00



SISTEMA DE  
AHORRO  
ENERGÉTICO

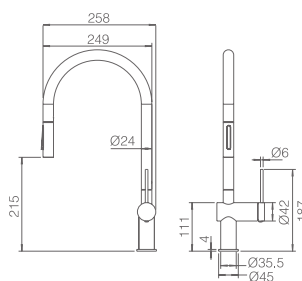

Grifería con  
certificación





# BERNA NEGRO MATE

SERIE

SISTEMA LACADO  
ELECTROFORESIS

Ref.: GCE026/NG

Grifería monomando extraíble.  
Cuerpo de grifería negro mate.  
Difusor con dos funciones.  
Cartucho cerámico de Ø35 mm.  
Latiguillos 50cm.

Apertura en frío.

Cod.: 000143.00



SISTEMA DE  
AHORRO  
ENERGÉTICO

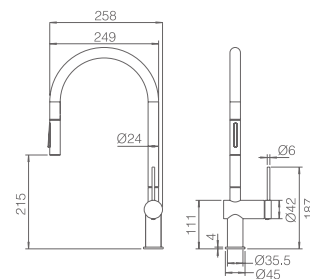



# BERNA

## ORO CEPILLADO

SERIE

# PVD

## COLLECTION



SISTEMA DE AHORRO ENERGÉTICO

Ref.: GCE026/OC

Grifería monomando extraíble.  
Cuerpo de grifería oro cepillado.  
Difusor con dos funciones.  
Cartucho cerámico de Ø35 mm.  
Latiguillos 50cm.

Apertura en frío.

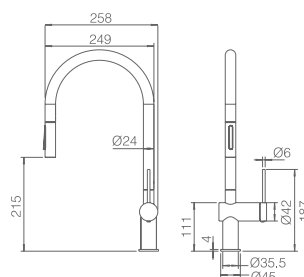

Cod.: 000149.00

Grifería con certificación







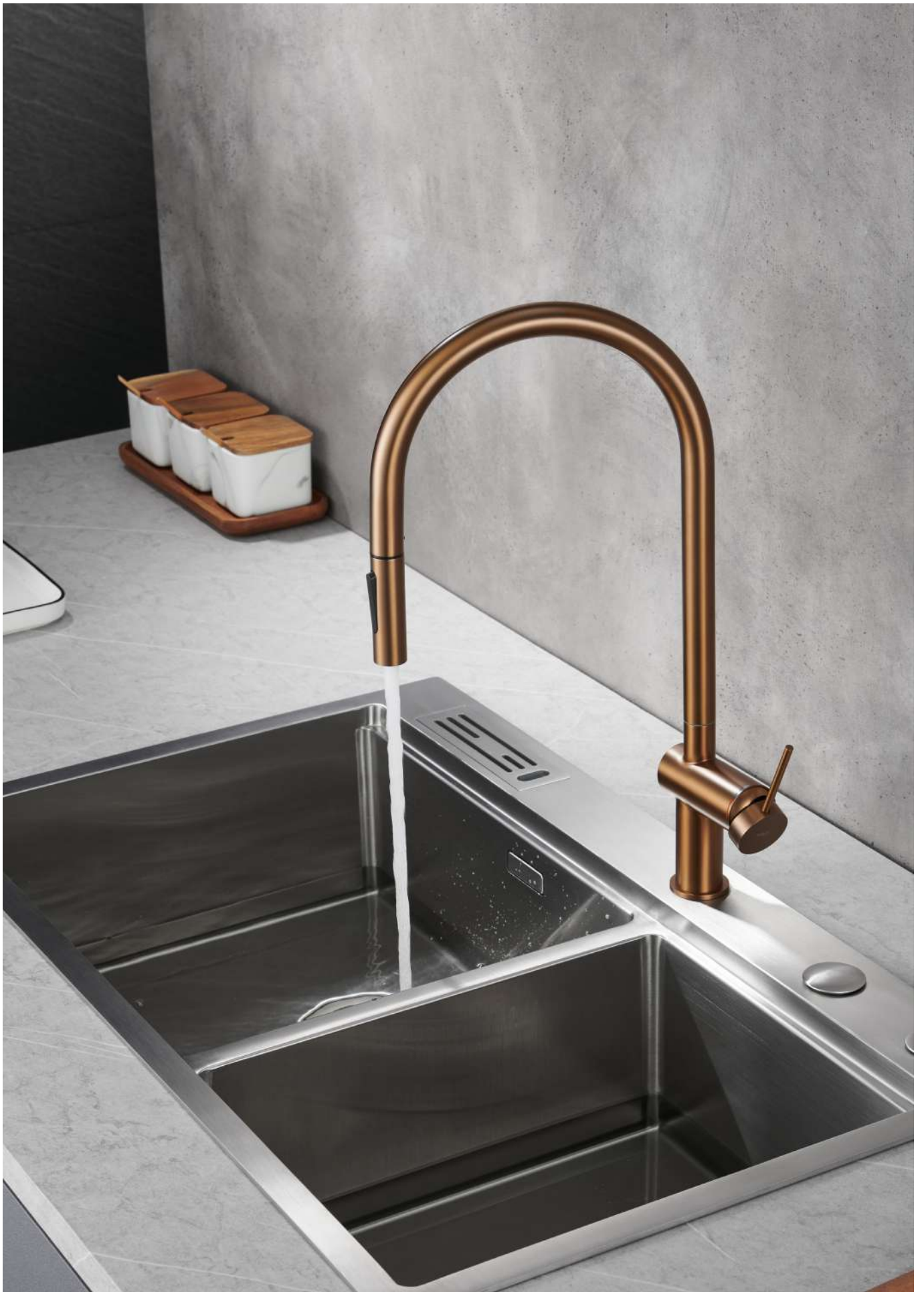

# BERNA

## ORO ROSA CEPILLADO

SERIE

# PVD

## COLLECTION



SISTEMA DE AHORRO ENERGÉTICO

### Ref.: GCE026/ORC

Grifería monomando extraíble.  
Cuerpo de grifería oro rosa cepillado.  
Difusor con dos funciones.  
Cartucho cerámico de Ø35 mm.  
Latiguillos 50cm.

Apertura en frío.

Cod.: 000154.00

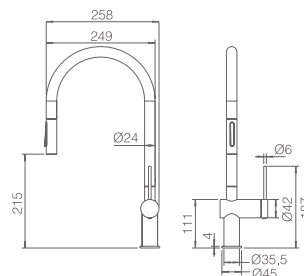

Grifería con certificación



**NIZA**  
**PVD COLLECTION**  
SERIE









# NIZA CROMO

SERIE

Ref.: **GCE027**

Grifería monomando extraíble.  
Cuerpo de grifería cromado.  
Difusor con dos funciones.  
Cartucho cerámico de Ø30 mm.  
Latiguillos 50cm.

Cod.: 000141.00

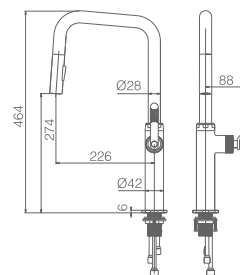

Grifería con  
certificación



# NIZA

## BLACK GUN METAL

SERIE

# PVD

## COLLECTION

Ref.: GCE027/BGM

Grifería monomando extraíble.  
Cuerpo de grifería black gun metal.  
Difusor con dos funciones.  
Cartucho cerámico de Ø30 mm.  
Latiguillos 50cm.

Cod.: 000162.00

Grifería con  
certificación

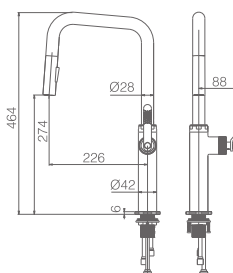







# NIZA NEGRO MATE

SERIE

SISTEMA LACADO  
ELECTROFORESIS

Ref.: GCE027/NG

Grifería monomando extraíble.  
Cuerpo de grifería negro mate.  
Difusor con dos funciones.  
Cartucho cerámico de Ø30 mm.  
Latiguillos 50cm.

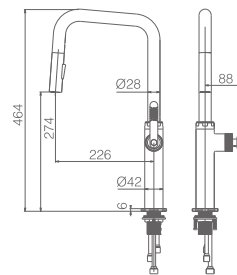

Cod.: 000149.00

Grifería con  
certificación





# NIZA

## ORO CEPILLADO

SERIE

# PVD

## COLLECTION

Ref.: GCE027/OC

Grifería monomando extraíble.  
Cuerpo de grifería cromado.  
Difusor con dos funciones.  
Cartucho cerámico de Ø30 mm.  
Latiguillos 50cm.

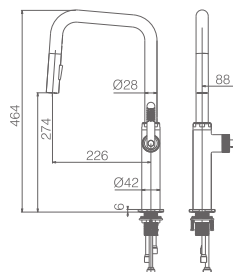

Cod.: 000159.00

Grifería con  
certificación







# NIZA

## ORO ROSA CEPILLADO

SERIE



## PVD COLLECTION



Ref.: GCE027/ORC

Grifería monomando extraíble.  
Cuerpo de grifería cromado.  
Difusor con dos funciones.  
Cartucho cerámico de Ø30 mm.  
Latiguillos 50cm.

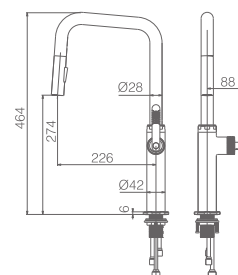

Cod.: 000162.00

Grifería con  
certificación



**LOIRA**  
**PVD COLLECTION**  
SERIE









# LOIRA CROMO

SERIE



Opcional, ver página 165 del catálogo

Ref.: GCR004

Grifería monomando.  
Cuerpo de grifería cromado.  
Cartucho cerámico de Ø35 mm.  
Latiguillos 50cm.  
Aireador rótula no incluido.

Cod.: 000064.00

Grifería con  
certificación

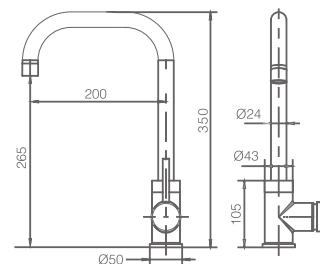

# LOIRA

## BLACK GUN METAL

SERIE

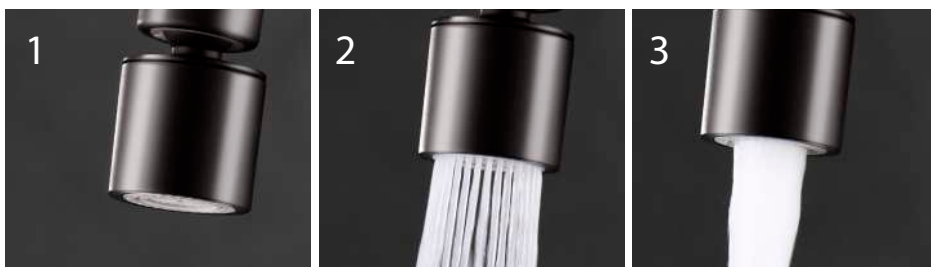

Opcional, ver página 165 del catálogo



# PVD

## COLLECTION



Ref.: GCR004/BGM

Grifería monomando.  
Cuerpo de grifería black gun metal.  
Cartucho cerámico de Ø35 mm.  
Latiguillos 50cm.  
Aireador rótula no incluido.

Cod.: 000082.00

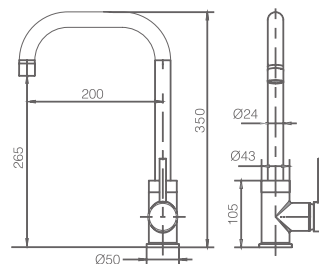

Grifería con  
certificación









# LOIRA NEGRO MATE

SERIE



Opcional, ver página 165 del catálogo

SISTEMA LACADO  
ELECTROFORESIS

Ref.: **GCR004/NG**

Grifería monomando.  
Cuerpo de grifería negro mate.  
Cartucho cerámico de Ø35 mm.  
Latiguillos 50cm.  
Aireador rótula no incluido.

Cod.: 000068.00

Grifería con  
certificación

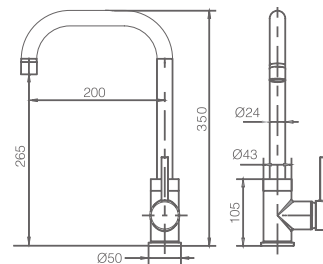

# LOIRA ORO CEPILLADO

SERIE

## PVD COLLECTION

Ref.: GCR004/OC

Grifería monomando.  
Cuerpo de grifería oro cepillado.  
Cartucho cerámico de Ø35 mm.  
Latiguillos 50cm.  
Aireador rótula no incluido.

Cod.: 000081.00

Grifería con  
certificación



Opcional, ver página 165 del catálogo

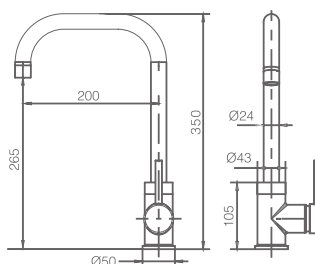







# LOIRA

## ORO ROSA CEPILLADO

SERIE



Opcional, ver página 165 del catálogo



# PVD

## COLLECTION



Ref.: GCR004/ORC

Grifería monomando.  
Cuerpo de grifería oro rosa cepillado.  
Cartucho cerámico de Ø35 mm.  
Latiguillos 50cm.  
Aireador rótula no incluido.

Cod.: 000082.00

Grifería con  
certificación

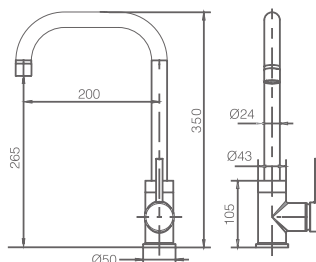

**TURÍN**

SERIE



PROFESSIONAL  
**IMEX**  
DESIGN





# TURÍN CROMO

SERIE



Instrucciones de instalación  
y mantenimiento.

Ref.: GCE021

Grifería monomando extraíble.  
Tecnología on/off (start/stop) con sensor de movimiento  
y panel digital con temperatura de agua.  
Cuerpo de grifería cromado.  
Difusor con dos funciones.  
Cartucho cerámico de Ø35 mm.  
Latiguillos 50cm.

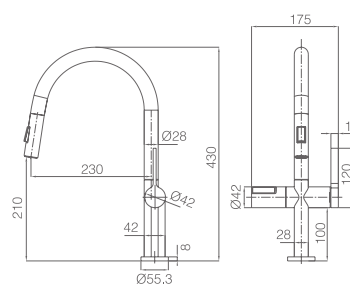

Cod.: 000226.00

Grifería con  
certificación







# TURÍN NEGRO MATE

SERIE

SISTEMA LACADO  
ELECTROFORESIS

Ref.: GCE021/NG

Grifería monomando extraíble.  
Tecnología on/off (start/stop) con sensor de movimiento y panel digital con temperatura de agua.  
Cuerpo de grifería negro mate.  
Difusor con dos funciones.  
Cartucho cerámico de Ø35 mm.  
Latiguillos 50cm.

Cod.: 000236.00

Grifería con  
certificación



Instrucciones de instalación  
y mantenimiento.

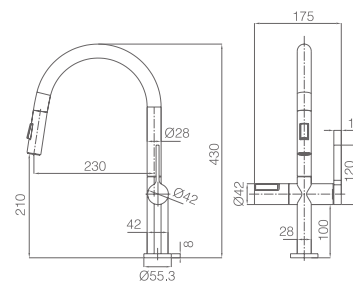



# BÉLGICA

SERIE





PROFESSIONAL  
**IMEX**  
DESIGN





# BÉLGICA

## CROMO

SERIE



Opcional, ver página 165 del catálogo

**Ref.: GCZ044**

Grifería monomando.  
Cuerpo de grifería cromado.  
Cartucho cerámico de Ø35 mm.  
Latiguillos 50cm.  
Aireador rótula no incluido.

**Cod.: 000060.00**

Grifería con  
certificación

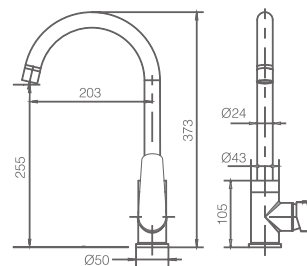

# BÉLGICA NEGRO MATE

SERIE

SISTEMA LACADO  
ELECTROFORESIS



Opcional, ver página 165 del catálogo

Ref.: GCZ044/NG

Grifería monomando.  
Cuerpo de grifería negro mate.  
Cartucho cerámico de Ø35 mm.  
Latiguillos 50cm.  
Aireador rótula no incluido.

Cod.: 000068.00

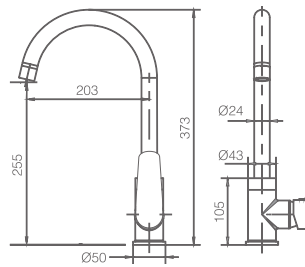

Grifería con  
certificación







**BONN**  
**PVD COLLECTION**  
SERIE







# BONN CROMO

SERIE

Ref.: GCE024

Grifería monomando extraíble.  
Cuerpo de grifería cromado.  
Difusor con dos funciones.  
Cartucho cerámico de Ø35 mm.  
Latiguillos 50cm.

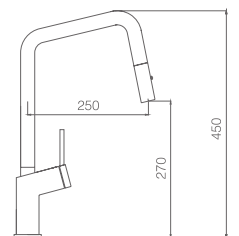

Cod.: 000134.00

Grifería con  
certificación



# BONN

## BLACK GUN METAL

SERIE



## PVD

### COLLECTION

Ref.: GCE024/BGM

Grifería monomando extraíble.  
Cuerpo de grifería black gun metal.  
Difusor con dos funciones.  
Cartucho cerámico de Ø35 mm.  
Latiguillos 50cm.

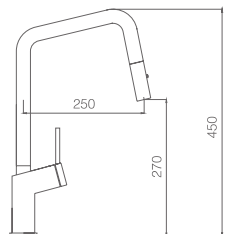

Cod.: 000159.00

Grifería con  
certificación









# BONN NEGRO MATE

SERIE

SISTEMA LACADO  
ELECTROFORESIS

Ref.: **GCE024/NG**

Grifería monomando extraíble.  
Cuerpo de grifería negro mate.  
Difusor con dos funciones.  
Cartucho cerámico de Ø35 mm.  
Latiguillos 50cm.

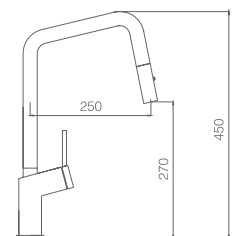

Cod.: 000142.00

Grifería con  
certificación





# BONN

## ORO CEPILLADO

SERIE

# PVD

## COLLECTION

Ref.: GCE024/OC

Grifería monomando extraíble.  
Cuerpo de grifería oro cepillado.  
Difusor con dos funciones.  
Cartucho cerámico de Ø35 mm.  
Latiguillos 50cm.

Cod.: 000157.00

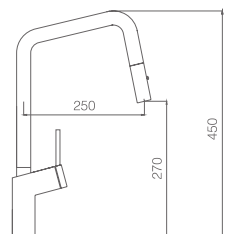

Grifería con  
certificación







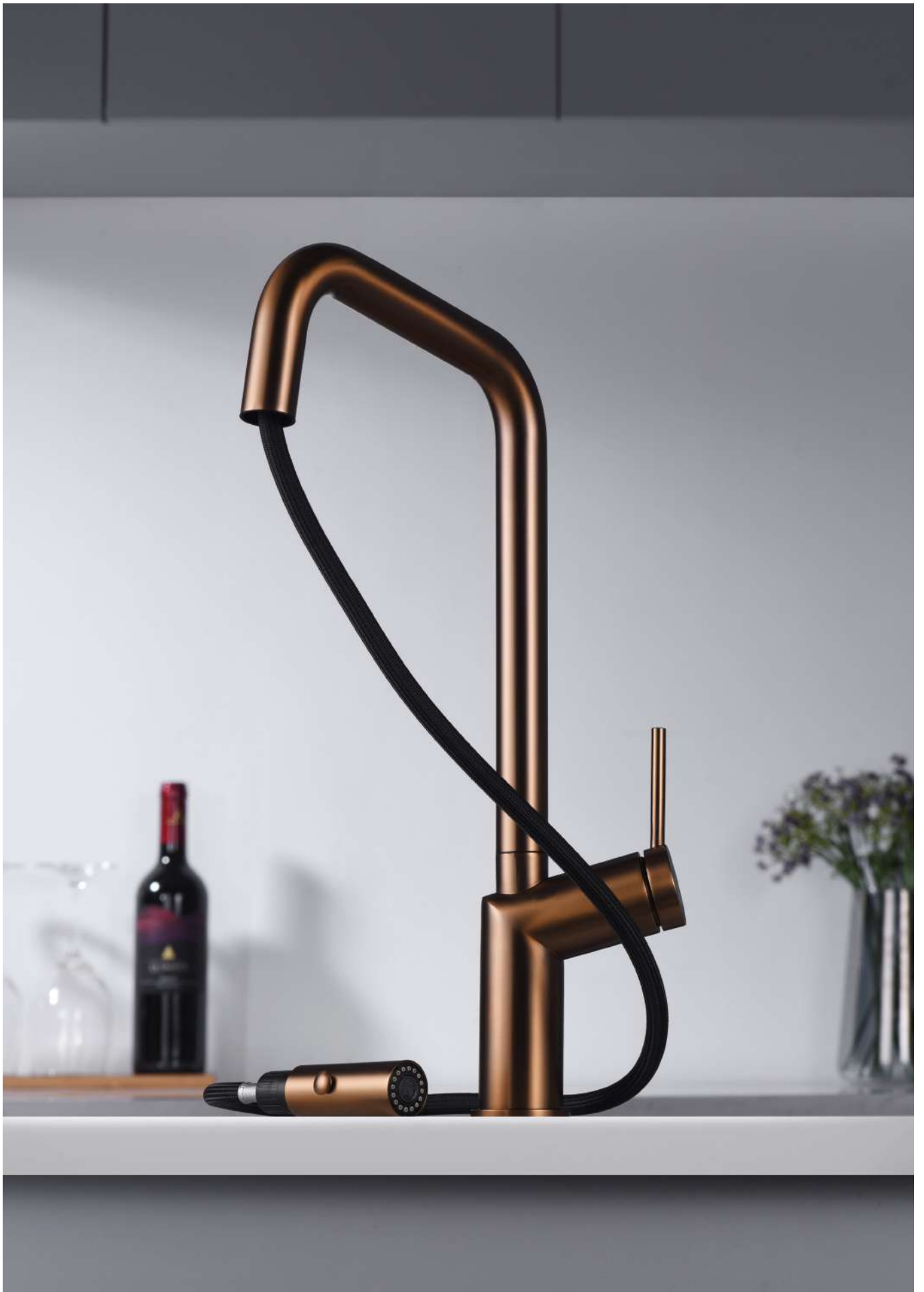

# BONN

## ROSA CEPILLADO

SERIE



## PVD COLLECTION

Ref.: GCE024/ORC

Grifería monomando extraíble.  
Cuerpo de grifería oro rosa cepillado.  
Difusor con dos funciones.  
Cartucho cerámico de Ø35 mm.  
Latiguillos 50cm.

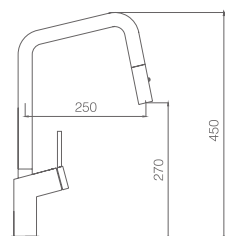

Cod.: 000161.00

Grifería con  
certificación









# TORINO CROMO

SERIE



Ref.: GCE007

Grifería monomando flexible.  
Cuerpo de grifería en latón cromado.  
Difusor con dos funciones.  
Cartucho cerámico de Ø35 mm.  
Latiguillos 50cm.

Cod.: 000160.00

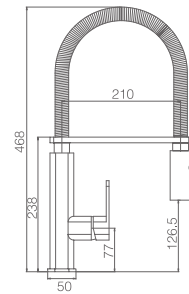

**KENIA**  
**PVD COLLECTION**  
SERIE







# KENIA CROMO

SERIE



Ref.: **GCE020**

Grifería monomando.  
Cuerpo de grifería en latón cromado.  
Cartucho cerámico de Ø35 mm.  
Latiguillos 50cm.

Cod.: 000092.00

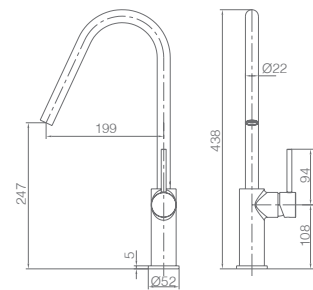

Grifería con  
certificación







# KENIA NEGRO MATE

SERIE

SISTEMA LACADO  
ELECTROFORESIS



Ref.: GCE020/NG

Grifería monomando.  
Cuerpo de grifería en latón negro mate.  
Cartucho cerámico de Ø35 mm.  
Latiguillos 50cm.

Cod.: 000099.00

Grifería con  
certificación

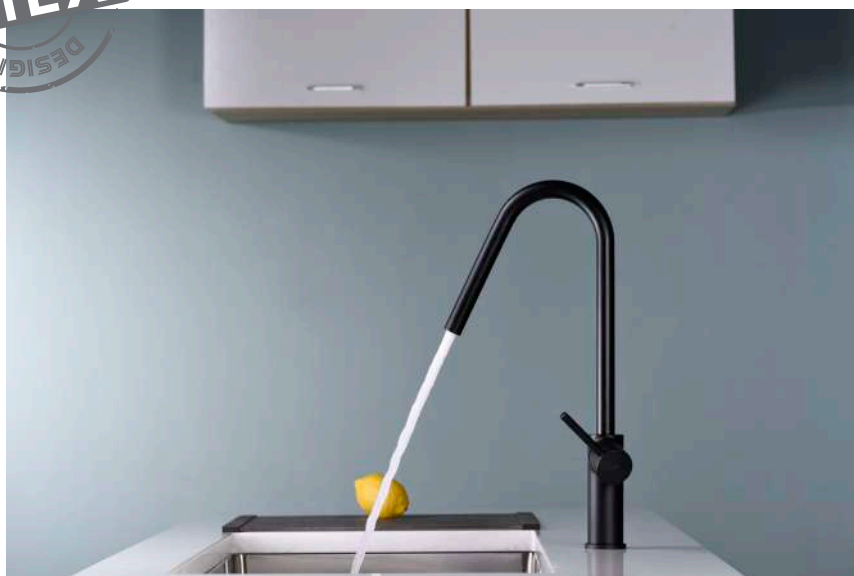
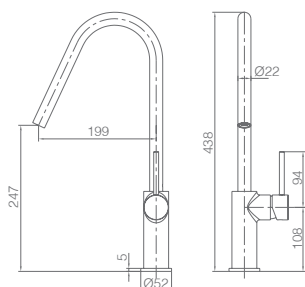

# KENIA

## NÍQUEL CEPILLADO

SERIE



Ref.: GCE020/NQ

Grifería monomando.  
Cuerpo de grifería en latón níquel cepillado.  
Cartucho cerámico de Ø35 mm.  
Latiguillos 50cm.

Cod.: 000104.00

Grifería con  
certificación

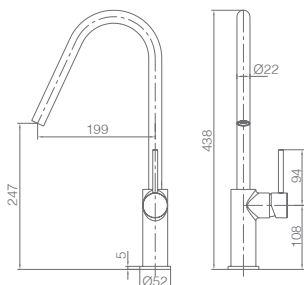

# KENIA

## ORO ROSA CEPILLADO

SERIE

# PVD

## COLLECTION



Ref.: **GCE020/ORC**

Grifería monomando.  
Cuerpo de grifería en latón oro rosa cepillado.  
Cartucho cerámico de Ø35 mm.  
Latiguillos 50cm.

Cod.: 000112.00

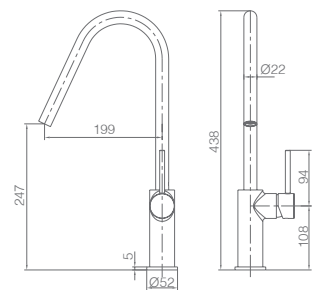

Grifería con  
certificación





# KENIA

## ORO CEPILLADO

SERIE

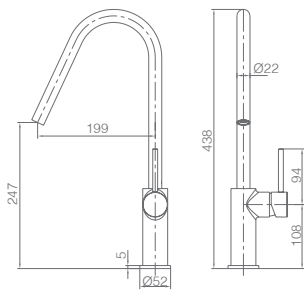

## PVD

### COLLECTION



Ref.: **GCE020/OC**

Grifería monomando.  
Cuerpo de grifería en latón oro cepillado.  
Cartucho cerámico de Ø35 mm.  
Latiguillos 50cm.

Cod.: 000112.00



# BELICE CROMO

SERIE





**Ref.: GCCH041**

Grifería monomando.  
Cuerpo de grifería latón cromado.  
Cartucho cerámico de Ø35 mm.  
Latiguillos 50cm.

**Cod.: 000190.00**

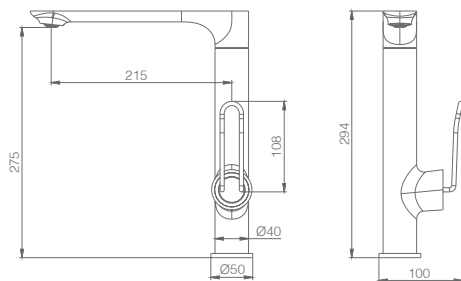



# BELICE CURVED CROMO

SERIE



Ref.: **GCRH041**

Grifería monomando extraíble.  
Cuerpo de grifería latón cromado.  
Difusor con dos funciones.  
Cartucho cerámico de Ø25 mm.  
Latiguillos 50cm.

Cod.: 000171.00

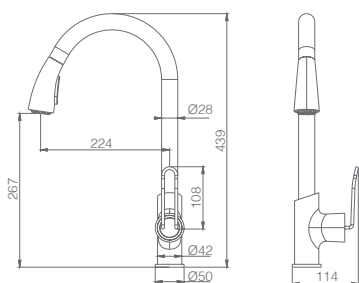





# OLIMPO CROMO

SERIE



Ref.: **GCC033**

Grifería monomando.  
Cuerpo de grifería latón cromado.  
Cartucho cerámico de Ø25 mm.  
Latiguillos 50cm.

Cod.: 000168.00

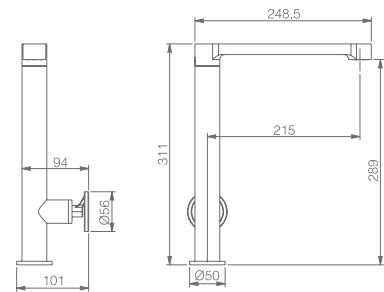

# OLIMPO

## NEGRO ORO ROSA

SERIE



Ref.: **GCC033/NOR**

Grifería monomando.  
Cuerpo de grifería latón negro oro rosa.  
Cartucho cerámico de Ø25 mm.  
Latiguillos 50cm.

Cod.: 000192.00

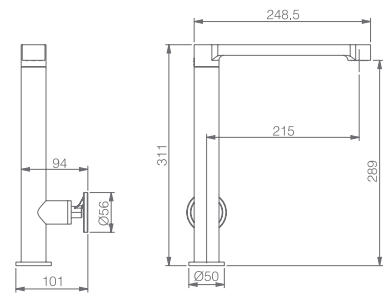

# OLIMPO NEGRO MATE

SERIE

SISTEMA LACADO  
ELECTROFORESIS



Ref.: **GCC033/NG**

Grifería monomando.  
Cuerpo de grifería latón negro mate.  
Cartucho cerámico de Ø25 mm.  
Latiguillos 50cm.

Cod.: 000189.00

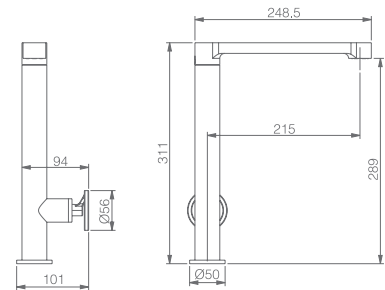



# SAMOA CROMO

SERIE

Ref.: GCE017

Grifería monomando extraíble.  
Cuerpo de grifería cromado.  
Difusor con dos funciones.  
Cartucho cerámico de Ø25 mm.  
Latiguillos 50cm.

Cod.: 000139.00

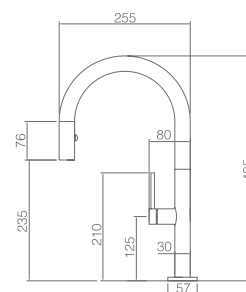



# SAMOA

## BLANCO MATE

SERIE

Ref.: GCE017/BL

Grifería monomando extraíble.  
 Cuerpo de grifería blanco mate.  
 Difusor con dos funciones.  
 Cartucho cerámico de Ø25 mm.  
 Latiguillos 50cm.

Cod.: 000152.00

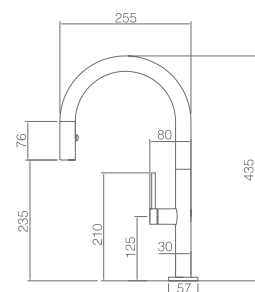





# SAMOA NEGRO MATE

SERIE

Ref.: GCE017/NG

Grifería monomando extraíble.  
Cuerpo de grifería negro mate.  
Difusor con dos funciones.  
Cartucho cerámico de Ø25 mm.  
Latiguillos 50cm.

Cod.: 000152.00



SISTEMA LACADO  
ELECTROFORESIS

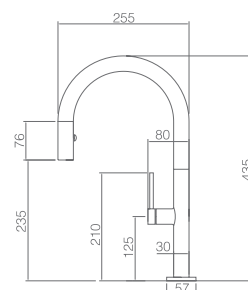



# SAMOA

## NEGRO ORO ROSA

SERIE

Ref.: GCE017/NOR

Grifería monomando extraíble.  
 Cuerpo de grifería negro oro rosa.  
 Difusor con dos funciones.  
 Cartucho cerámico de Ø25 mm.  
 Latiguillos 50cm.

Cod.: 000158.00

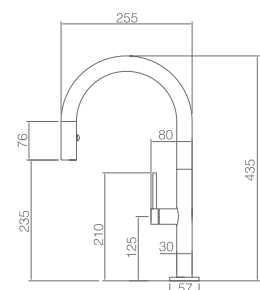



# MENORCA

## CROMO - NEGRO

SERIE



Ref: **GCE019**

Grifería monomando.  
Cuerpo de grifería en latón cromado y  
caño flexible negro mate.  
Difusor dos funciones.  
Cartucho cerámico de Ø25 mm.  
Latiguillos 50cm.

Cod.: 000138.00

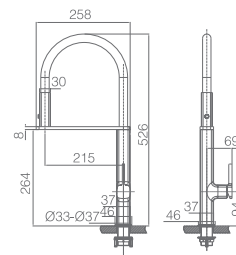

# MENORCA NEGRO MATE

SERIE

SISTEMA LACADO  
ELECTROFORESIS



Ref.: GCE019/NG

Grifería monomando.  
Cuerpo de grifería en latón negro mate y  
caño flexible negro mate.  
Difusor con dos funciones.  
Cartucho cerámico de Ø25 mm.  
Latiguillos 50cm.

Cod.: 000159.00

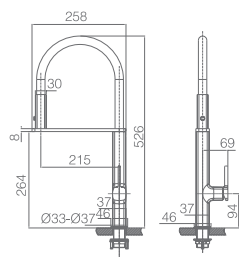





# ÍTACA CROMO

SERIE



Ref.: GCE018

Grifería monomando escamoteable.  
Cuerpo de grifería latón cromado.  
Cartucho cerámico de Ø25 mm.  
Latiguillos 50cm.

Cod.: 000158.00

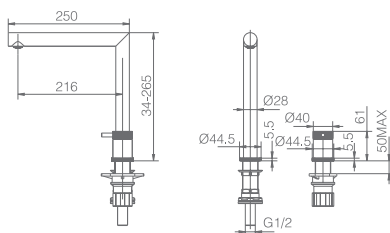

Instalación





# ÍTACA NEGRO MATE

SERIE

SISTEMA LACADO  
ELECTROFORESIS

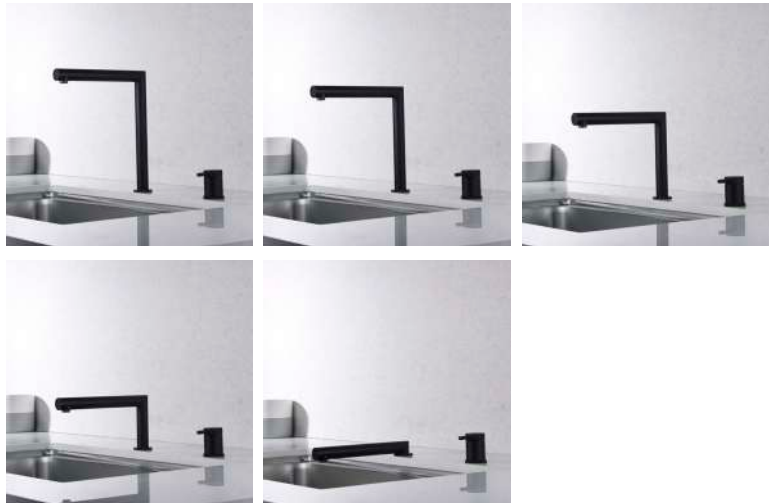

Ref.: **GCE018/NG**

Grifería monomando escamoteable.  
Cuerpo de grifería latón negro mate.  
Cartucho cerámico de Ø25 mm.  
Latiguillos 50cm.

Cod.: 000164.00

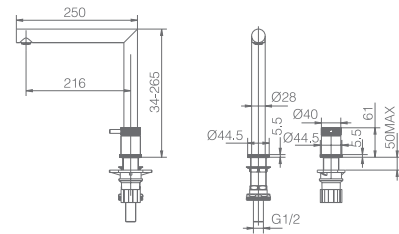





# MANACOR CROMO

SERIE

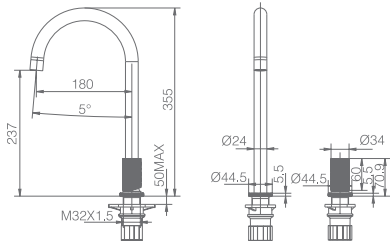

Ref.: **GCM001**

Grifería monomando.  
Cuerpo de grifería latón cromado.  
Cartucho cerámico de Ø25 mm.  
Latiguillos 50cm.  
Aireador rótula no incluido.

Cod.: 000138.00



Opcional, ver página 165 del catálogo



# MANACOR NEGRO MATE

SERIE



Opcional, ver página 165 del catálogo



SISTEMA LACADO  
ELECTROFORESIS

Ref.: **GCM001/NG**

Grifería monomando.  
Cuerpo de grifería latón negro mate.  
Cartucho cerámico de Ø25 mm.  
Latiguillos 50cm.  
Aireador rótula no incluido.

Cod.: 000142.00

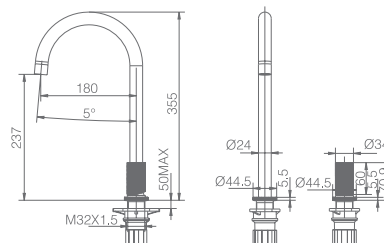

# MANACOR

## BLANCO MATE

SERIE



Ref.: **GCM001/BL**

Grifería monomando.  
Cuerpo de grifería latón blanco mate.  
Cartucho cerámico de Ø25 mm.  
Latiguillos 50cm.

Cod.: 000142.00

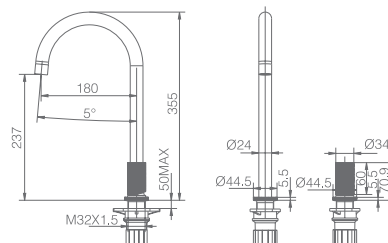

# LANZAROTE

## CROMO - NEGRO

SERIE

### Ref.: GCE015

Grifería monomando.  
Cuerpo de grifería en latón cromado y  
caño flexible negro mate.  
Difusor con dos funciones.  
Cartucho cerámico de Ø25 mm.  
Latiguillos 50cm.

Cod.: 000155.00

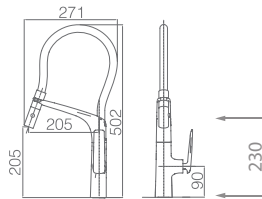







# TOULOUSE

## CROMO

SERIE



### Ref.: GCE008

Grifería monomando flexible.  
Cuerpo de grifería en latón cromado  
con caño flexible.  
Difusor con 2 funciones.  
Cartucho cerámico de Ø35 mm.  
Latiguillos 50cm.

Cod.: 000174.00

Grifería con  
certificación

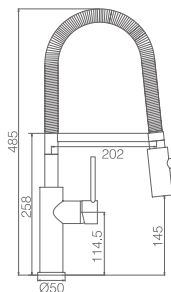

Flexible 50 cm

# LAOS

SERIE

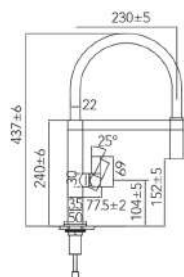

Altura mínima 37 cm



Ref.: **GCE011**

Grifería monomando flexible.  
Cuerpo de grifería en latón cromado.  
Cartucho cerámico de Ø25 mm.  
Latiguillos 50cm.

Cod.: 000146.0



Ref.: **GCE012**

Grifería monomando flexible.  
Cuerpo de grifería en latón negro mate.  
Cartucho cerámico de Ø25 mm.  
Latiguillos 50cm.

Cod.: 000165.00

SISTEMA LACADO  
ELECTROFORESIS



Ref.: **GCE014**

Grifería monomando flexible.  
Cuerpo de grifería en latón blanco mate.  
Cartucho cerámico de Ø25 mm.  
Latiguillos 50cm.

Cod.: 000146.00





# VENECIA

## CROMO

SERIE



Ref.: **GCE100**

Grifería monomando.  
Cuerpo de grifería en latón cromado.  
Cartucho cerámico de Ø35 mm.  
Latiguillos 50cm.

Cod.: 000092.00

Grifería con  
certificación

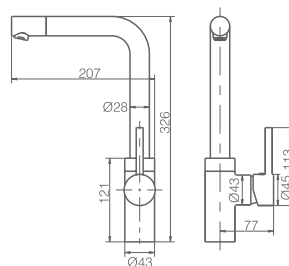





IMEX

IMEX

# CONSTANZA

## CROMO

SERIE



Ref.: GCE005

Grifería monomando extraíble.  
Cuerpo de grifería latón cromado.  
Cartucho cerámico de Ø35 mm.  
Latiguillos 50cm.

Cod.: 000173.00

Grifería con  
certificación

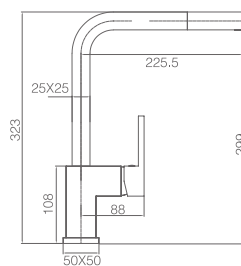



# PIREO CROMO

SERIE



Ref.: **GOS003**

Grifería monomando de dos vías (ósmosis)  
Cuerpo de grifería en Latón cromado.  
Cartucho cerámico de Ø35 mm.  
Latiguillos 50cm.

Cod.: 000131.00

Grifería con  
certificación

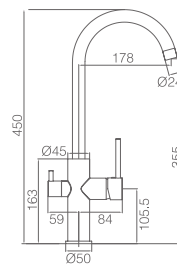

# Ósmosis



# Ósmosis



# CAPRI CROMO

SERIE



Ref.: **GOS002**

Grifería monomando de dos vías (ósmosis)  
Cuerpo de grifería en latón cromado.  
Cartucho cerámico de Ø35 mm.  
Latiguillos 50cm.

Cod.: 000163.00

Grifería con  
certificación

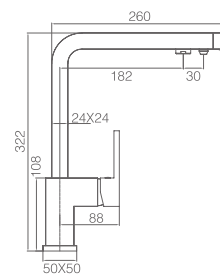



Ósmosis



SISTEMA LACADO ELECTROFORESIS

Ref.: GOS002/NG

Grifería monomando de dos vías (ósmosis)  
 Cuerpo de grifería en latón negro mate.  
 Cartucho cerámico de Ø35 mm.  
 Latiguillos 50cm.

Cod.: 000171.00

Grifería con certificación

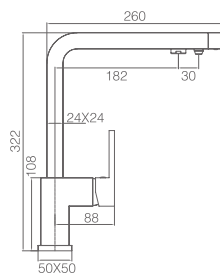

# CAPRI NEGRO MATE

SERIE

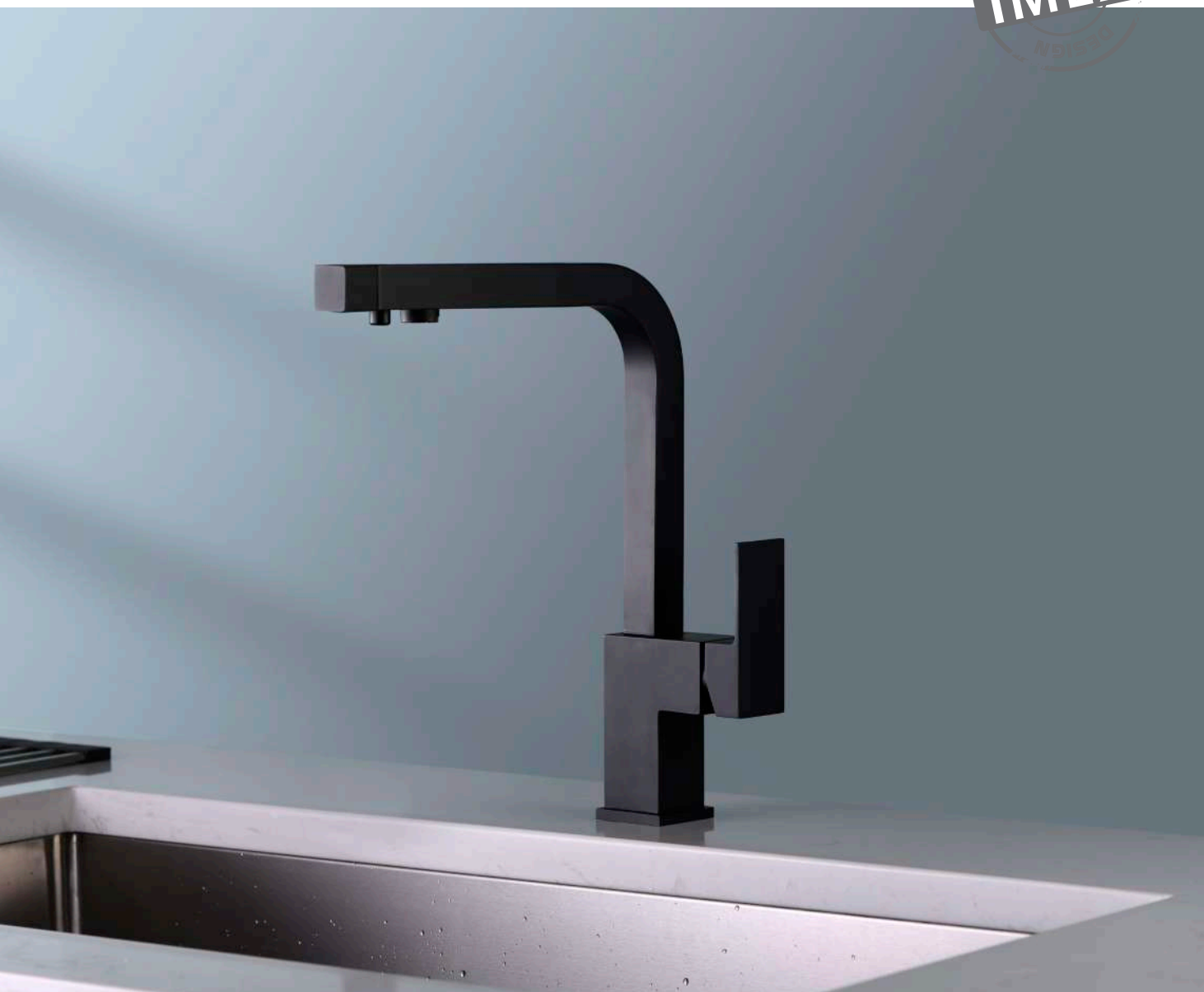

# MONTECARLO CROMO

SERIE



Instalación

Ref.: **GOS001**

Grifería monomando de dos vías (ósmosis)  
Cuerpo de grifería en latón cromado.  
Cartucho cerámico de Ø40 mm.  
Latiguillos 50cm.

Cod.: 000158.00

Grifería con  
certificación

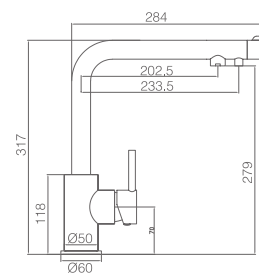

# Ósmosis





# MARSELLA

## CROMO

SERIE



Ref.: **GOS004**

Grifería monomando de dos vías (ósmosis)  
Cuerpo de grifería en latón cromado.  
Cartucho cerámico de Ø35 mm.  
Latiguillos 50cm.

Cod.: 000144.00

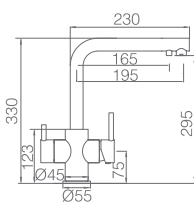

# Ósmosis



# MARSELLA

## NEGRO MATE

SERIE



SISTEMA LACADO  
ELECTROFORESIS



Ref.: **GOS004/NG**

Grifería monomando de dos vías (ósmosis)  
Cuerpo de grifería en latón cromado.  
Cartucho cerámico de Ø35 mm.  
Latiguillos 50cm.

Cod.: 000169.00

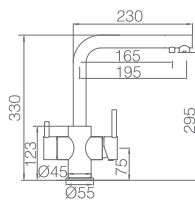

Ósmosis





# LYON CROMO

SERIE



Opcional, ver página 165 del catálogo



Ref.: **GCR002**

Grifería monomando.  
Cuerpo de grifería en latón cromado.  
Cartucho cerámico de Ø35 mm.  
Latiguillos 50cm.  
Aireador rótula no incluido.

Cod.: 000060.00

Grifería con  
certificación



< Instalación

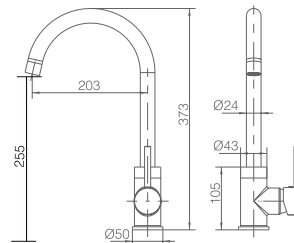

# LYON NEGRO MATE

SERIE



Opcional, ver página 165 del catálogo

SISTEMA LACADO  
ELECTROFORESIS

Ref.: GCR002/NG

Grifería monomando.  
Cuerpo de grifería en latón cromado.  
Cartucho cerámico de Ø35 mm.  
Latiguillos 50cm.  
Aireador rótula no incluido.

Cod.: 000068.00

Grifería con  
certificación



< Instalación

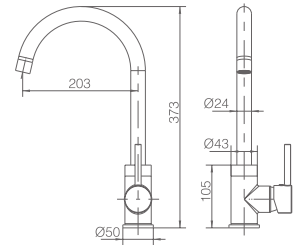







# COX CROMO

SERIE



Ref.: GCC001

Grifería monomando.  
Cuerpo de grifería en latón cromado.  
Giro 360°  
Cartucho cerámico de Ø35 mm.  
Latiguillos 50cm.

Cod.: 000129.00

Grifería con  
certificación

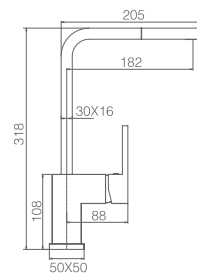

# VERONA

## CROMO - NEGRO

SERIE

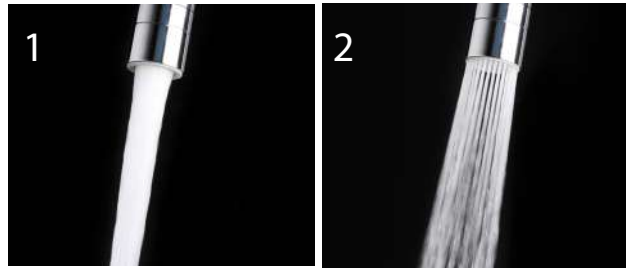

Ref.: GCE010

Grifería monomando.  
Cuerpo de grifería en latón cromado y  
tubo flexible en negro mate.  
Cartucho cerámico de Ø35 mm.  
Difusor con dos posiciones.  
Latiquillos 50 cm.

Cod.: 000083.00

Test de la grifería  
aprobado

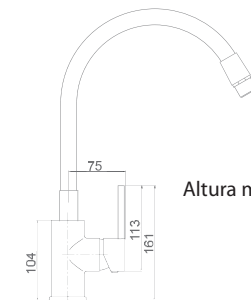

Altura mínima 24 cm





PROFESSIONAL  
**IMEX**  
DESIGN



# VIENA

## CROMO - BLANCO

SERIE

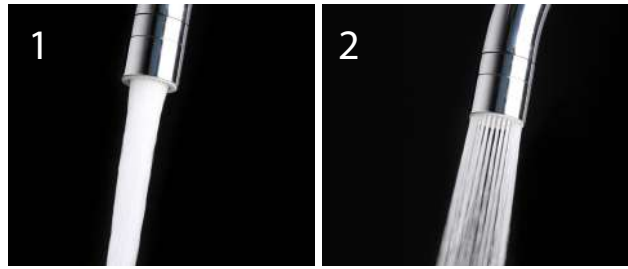

Ref.: GCE009

Grifería monomando.  
Cuerpo de grifería en latón cromado y  
tubo flexible en blanco mate.  
Cartucho cerámico de Ø35 mm.  
Difusor con dos posiciones.  
Latiguillos 50cm.

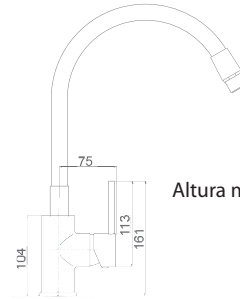

Altura mínima 24 cm

Cod.: 000083.00

Test de la grifería  
aprobado



# TOKYO

## CROMO - NEGRO

SERIE

### Ref.: GCE016

Grifería monomando.  
Cuerpo de grifería en latón cromado y tubo flexible en negro mate.  
Cartucho cerámico de Ø35 mm.  
Aireador de dos posiciones.  
Latiguillos 50 cm.

Apertura en frío

Cod.: 000122.00

Test de la grifería  
aprobado



SISTEMA DE  
AHORRO  
ENERGÉTICO

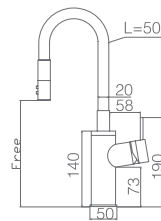

Altura máxima  
recomendada 47 cm







# COMPLEMENTOS

---





**Ref.: RR0031**

Aireador rótula M22x, con dos funciones.  
Material: ABS  
Acabado: Cromo

Cod.: 000005.90



**Ref.: RR0031/BGM**

Aireador rótula M22x, con dos funciones.  
Material: ABS  
Acabado: Black gun metal

Cod.: 000009.50



**Ref.: RR0031/NG**

Aireador rótula M22x, con dos funciones.  
Material: ABS  
Acabado: Negro mate

Cod.: 000006.50



**Ref.: RR0031/OC**

Aireador rótula M22x, con dos funciones.  
Material: ABS  
Acabado: Oro cepillado

Cod.: 000008.50



**Ref.: RR0031/ORC**

Aireador rótula M22x, con dos funciones.  
Material: ABS  
Acabado: Oro rosa cepillado

Cod.: 000009.00

# **INSTRUCCIONES DE MONTAJE**

---



## Instrucciones de instalación de grifos de cocina extraíbles



Paso 2. Asegúrese de que el grosor de la cubierta no supere los 50 mm.



Paso 3. Conecte la manguera de entrada



Paso 4. Instalar la pieza de reparación en orden



Paso 5. Conectar la bola de gravedad.



Paso 6. Conecte la manguera de entrada con agua caliente y fría según la marca

1	tubo de grifo*1
2	manguera de entrada*2
3	tornillo de plástico*1
4	junta de plástico / acero*1
5	pieza de plástico*1
6	bola de gravedad*1

Paso 1. Revisar todas las piezas de repuesto listas

## Instrucciones de instalación de grifos de cocina de agua potable (ósmosis)

Maneta para agua potable

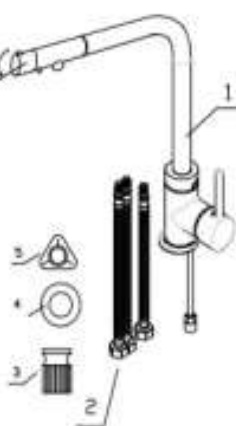

Paso 2. Asegúrese de que el grosor de la cubierta no supere los 50 mm.



Paso 3. Instalar la pieza de reparación en orden



Paso 4. Conecte la manguera de entrada



Paso 5. Conecta la manguera de agua potable

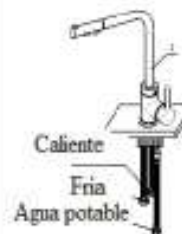

Paso 6. Conecte la manguera de entrada

1	tubo de grifo*1
2	manguera de entrada de agua potable*3
3	tornillo de plástico*1
4	junta de plástico / acero*1
5	pieza de plástico*1

Paso 1. Revisar todas las piezas de repuesto listas



# EXPOSITORES



Ref.: 1EXP0005  
(opción blanco y negro)



Ref.: 1EXP0014-N

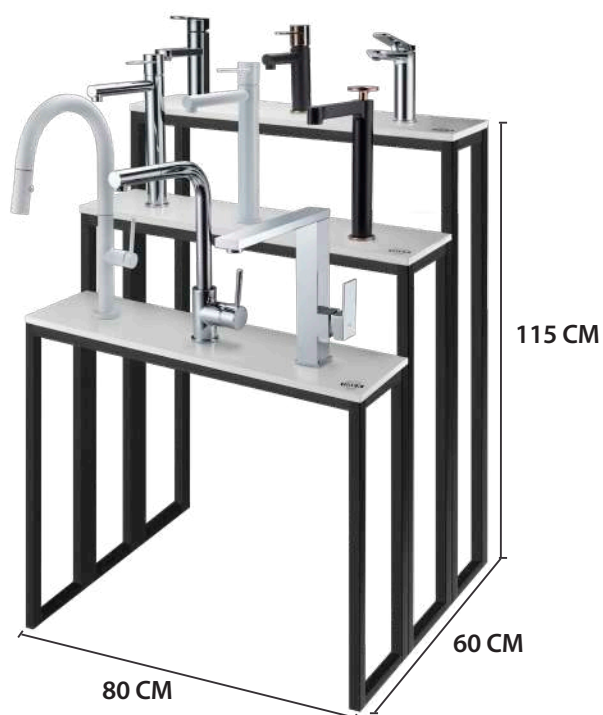

Ref.: 1EXP0022



Ref.: 1EXP0023 (8 Grifos)



Ref.: 1EXP0024 (14 Grifos)

# CONDICIONES GENERALES DE VENTA

## ENTREGAS

Revise la mercancía a la recepción de la misma. No se aceptará ninguna reclamación sobre mercancía no revisada en el momento de su recepción. El transportista indicará tal efecto en el albarán de entrega.

## DEVOLUCIONES

En caso de devolución defina claramente el motivo de la misma.

IMEX aceptará toda devolución que cumpla las siguientes premisas:

- El material deberá tener algún defecto de fabricación.
- El embalaje deberá estar en perfecto estado, de no ser así se le aplicará un recargo de un 10% en factura en concepto de recepción, revisión y manipulación.

## FORMA DE PAGO

Se emitirá recibo a través de entidad bancaria.

Giro máximo 30 días fecha factura.

Cualquier impagado que se produzca conllevará el pago de la factura más todos los gastos bancarios ocasionados y retención de todos los pedidos hasta el pago del mismo.

## TRIBUNALES

En caso de litigio ambas partes se someterán a los tribunales de Picassent (VALENCIA).

## PORTES

Para los pedidos a entregar en la península que no superen los 80€, se cargarán 6,50 € de portes. Para otros destinos consultar con fábrica o comercial.

# ACTUALIZACIÓN Y MANTENIMIENTO DE LAS COLECCIONES

## CAMBIOS EN EL MODELAJE

En ciertas ocasiones, algunos de los artículos suministrados por IMEX PRODUCTS, S.L., pueden presentar cambios, no sustanciales, en algunos de sus componentes en relación a las fotografías publicadas en catálogo actual.

IMEX PRODUCTS, S.L. se reserva el derecho de efectuar dichos cambios en su modelaje siempre en aras de una mejora tanto del diseño y funcionalidad del producto, como de sus condiciones de venta.

# CONSEJOS DE LIMPIEZA Y MANTENIMIENTO

En Imex Products aconsejamos que para realizar la limpieza de nuestra grifería, en acabados negro mate o blanco mate, se utilicen productos no abrasivos y con un Ph neutro, evitando, de este modo, dañar las piezas.

Siguiendo las indicaciones o recomendaciones del fabricante del producto, aconsejamos la utilización de bayeta de microfibra en el proceso de limpieza, finalizando con el secado de las piezas. De esta forma conseguiremos alargar la vida de la grifería.

Video demostrativo



# IMEX

PRODUCTS

IMEX PRODUCTS, S.L.

Pol. Ind. Picassent  
C/ 6 Parcela 11  
46220 Picassent (Valencia) - Spain

Tlfs. de contacto:

T.: +34 96 065 12 74

T.: +34 96 156 63 87

T.: +34 63 040 29 47

Mails:

(Pedidos) [imex@imexproducts.es](mailto:imex@imexproducts.es)

(Consultas) [consultas@imexproducts.es](mailto:consultas@imexproducts.es)

(Servicio Técnico) [sat@imexproducts.es](mailto:sat@imexproducts.es)

(Contabilidad) [contabilidad@imexproducts.es](mailto:contabilidad@imexproducts.es)

[www.imexproducts.es](http://www.imexproducts.es)