

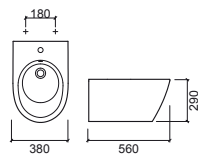

SANLIFE

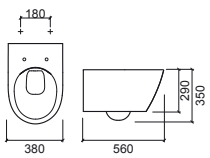
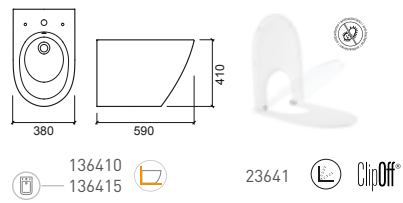
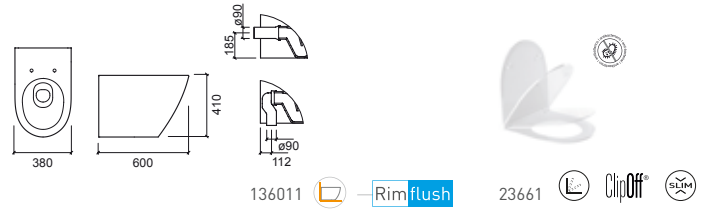
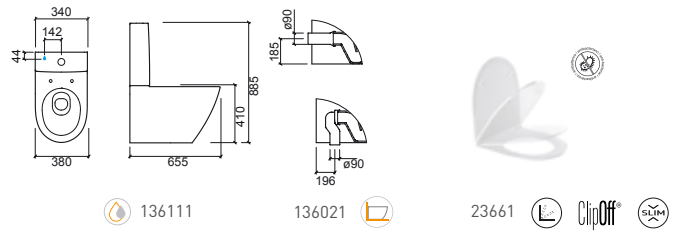

136032 Rimflush

23661 ClipOff® SLIM

136450 136455

23641 ClipOff®



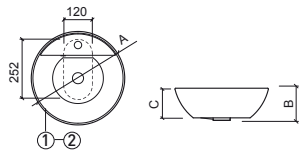

	A	B
① 136370	38	145
② 136770	42	145

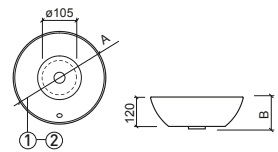

	A	B
① 136379	38	130
② 136779	42	130

	A	B	C	D
① 136330	60	600	350	252
② 136730	60	602	400	250

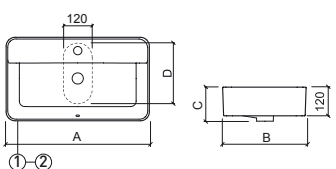

	A	B	C	D
① 136900	60	600	350	285
② 136910	60	602	400	285

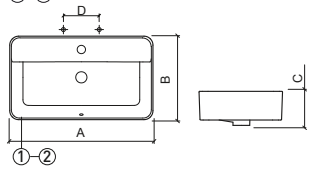

	A	B	C	D
① 136339	60	602	352	122
② 136739	60	602	400	122
③ 136349	80	800	350	140
④ 136749	80	800	400	144

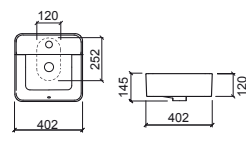
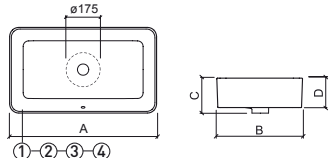

136720

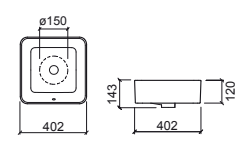

136729

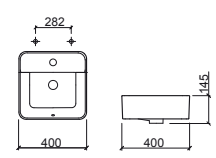

136950

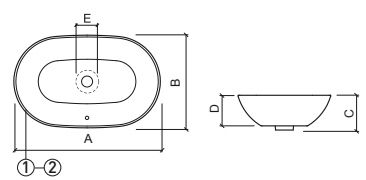

	A	B	C	D	E
① 136389	60	595	380	140	180
② 136789	60	600	420	142	150

SANIBOLD

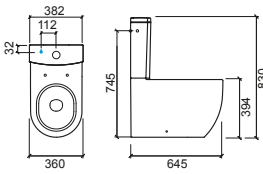

137111
137113

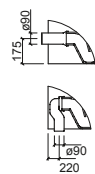

137021

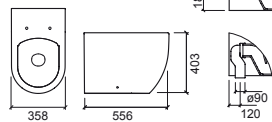

137011



23731



23761

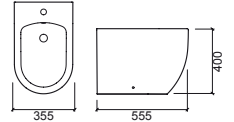

137410

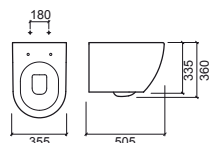

137034

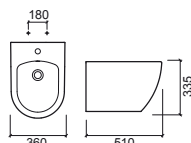

137440

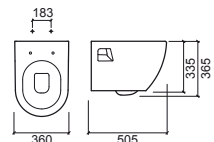

137032

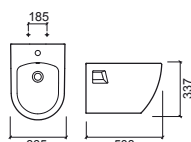

137450



Acabados mate

* Interior blanco brillo / Exterior color mate. Colores y acabados mate, bajo pedido.

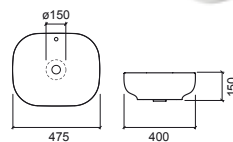

137300

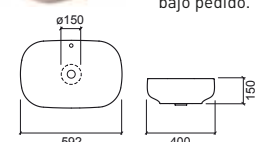

137310

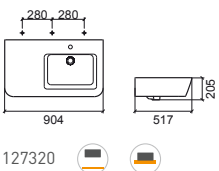
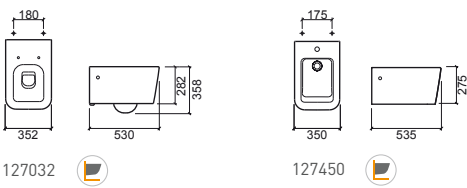
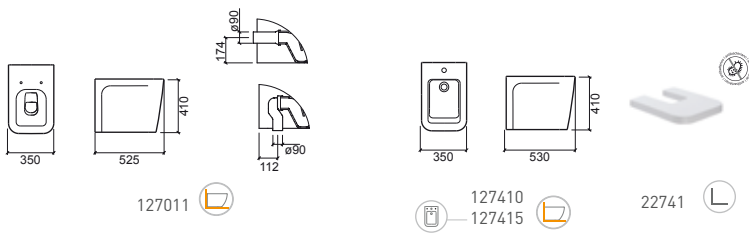

WINNER

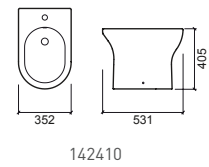
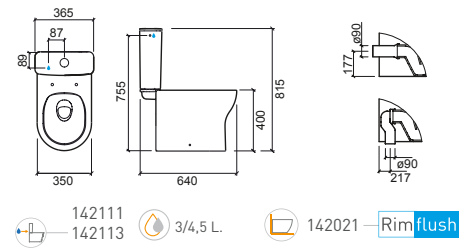
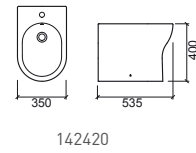
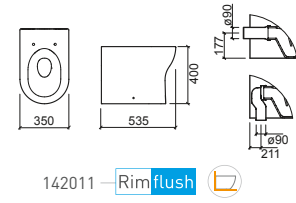
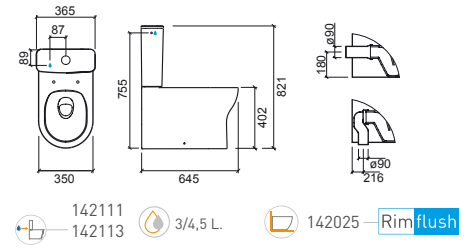

24231 easy clip

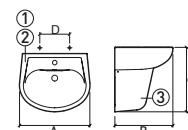

	A	B	C	D
① 142300	55	559	435	509
② 142310	60	608	458	509
③ 142220				278

URB.Y PLUS

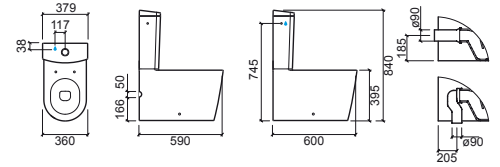

140171
140173

146021

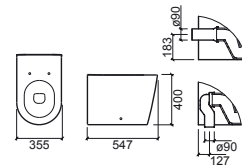

146011



24011



ClipOff®



24031



ClipOff®



24061



easy clip

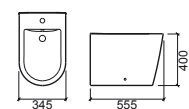

146410
146415



24041



URB.Y

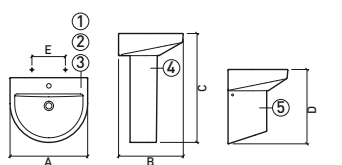
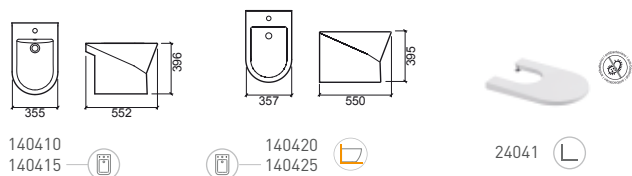
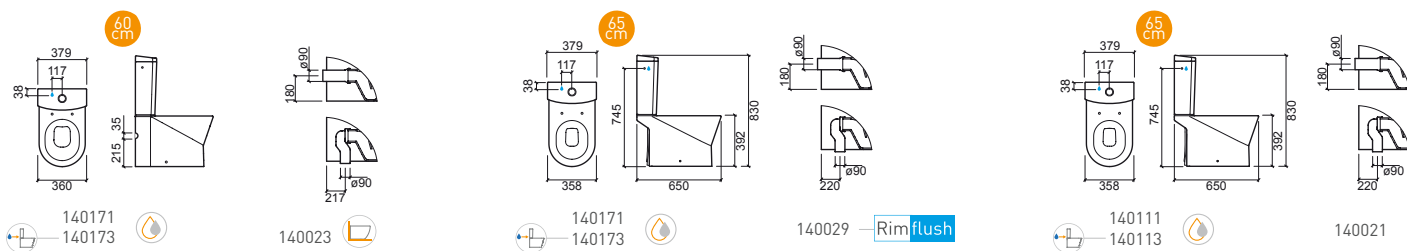

	A	B	C	D	E
① 140300	56	560	465	835	580 280
② 140310	60	600	500	835	585 280
③ 140320	66	660	490	835	585 280
④ 140200					
⑤ 140220					



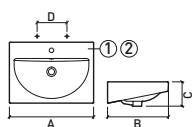

	A	B	C	D			
①	140350	65	650	470	190	280	
②	140360	80	800	470	195	280	

48 cm

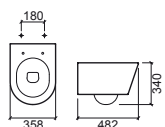

140032

48 cm

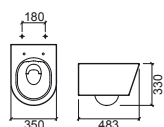

140034 Rimflush

48 cm

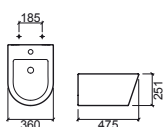

140450

52 cm

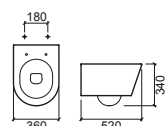

140042

52 cm

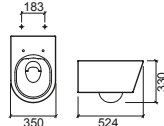

140044 Rimflush

52 cm

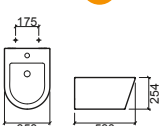

140440



24011 ClipOff® 24031 ClipOff® 24061 easy clip



LOOK

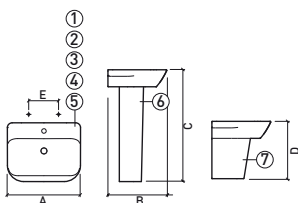
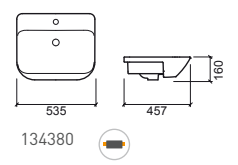
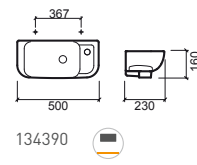
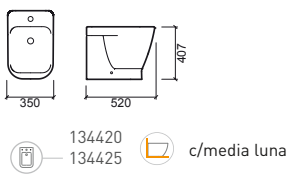
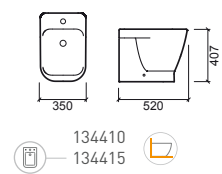
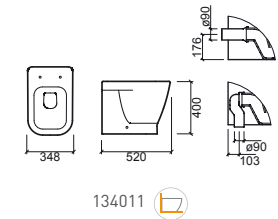
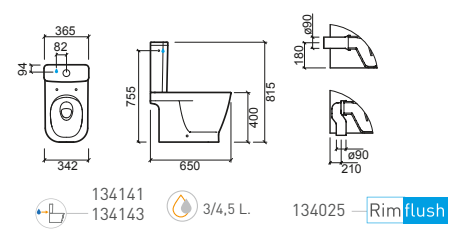
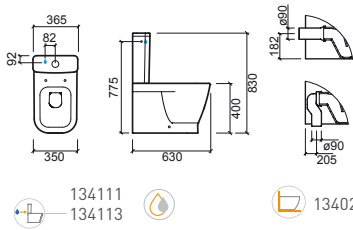
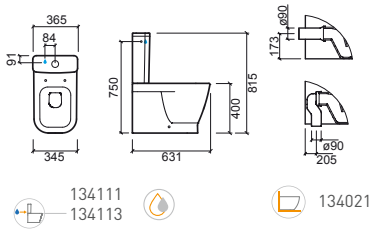

	A	B	C	D	E		
①	134310	46	460	416	850	440	228
②	134320	50	500	414	850	440	280
③	134330	56	560	449	850	440	280
④	134340	60	600	449	850	440	280
⑤	134370	66	660	443	850	444	278
⑥	134200						
⑦	134220						

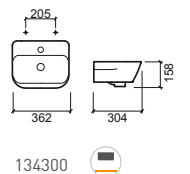
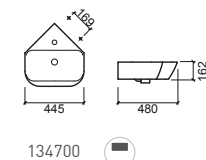

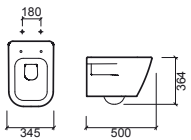

134032

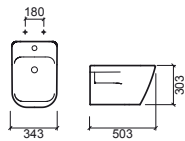

134450
134455

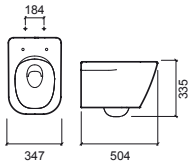

134034 Rimflush

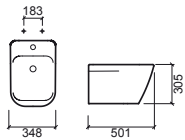

134440
134445

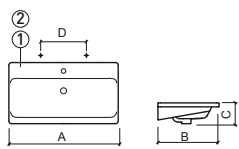

	A	B	C	D
① 134350	63	637	465	168
② 134360	83	832	465	177

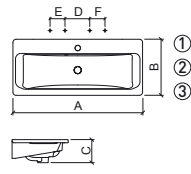

	A	B	C	D	E	F
① 134770	63	630	360	148	280	---
② 134780	83	830	360	148	280	---
③ 134790	103	1030	360	148	280	140

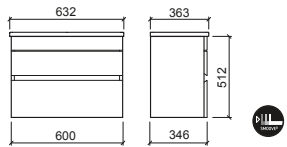

	A	B	C
63430	63	600	500
63431	83	800	500
63440	103	1000	500

	A	B	C
63420	63	630	500
63421	83	830	500

blanco



EASY

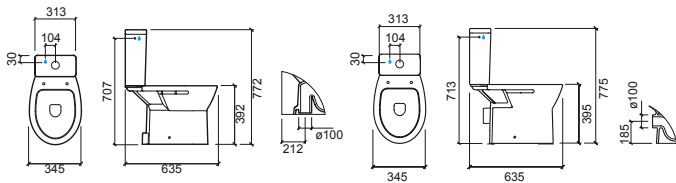

131111 131021 131111 131022
 131113 131113 131113 131022



23114 23121 L 23131 L

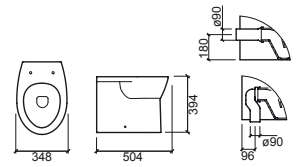

131013

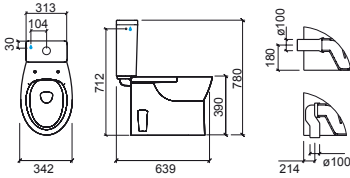

131111 131023 Rimflush
 131113

131141 3/4,5 L
 131143



131420 23141 L 131410 131415

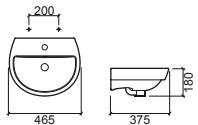

131300

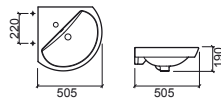

131700

	A	B	C	D	E
① 131330	50	500	425	845	415 245
② 131310	55	548	443	846	415 272
③ 131320	60	612	467	845	415 280
④ 131200					
⑤ 131220					

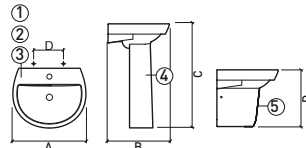

WC KIDS

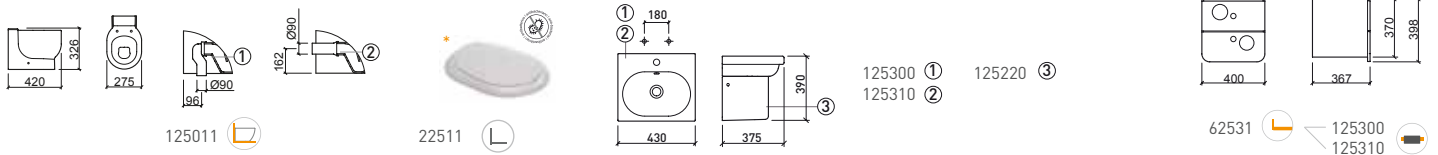

* amarillo azul

BABYBATH

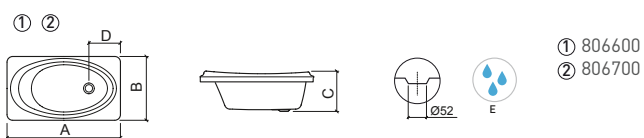

	A	B	C	D	E	
① 80	800	450	255	213	Ø52	4V9411 4V9111 4V9211
② 100	1000	500	255	221	Ø52	4V9411 4V9111 4V9211

PROGET CONFORT

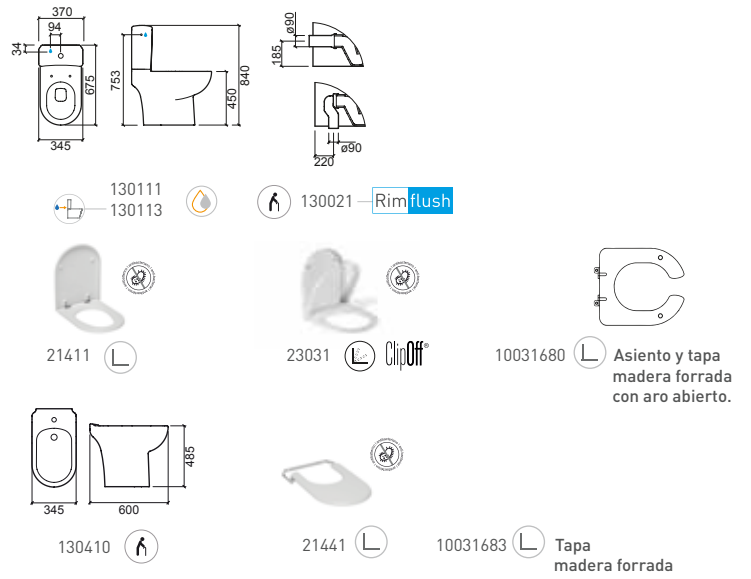

BENISSA CONFORT

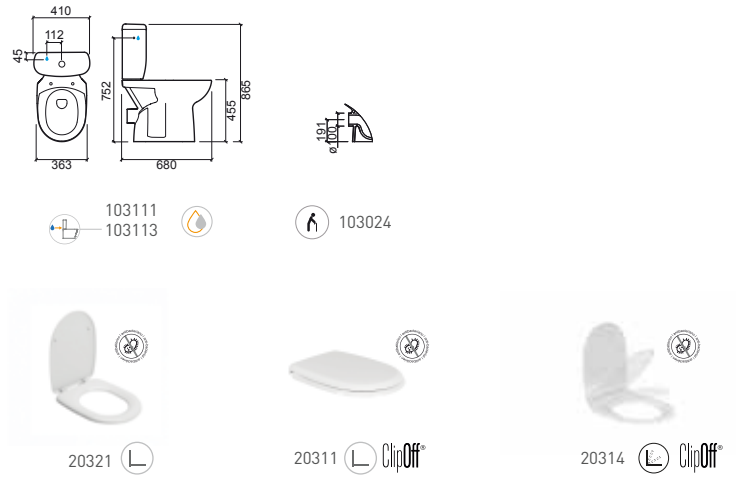

BENISSA SUSP. 70

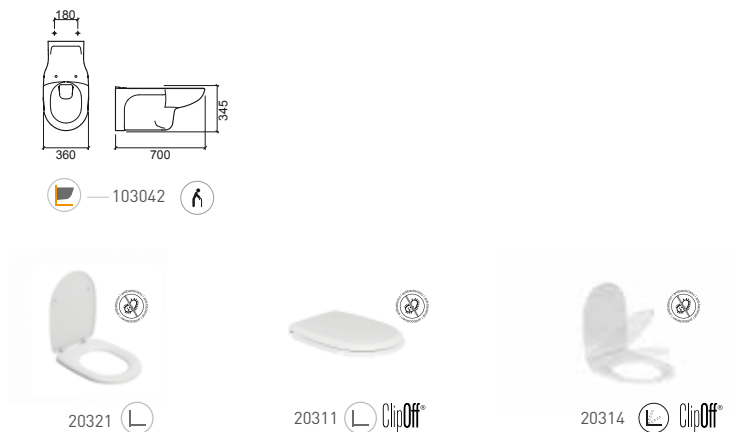

WINNER CONFORT

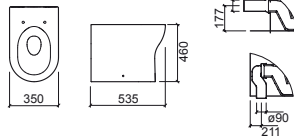
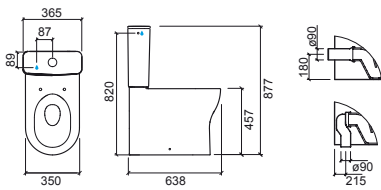

142111 142113 3/4,5 L. 144021 Rimflush

144011 Rimflush

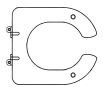

10041680 Asiento y tapa madera forrada con aro abierto.

NEW WCCARE

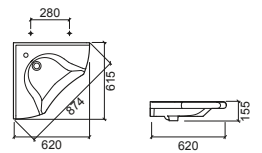
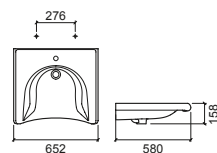
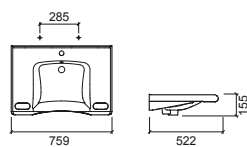
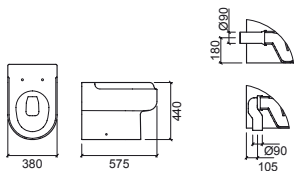

129011

129330

129320

129700



Rimflush

the ultimate hygiene

El sistema de descarga Rimflush, se caracteriza por la distribución uniforme del agua que, a través de su fuerza, efectúa un lavado perfecto y sin salpicaduras del interior del inodoro. La ausencia del marco cerrado convencional permite la limpieza fácil en las zonas difíciles del inodoro, garantizando así una mejora significativa en la higiene y una mayor eficiencia de la descarga.



Slowclose es un sistema de caída amortiguada que ofrece ventajas en la reducción del ruido y el desgaste de los materiales al minimizar el impacto de la tapa inodoro en el inodoro o el bidé. En el caso de los niños, también previene los accidentes, convirtiéndose así en una solución segura y cómoda para el uso diario.



Los sistemas de doble descarga permiten el ahorro de agua. Nuestras cisternas están equipadas con mecanismos que permiten descargas de 3/6L. ó de 3/4,5L.



Las tapas de los inodoros con mecanismo Easyclip permiten la colocación y retirada inmediata sin necesidad de utilizar herramientas. Con un simple movimiento vertical es posible soltarlo rápidamente, facilitando la tarea de limpieza.



Todas nuestras tapas de inodoro y bidé en Duroplast, proporcionan una protección antibacteriana permanente gracias a una sustancia que es incorporada a la materia prima que impide el desarrollo de bacterias y durante toda la vida del producto. Las rutinas y prácticas de limpieza deben mantenerse para garantizar su eficacia.



El sistema Clipoff permite quitar y poner la tapa del inodoro rápidamente. Viene equipado con dos botones laterales que permiten retirarlo sin necesidad de aflojar ningún herraje. Esto facilita la limpieza e higiene íntegra de la pieza y sin esfuerzo.



Back to Wall



Suspendido



Cisterna con doble descarga



Entrada de agua lateral



Entrada de agua



Personas con movilidad reducida



Senior - tercera edad



Lavabo sobre mueble



Con orificios para tapa



Asientos y tapas



Lavabo sobre encimera



Lavabo de semi-encastar



Lavabo de pared



Sin orificio para grifería



UNISAN XXI, S.A.

Avda. Mas de l'Oli, 64 · Polígono Industrial La Cova · 46940 MANISES (Valencia) España
tel. +34 961 545 700
unisan@unisan.es · www.unisan.es · www.tec.sanindusa.pt

sanindusa
GRUPO



unisan



STEPIN

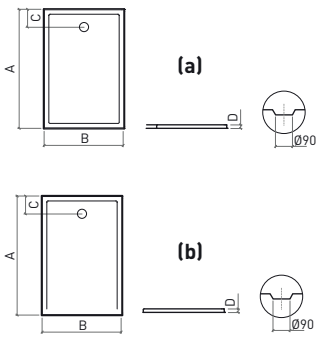

		A	B	C	D	
(a)	107520AD	80	800	800	180	35 49911
(b)	107530AD	90	900	900	180	30 49911
(a)	107562AD	100	1000	700	180	30 49911
(a)	107542AD	100	1000	800	180	30 49911
(a)	107572AD	120	1200	700	180	30 49911
(b)	107552AD	120	1200	800	180	30 49911
(b)	107612AD	120	1200	900	250	30 49911
(b)	107622AD	140	1400	700	250	30 49911
(b)	107632AD	140	1400	800	250	30 49911
(b)	107642AD	140	1400	900	250	30 49911

(a) borde 4 lados

(b) borde 3 lados

Colores disponibles



Blanco, Gris, Negro, antideslizante: C2 (exclusivamente acabado blanco)





WATERLINE

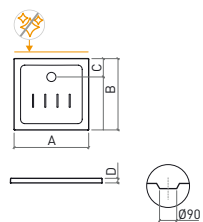

		A	B	C	D	
107470	80	800	800	180	50	49911
107780	90	900	900	220	45	49911

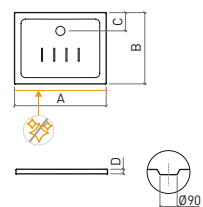

		A	B	C	D	
107442	90	900	700	185	45	49911
107452	100	1000	700	185	45	49911
107462	120	1200	700	180	45	49911
107512	140	1400	700	175	45	49911

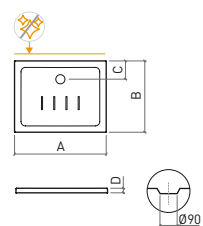

		A	B	C	D	
107722	100	1000	800	220	45	49911
107732	100	1000	900	220	45	49911
107742	120	1200	800	220	45	49911
107752	120	1200	900	220	45	49911



MORAIRA

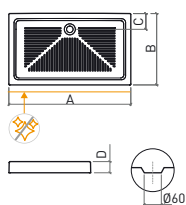

		A	B	C	D	
107182	90	900	720	250	110	49511
107192	100	1000	700	155	110	49511
107202	120	1200	700	160	110	49511
107212	120	1200	800	250	110	49511

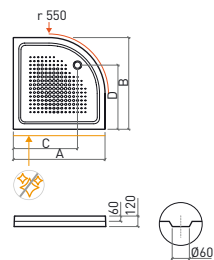

		A	B	C	D	
107221	80	800	800	530	530	49511
107231	90	900	900	630	630	49511

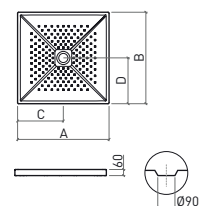

		A	B	C	D	
107245	80	800	800	400	400	49911
107255	90	900	900	450	450	49911

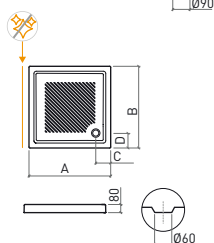

		A	B	C	D	
107150	70	700	700	150	150	49511
107160	75	750	750	145	145	49511
107170	80	800	800	150	150	49511

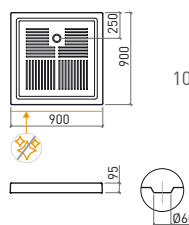

107250 49511

PIANO

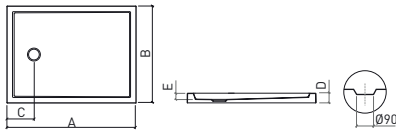

49911

D = 3,5		D = 7,5		A	B	C	E
803580	803620	80	800	800	200	45	
803590	803630	90	900	900	200	45	
803610	803640	100	1000	1000	200	50	
802720	803070	100	1000	700	250	50	
802730	803080	100	1000	750	250	45	
802740	803090	100	1000	800	250	45	
802750	803110	100	1000	900	250	45	
802760	803120	120	1200	700	250	45	
802770	803130	120	1200	750	250	45	
802780	803140	120	1200	800	250	45	
802790	803150	120	1200	900	250	45	
802810	803160	130	1300	700	250	45	
802820	803170	130	1300	750	250	45	
802830	803180	130	1300	800	250	45	
802840	803190	130	1300	900	250	45	
802850	803210	140	1400	700	250	45	
802860	803220	140	1400	750	250	45	
802870	803230	140	1400	800	250	45	
802880	803240	140	1400	900	250	45	

D = 3,5		D = 7,5		A	B	C	E
802890	803250	150	1500	700	250	60	
802910	803260	150	1500	750	250	60	
802920	803270	150	1500	800	250	60	
802930	803280	150	1500	900	250	60	
802940	803290	160	1600	700	250	60	
802950	803310	160	1600	750	250	55	
802960	803320	160	1600	800	250	55	
802970	803330	160	1600	900	250	55	
803470	803490	170	1700	700	250	45	
803480	803510	170	1700	750	250	55	
802980	803340	180	1800	700	250	60	
802990	803350	180	1800	750	250	60	
803010	803360	180	1800	800	250	60	
803020	803370	180	1800	900	250	60	
803030	803380	200	2000	700	250	60	
803040	803390	200	2000	750	250	60	
803050	803410	200	2000	800	250	60	
803060	803420	200	2000	900	250	60	



MARINA

STONIT RESINA

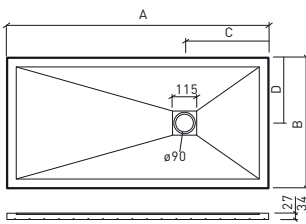

	A	B	C	D
700 a 1000	700	300	350	
700 a 1000	800	300	400	
700 a 1000	900	300	450	
700 a 1000	1000	300	500	
1000 a 1400	700	350	350	
1000 a 1400	800	350	400	
1000 a 1400	900	350	450	
1000 a 1400	1000	350	500	
1400 a 2000	700	450	350	
1400 a 2000	800	450	400	
1400 a 2000	900	450	450	
1400 a 2000	1000	450	500	

Válvula incluida
Rejilla en acero inox.
Altura del plato 2,7 cm., con marco 3,4 cm.
Peso 44 kg/m²

textura pizarra



textura granito



gris RAL 7004	negro grafito RAL 7024	gris cemento RAL 7025	chocolate RAL 8015	blanco RAL 9003
---------------	------------------------	-----------------------	--------------------	-----------------

+ colores/texturas bajo pedido



MEDIDAS STANDARD (en cm.)

textura pizarra	ancho 70 - 75 - 80 - 90	largo 70 - 80 - 90 - 100 - 110 - 120 - 130 - 140 - 150 - 160 - 170 - 180 - 190
textura granito	ancho 70 - 75 - 80 - 90 - 100	largo 70 - 80 - 90 - 100 - 110 - 120 - 130 - 140 - 150 - 160 - 170 - 180 - 190 - 200

TWOSPACE

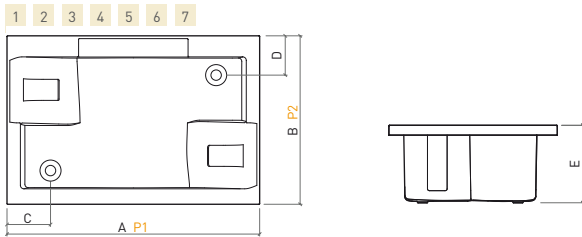

805200	1	A	B	C	D	E	
86520311	2	1800	1200	310	280	545	-
8652031100A	3	1800	1200	310	280	545	1 P1
8652031100B	4	1800	1200	310	280	545	1 P1 + 1 P2
8652031100E	5	1800	1200	310	280	545	1 P1 + 2 P2
8652031100G	6	1800	1200	310	280	545	2 P1 + 1 P2
8652031100F	7	1800	1200	310	280	545	2 P1 + 2 P2

incluida

URB.Y PLUS

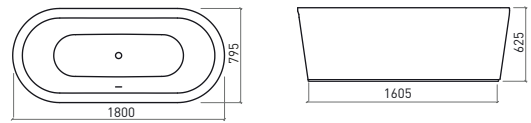

804600 50 incluida

WCA

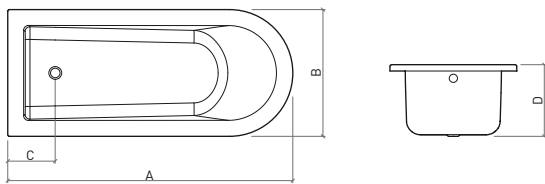

804500

A	B	C	D
1800	800	295	445

804505 50

VINTAGE

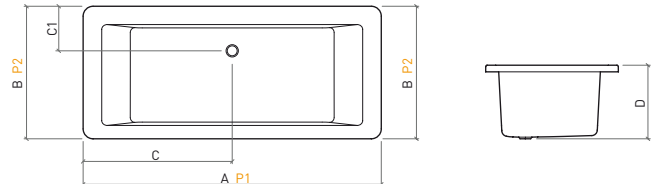

803400

A	B	C	C1	D	P1	P2
1800	800	900	235	445	803401 + 803402 / 803403	

50

URB.Y

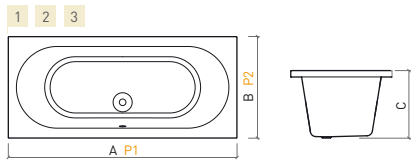

	A	B	C	P1	P2
1	807600	1700	750	530	807601 + 807602
2	807700	1800	800	530	807701 + 807702
3	807800	1900	900	530	807801 + 807802

50

VÉRTICE

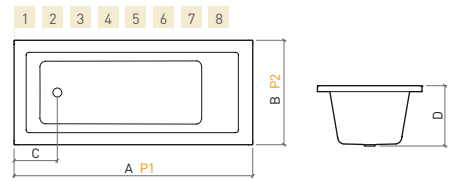

	A	B	C	D	P1	P2
1	807500	1500	700	290	385	
2	805600	1600	700	290	405	805601 + 800203
3	805700	1600	750	290	405	805601 + 800202
4	805800	1700	700	290	405	805801 + 800203
5	805900	1700	750	295	405	805801 + 800202
6	806000	1750	800	300	405	806001 + 805102 / 800302
7	806100	1800	800	300	405	805101 + 805102 / 800302
8	806200	1900	900	305	405	806201 + 806202

50

PLAN

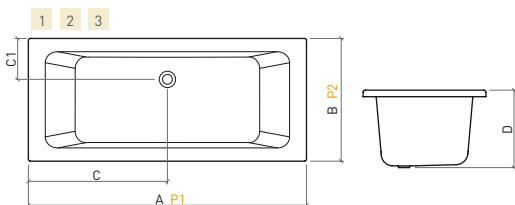

	A	B	C	C1	D	P1	P2
1	803600	1700	750	850	250	480	803601 + 803602
2	803300	1800	800	900	235	500	803301 + 803302
3	807300	1900	900	950	280	560	807301 + 807302

70

DELTA

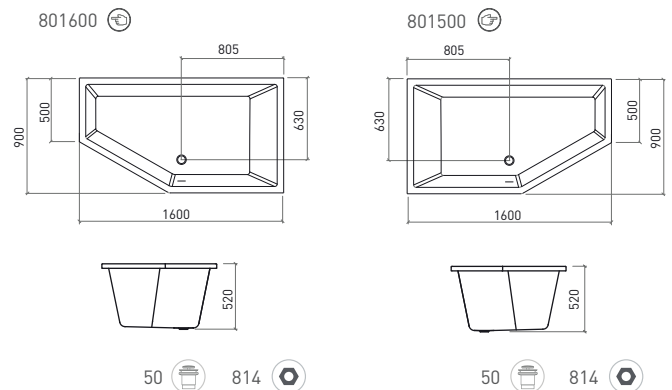

EASY

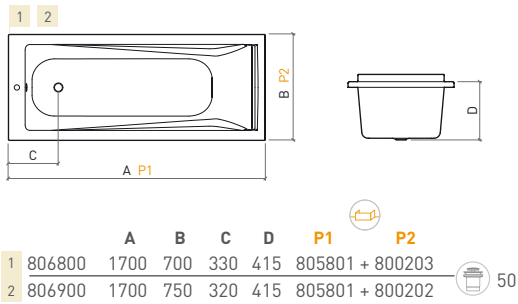

BENISSA

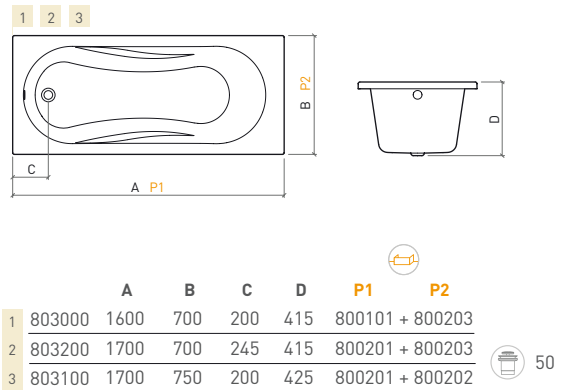



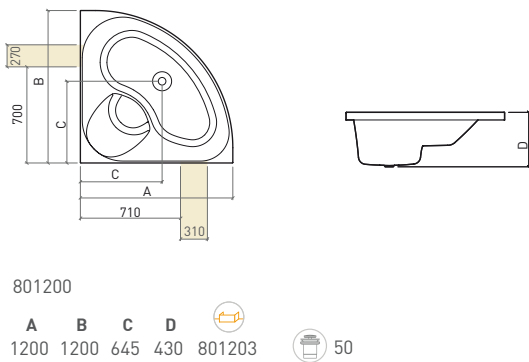

SKIN

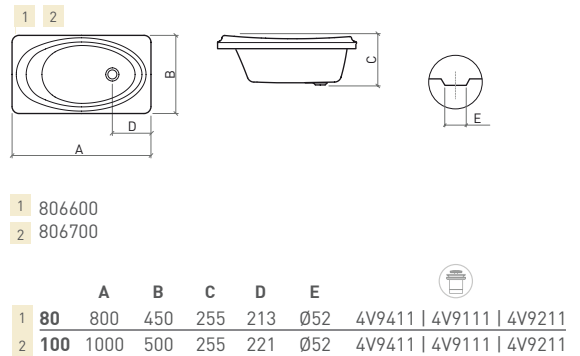

BABYBATH



-  **Sobre suelo**
-  **Encastrar**
-  **Altura reducida**
-  **Encastre plano**
-  **Antideslizante**
-  **Textura**
-  **Cara no esmaltada**
-  **Válvula**
-  **Paneles**
-  **Kit fijación bañera**
-  **Derecho**
-  **Izquierdo**



UNISAN XXI, S.A.

Avda. Mas de l'Oli, 64 · Polígono Industrial La Cova
46940 Manises (Valencia) España

tel. +34 961 545 700

unisan@unisan.es
www.unisan.es
www.tec.sanindusa.pt

sanindusa
GRUPO





SANLIFE



136720

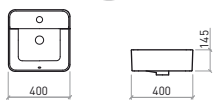

136729

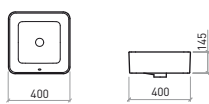

136950

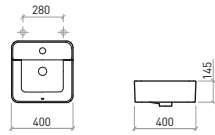

A B

136370	38	380	145
136770	42	420	145



A B

136379	38	380	130
136779	42	420	130



A B

136330	60	600	350
136340	80	800	350
136730	60	600	400
136740	80	800	400

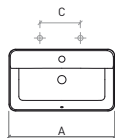

A B C

136900	60	600	350	285
136920	80	800	350	280
136910	60	600	400	285
136930	80	800	400	280

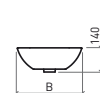
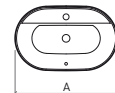

A B

136380	60	600	380
136390	80	800	380
136780	60	600	420
136790	80	800	420

A B

136339	60	600	350
136349	80	800	350
136739	60	600	400
136749	80	800	400

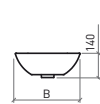
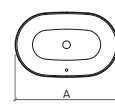
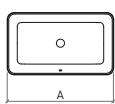

A B

136389	60	600	380
136399	80	800	380
136789	60	600	420
136799	80	800	420

SANIBOLD



* Interior blanco brillo / Exterior color mate.
Colores y acabados mate, bajo pedido.

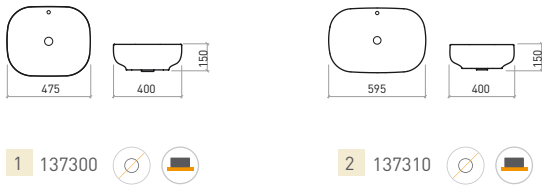

1 137300

2 137310

ROUND



* Interior blanco brillo / Exterior color mate.
Colores y acabados mate, bajo pedido.



		A	B
1	108980	40	410 150
2	108990	45	450 150

108110

UNU



109740 1
109200 2
109209 3

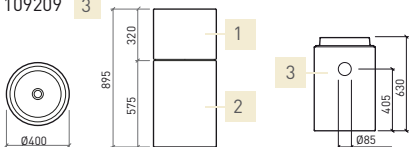

WCA



111360 111200 111202

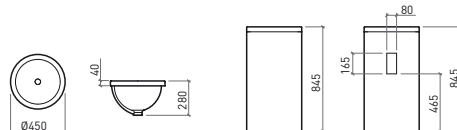

BLOK



109380

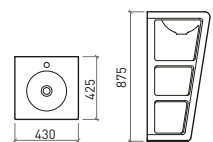

NOVELDA PLUS



Novelda Plus 50/60/70

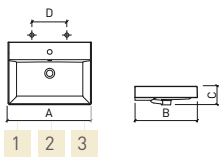

1 2 3

		A	B	C	D
1	118100	50	500	455	140
2	118110	60	605	455	140
3	118120	70	705	455	140

ÁREA PLUS - ÁREA



Área Plus 60/80

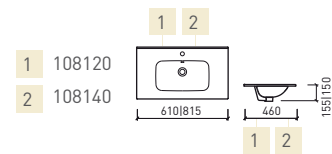

1 108120
2 108140

1 2

Área 70/90

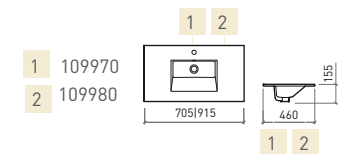

1 109970
2 109980

1 2

Área Plus 120

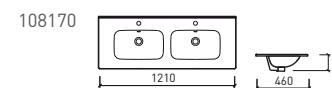

108170

Área 100

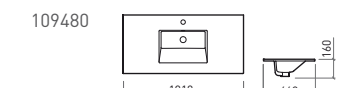

109480

FLUX



Flux 65
109750

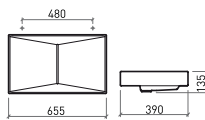

Flux 65 c/o
109700

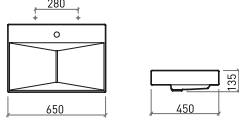

Flux 80 c/o
109760

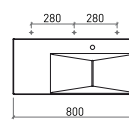

Flux 100 c/o
109780

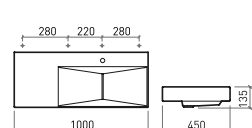

Flux 120 c/o
109800

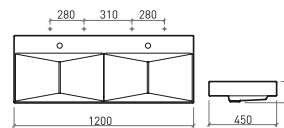

VISTA



Vista 50
109400
1T9400*

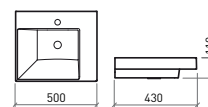

Tapa Vista

*1T9400
*1T9410



Vista 80/100

1 109410
2 109420

1T9410*

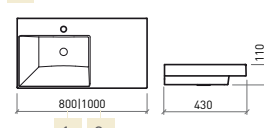

1 2

Vista 120/140

1 109430
2 109440

1T9410*

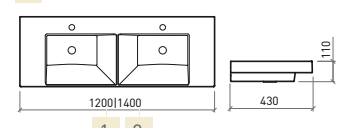

1 2

NOTE S/E



Note 36/40

1 109720
2 109340

Note 50/60

1 109360
2 109950

Note 45

109739

Note 36/45/60 c/o

	A	B	C		
1	108100	36	365	180	90
2	109730	45	450	250	200
3	109300	60	605	300	200

Note 100 c/o

109310

NOTE MURAL



Note 45 c/o

109730D 109730I 109730F

Note 45

109739D 109739I 109739F

Note 36/60 c/o

1 108100D 3 108100I
2 109300D 4 109300I

Note 60

109309D 109309I

LINHA



Linha 55/60/70/80/90

1 2 3 4 5

Linha 90 dcho.

108920

	A	B	C	D		
1	108870	55	550	450	185	285
2	108880	60	600	455	185	285
3	108890	70	700	450	180	285
4	108900	80	805	450	185	280
5	108910	90	900	445	180	280

LOOK



Look 63/83

1 2

	A	B	C		
1	134350	63	630	465	170
2	134360	83	830	465	180

Look 63/83/103

1 2 3

	A	B	C	D	E	F		
1	134770	63	630	360	160	285	---	---
2	134780	83	830	360	140	280	---	---
3	134790	103	1030	360	170	285	145	145



LOOK

134390

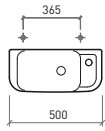

LOOK ANGULAR

134700

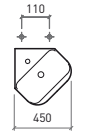

DOURO

118300

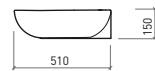
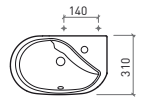

SADO

118700

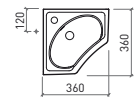

TEJO

108360

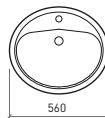

MONDEGO

108340

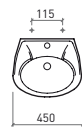

NEW WCCARE

129320

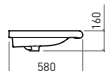
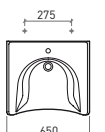

NEW WCCARE ANGULAR

129700

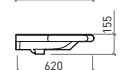
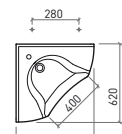



LINE 42

5550301 



LINE 42

5552301 



ADVANCE

ECOSPOT
water saving 

5270331  



MASTER 40

5250301 



TORUS

5370301 



NEW ICONE

5260301 

CETUS BASIC



5570301 

ECO TEMPORIZADA















5190341 

ECO MAN. CLÍNICA



5198341  

-  Lavabo bajo encimera
-  Lavabo sobre encimera
-  Lavabo sobre mueble
-  Lavabo de semi-encastar
-  Lavabo de pared
-  Sin rebosadero
-  Sin orificio para grifería
-  Derecho
-  Izquierdo
-  Sin VDA
-  Temporizada
-  Manecilla clínica



UNISAN XXI, S.A.

Avda. Mas de l'Oli, 64 · Polígono Industrial La Cova
46940 Manises (Valencia) España

tel. +34 961 545 700

unisan@unisan.es
www.unisan.es
www.tec.sanindusa.pt

sanindusa
GRUPO

